



6th of December 2017

Nicole Olsacher

Washington, Energy Resiliency Workshop

## Community-scale heating / cooling systems with seasonal storage and solar thermal collectors



SOLID – Who we are

Why BIG Solar Graz and how does it work?

Resilient applications – What to do

## Large scale solar thermal plants (> 1 MW)

- Planning
- Plant installation
- Solar thermal collectors (manufacturer independent!)



## .... and services!

- Operations (remote monitoring, maintenance)
- Finance (national & international)
- Research & development
- Consulting

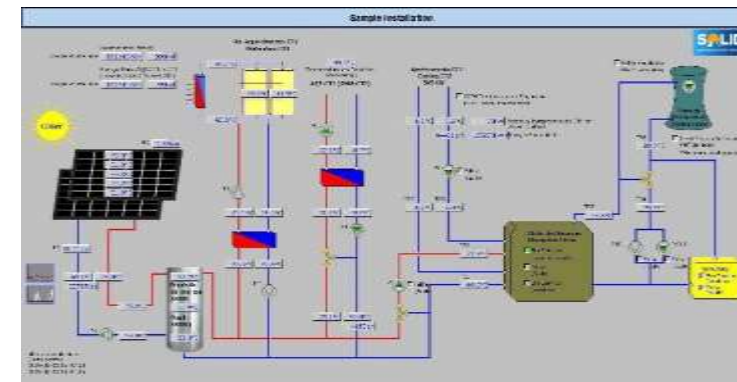

**➔ SOLID is the only full service provider for solar heat and cold**



**Solar Heating**  
**Solar Cooling**  
**Solar Process Heat**  
**Solar District Heating**



**25 YEARS OF EXPERIENCE IN LARGE SOLAR THERMAL SYSTEMS**  
**300 PLANTS IN 20 COUNTRIES**  
**SUBSIDIARIES IN USA, SINGAPORE, GERMANY**

# Desert Mountain High School, USA

Solar Panels: 52,400 ft<sup>2</sup> → 3.5 MW

Cooling load: 500 tons /1750 kW

ESCO, In operation since 2014



**World's most powerful Solar Cooling System**



SOLID – Who we are



Why BIG Solar Graz and how does it work?

Resilient applications – What to do

# Case study Graz, Austria

## Overview of Graz

- The second largest city of Austria
- Approx. 300.000 inhabitants
- Approx. 120.000 people supplied by district heating

## Actual situation:

- Peak load: 530 MW
- DH demand: 1.200 GWh/a

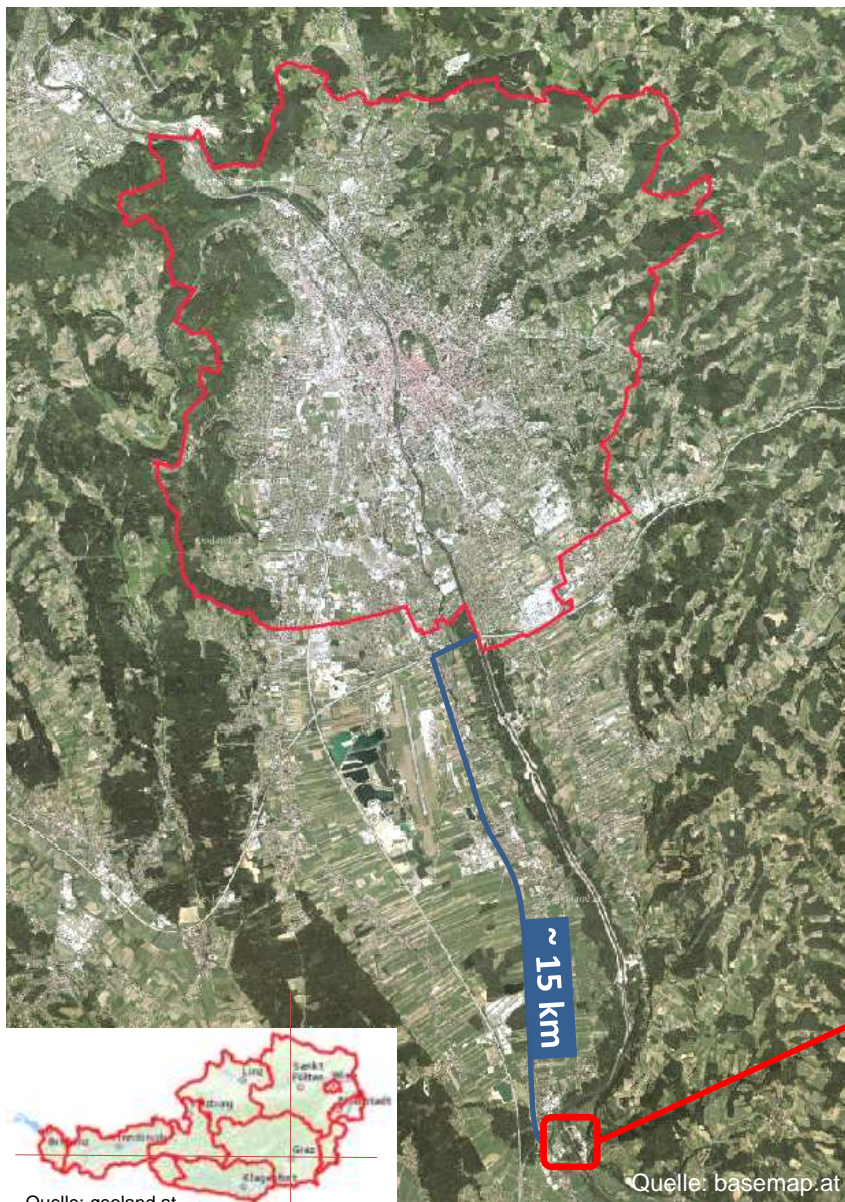

# District heating in Graz

approx. 400 MW NEW are necessary

Heat supply Graz  
2020 / 2030  
Conversion of district  
heating

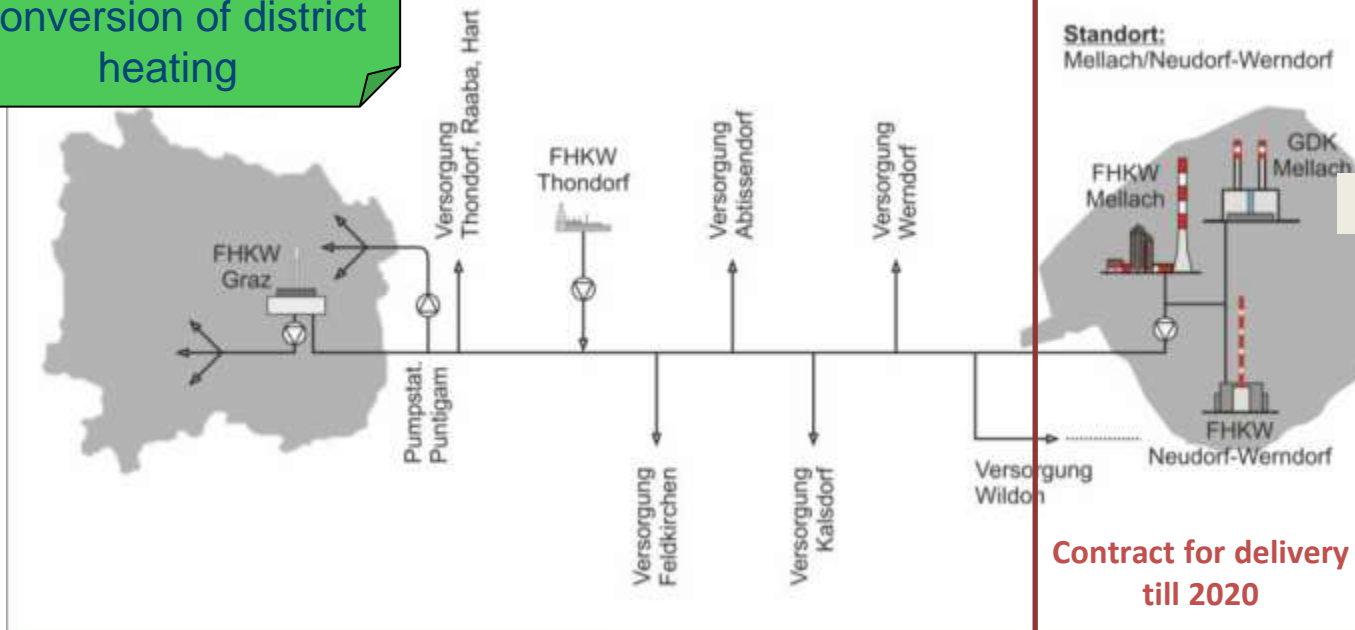

## District heating Graz: 2020 ?!

2014  
86% of Energy provided  
by Mellach

Standort:  
Mellach/Neudorf-Werndorf



Electricity market <-> gas price

GuD 400 MW<sub>th</sub>  
800 MW<sub>el</sub>

Contract for delivery  
till 2020

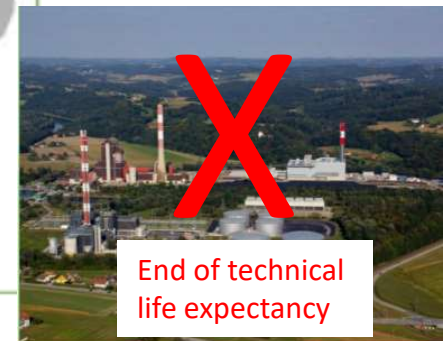

Coal-fired power station  
230 MW<sub>th</sub>  
226 MW<sub>el</sub>

Source: E-Stmk, C. Hackl, Vortrag: Erfahrungen mit Solar-Wärmeeinspeisung in Graz, 27.05.2015

Source: Wärmeversorgung Graz 2020/2030, Workshops



# Requirements to systems relating to energy supply security

- Reliable technical operation: available energy at anytime
- Security of supply with independent long term energy supply
- Affordable energy provision and economic competitiveness

# System concept of BIG Solar Graz



- second largest city of Austria
- 300.000 inhabitants

# System concept optimum of BIG Solar Graz

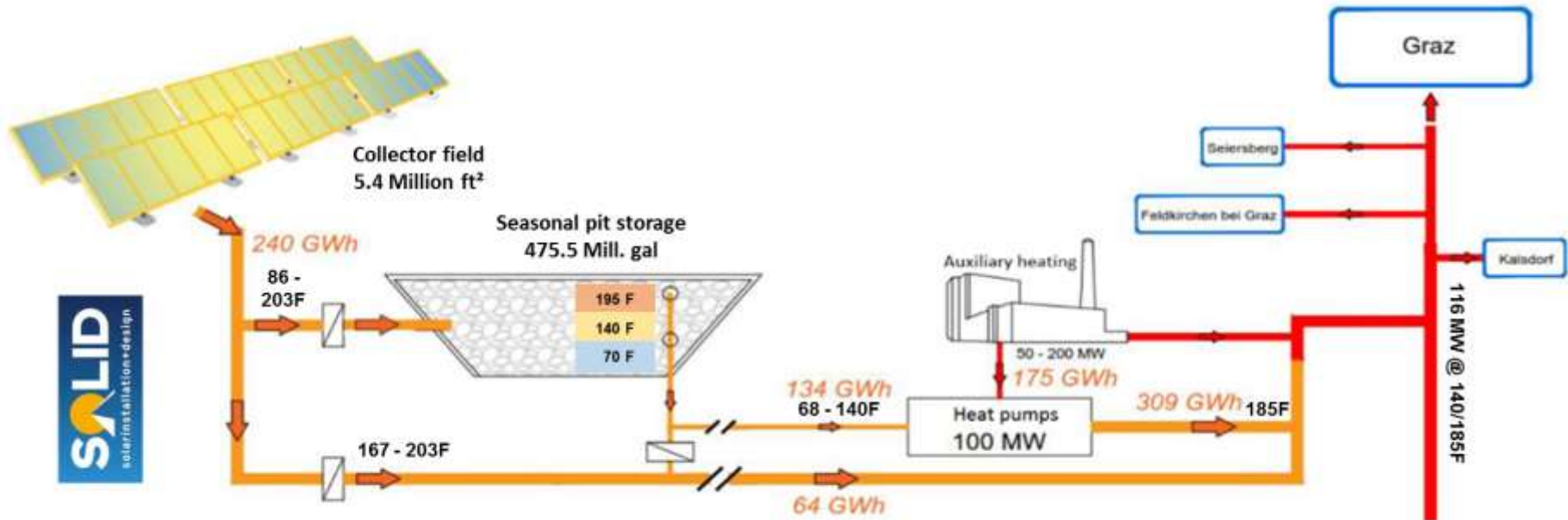

Solar coverage:

Total capital expenditures:

Annual avoided CO<sub>2</sub>-emissions:

approx. 20 %

approx. 200 Mio. EUR

approx. 50,000 t CO<sub>2</sub>

SOLID – Who we are

Why BIG Solar Graz and how does it work?

 Resilient applications – What to do

## Solar coverage of annual district heating demand today:

Canada: > 90% in Drake Landing



Source: DLSC

Denmark: 20-50% in several small cities



Source: PlanEnergi

Austria: 20% Big Solar Graz, up to 12% in several DH grids

# Why intelligent DH grids

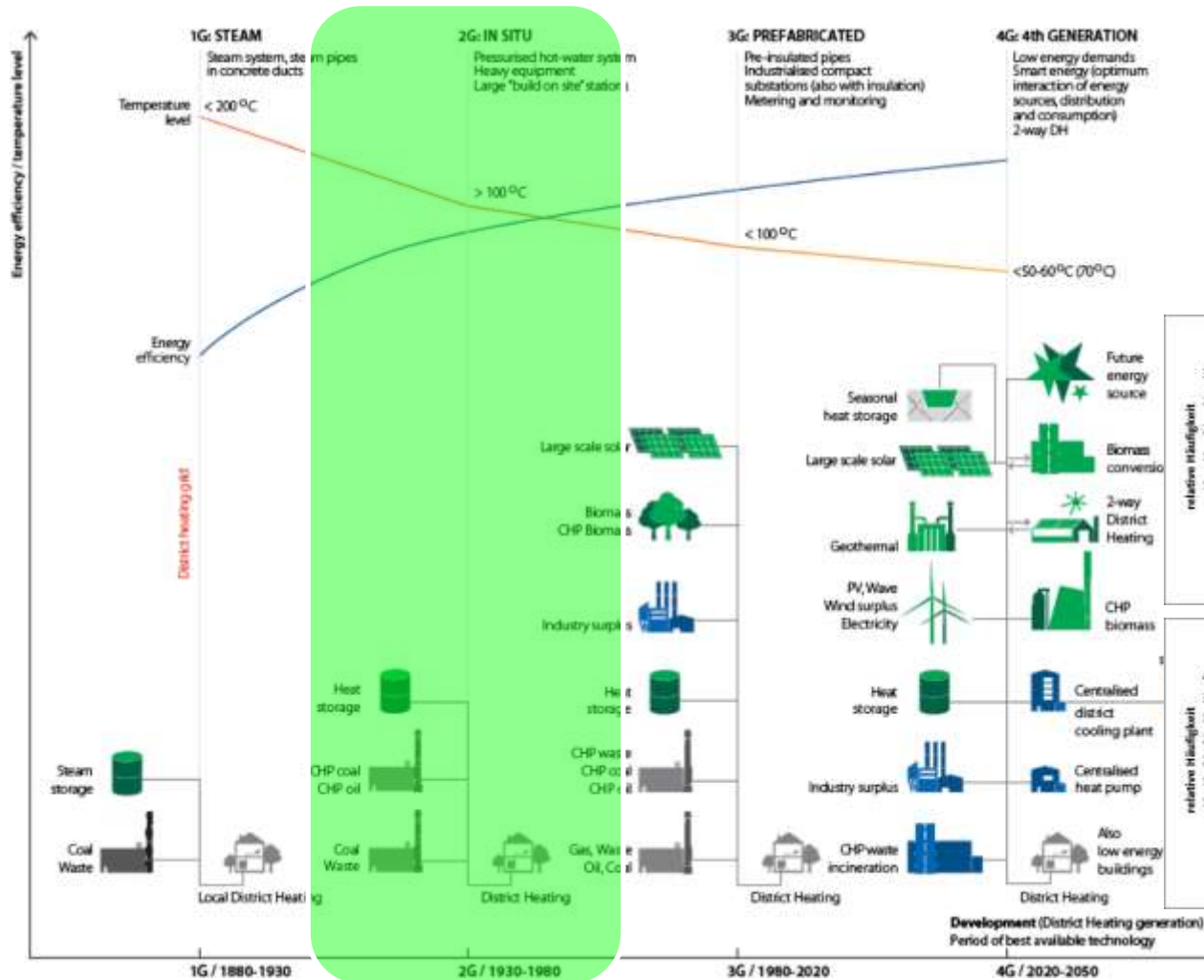

**District heating network from the 60ies**  
with high temperatures:

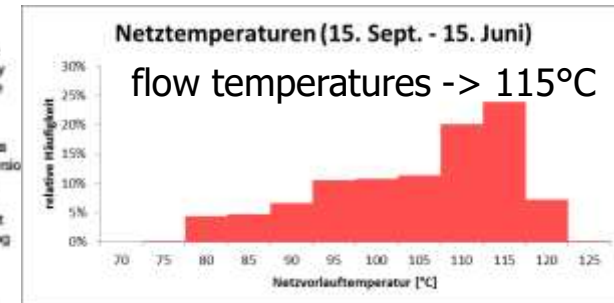

Source: Henrik Lund, 4th Generation District Heating (4GDH)

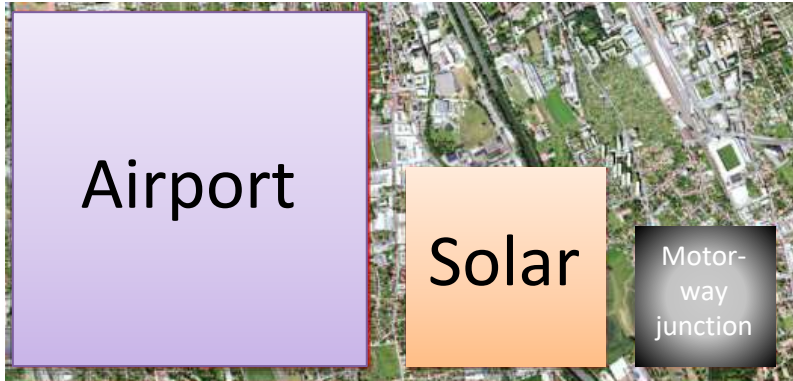

**Required solar system area  
< 0,8 % of the city area**

**Needed space for  
fast growing biomass  
for same energy output**

factor of 30

## Comparison to other infrastructure areas in Graz

Airport Graz	~ 740 acres
Motorw. junc. Graz Webling	~ 99 acres
Generation System Mellach	~ 270 acres
Big Solar concept	~ 247 acres

**Conventional biomass  
floor space requirement  
for same energy amount**

factor of 55

## Energy costs:

- With BIG Solar system we are competitive to big industrial heat generation costs
- Prices: gas versus solar heat
  - Today: solar 0-20% more expensive, but stable price
  - In 20-25 years: raise of gas price, solar price still stable

## Financing costs:

- Higher Investment costs for solar system
- Provision of project financing
- No risk of energy cost fluctuations

**→ 15-20% higher costs for a resilient system!**

**→ Higher Investment now for long-term resilient system!**



- Reliable technical operation: available energy at any time
  - Best practice examples existing
  - Intelligent DH grids needed
- Security of supply with independent long term energy supply
  - The sun – an infinite resource without CO<sub>2</sub> emissions
  - Reduction of dependency of (imports of) fossil fuels
  - High energy output per ft<sup>2</sup> collector area, but floor space required
- Affordable energy provision and economic competitiveness
  - Low maintenance costs
  - Long-term price stability
  - Independent from the development of prices of fossil energy sources
  - Investment needed today to benefit „tomorrow“

# Thank you for your attention!



## SOLID GmbH

Puchstrasse 85, 8020 Graz, Austria  
CEO: Christian Holter & Franz Radovic  
Tel: +43 316 292840-0

[office@solid.at](mailto:office@solid.at)

<http://www.solid.at>

## SOLID California Inc.

4850 Pacific Highway, Suite 110  
San Diego, CA 92110  
C: (619) 718 1641

[office@solid-ca.com](mailto:office@solid-ca.com)

<http://www.solid-ca.com/>



Solar heat for industrial processes by SOLID: Gatorade, USA