

**INTERNATIONAL ENERGY AGENCY**  
energy conservation  
in buildings and community  
systems programme

**annex I**  
**computer modeling of**  
**building energy performance**

**results and analyses**  
**of**  
**Avonbank Building simulation**

**level 2**

**IEA**  
**ENERGY**  
**CONSERVATION**

**april 1980**

x

Ann 1 1980:1

~~7/2 (Qual 2)~~

---

**results and analyses  
of  
Avonbank Building simulation**

**level 2**

**prepared by  
Oscar Faber and Partners  
St. Albans  
U.K.**

**IEA  
ENERGY  
CONSERVATION**

**april 1980**

X

# ENERGY CONSERVATION IN BUILDINGS AND COMMUNITY SYSTEMS

## ANNEX I

### RESULTS AND ANALYSES OF AVONBANK BUILDING SIMULATION

APRIL 1980

---

#### Executive Summary

This report summarises work carried out under Annex I of the IEA implementing agreement on Energy Conservation in Buildings and Community systems. Participants from several countries used eleven different computer programmes to predict the energy flows within the Avonbank office building near Bristol, England. Detailed architectural and systems specifications were prepared which were used by the participants to model the building. The answers of the computer programmes were compared with the performance of the real building as determined by monitored data.

The major conclusions arising from the work described in this report are that at present state of the art, there are still several areas where the simulation of building energy transfer processes need further development. These are:

- i. Coupling effects across zone boundaries
- ii. Infiltration
- iii. Building storage effects

X

## CONTENTS

	Page No.
Executive Summary	i
Participants	iii
1 Introduction	1
2 The Avonbank Building	2
3 Monitored Data	2
4 The Comparison Exercise	4
5 Modelling Assumptions	5
6 Comparison of Whole Building Performance	7
7 Comparison of Results for First Floor of Avonbank Building	8
8 System Simulation	9
9 Summary and Conclusions	10
10 Acknowledgements	10
11 References	11
Figures 1 to 10	12/21
 <b>APPENDIX 1</b>	
1 Introduction	22
2 The Avonbank Building	22
3 HVAC Systems	23
4 Operating Schedules	25
5 Weather Data	26
6 Computer Runs	27
Table 1 – Details of Zones	28
Table 2 – Details of HVAC Systems	29
Table 3 – Thermal Storage Tank Data	29
Table 4 – Capacity of Chilled and Warm Water Circuits	30
Table 5 – Lighting Profiles	30
 <b>APPENDIX B</b>	
Table B1 – Thermal Properties of Building Fabric	32
Table B2 – Surface Heat Transfer Properties	33
Table B3 – Glass Properties	33
Table B4 – Heat Gains	33
Figures 1 to 21	34/59
 <b>APPENDIX 2 – Recommendations</b>	 60

X

## PARTICIPANTS

Tabled below are the various organisations who have participated in the work of the annex.

U.S.A.	G. Leighton	Department of Energy Washington DC 20545 U.S.A.	202-376-4714/229249
U.K.	D. M. Curtis	Oscar Faber and Partners Upper Marlborough Road St. Albans Herts.	727-59111/889072
U.K.	Phil Jones	Welsh School of Architecture Research and Development University of Wales, Institute of Science and Technology 28 Park Place Cardiff	0222-24733
U.K.	M. Barnett	Environmental Advisory Service Pilkington Brothers Ltd West Park St Helens Merseyside WA10 3TT	0744-28882 X636
U.K.	W. J. Bennett	British Gas Corporation Watson House Peterborough Road London SW6 3HN	01-736-1212 X347
U.K.	J. Cockroft	Building Services Research Unit University of Glasgow 3 Lilybank Gardens Glasgow G12 8RZ	041-334-2269/778421
U.K.	A. Iqbal	Atkins Research and Development Parkside House Ashley Road Epsom Surrey	03727-26140 X2869
U.K.	J. Campbell	Ove Arup and Partners 13 Fitzroy Street London W.1	01-636-1531
U.K.	A. Ashfield	Haden Young Ltd. 141 Euston Road London NW1 2AY	01-387-4377
U.K.	J. Clarke	Department of Architecture Strathclyde University Glasgow G4 0NG	041-552-4400 X3013
Sweden	A. Boysen	Swedish Council for Building Research Sit-Goransg. 66 S-11230 Stockholm Sweden	85-540640
Switzerland	P. Hartmann	EMPA Ulberlandstrasse CH 8600 Duebendorf Switzerland	01-820-8131 X517

Holland	R. Soeleman	TNO Research Organisation 97 Schoemaker Street PO Box 214 Delft The Netherlands	015-569330 X2413
Canada	L. Jones	National Research Council Ontario K14, 0R6 Canada	613-993-1421
Greece	E. Carabateas	National Energy Council of Greece Ministry of Coordination Syntagma Square Athens Greece	3248181 Athens
Italy	F. Butera	C.N.R. Universita di Palermo Istituto di Fisica Tecnica Viale delle Scienze Palermo	091/44780 091/44781 091/44782 Tlx 220646 POLITO 1
Germany	A. Dutz	Kernforschungsanlage Julich Projektleitung Energie- Forschung KFA Julich/PLE Postfach 1913 D-5-70 Juelich	02461/614817 Tlx 833556b KGA D.
Belgium	J. Lebrun	Laboratoire de Physique du Batiment Institut de Mathematique 15 Avenue des Tilleuls B 4000 LEIGE Belgium	41/520180 X367
Denmark	J. Lemming	Thermal Insulation Laboratory Technical University of Denmark Building 118 DK-2800 LYNGBY Denmark	02-883511
Austria	F. Panzhauser	Technical University of Vienna A-1010 Wien Gasshausstrasse 25 Vienna Austria	02221657611/1281

# IEA EXECUTIVE COMMITTEE ON ENERGY CONSERVATION IN BUILDINGS AND COMMUNITY SYSTEMS

## Annex I – Methodologies for Load/Energy Determination of Buildings

### Report on the Avonbank Energy Analysis Project

---

#### 1. INTRODUCTION

The analysis of the energy consumption of the Avonbank office building is a distinct sub task of the Annex I effort of the IEA R&D project on Energy Conservation in Buildings and Community Systems. The overall aim of the annex is

“to evaluate a number of different approaches to modelling the energy requirements of commercial buildings.”

The first sub-task was a comparison of the thermal loads of a simple “model building”, using nineteen computer programmes from nine participating countries. This work has been fully documented in a separate report published under the annex (Reference 1). This initial exercise helped identify the energy transfer processes which result in the different programme methodologies to diverge. These are

- the modelling of the thermal storage effects of the building fabric
- the related aspect of assumptions made about the convective-radiant split of the room heat gains
- the level of detail used in modelling the interior heat exchanges.

This first exercise indicates that significant differences do exist between the various program methodologies, but it cannot give any indication as to which methodology most realistically models the real world. Consequently, a separate task was set up under the annex, so that the same computer programs would be used to simulate a real commercial building, the Avonbank Office block near Bristol, England. The South West Electricity Board, the building owners, had carried out some fairly extensive monitoring of the thermal behaviour of the building, and this data was made available to participants in the annex.

The work on the Avonbank building was intended as the first stage in modelling real building behaviour. A separate annex (Annex IV) has been established with the sole aim of monitoring a commercial building, and using the data to validate computer programs used for energy predictions. During the time when this monitoring exercise was being set up, it was felt that time could usefully be spent on investigating another commercial building for which some monitored data was available. This would help highlight any potential problems in monitoring and predicting real building behaviour, which could then be used as an input to the specification of the instrumentation required for the Annex IV monitoring exercise.

This report relates to the work carried out by the various participants in modelling the Avonbank building. It is intended as an overall summary report, to bring together the results of the several participants, and to highlight the conclusions and recommendations for future work that arise from the studies.



## 2. THE AVONBANK BUILDING

The Avonbank building is an all electric air conditioned office building on three floors. The building is basically a rectangular concrete box, with holes shuttered for the repetitive windows. The important aspects of the building construction are

- the low glazing area (12% of the facade)
- the relatively large mass of the structure
- the wall insulation is on the inside of the building fabric

A complete building specification has been prepared as part of the work carried out under the annex, and is included as Appendix 1. This specification also included details of the air conditioning systems used at Avonbank. Again, the detail is included in Appendix 1, but a brief description follows.

The Avonbank building is conditioned using fan coil units distributed through the building. The fan coils fall into two groups

- cooling only units in the core areas
- heating and cooling units in the perimeter

Air is drawn from the room through ventilated light fittings, mixed with fresh air where provided (mainly in the core areas), passed over the fan coil and returned to the space via ceiling mounted slot diffusers. All the circulating air, plus the fresh air is returned to the space, the excess air being extracted through the toilet areas. Humidity control is achieved by supplying the fresh air from a central plant at a fixed condition of 10.5 DB, 10.0 WB, and extracting the room air.

The fan coil units operate on a three pipe system, i.e. warm and chilled water supplies, with a common return. The chilled water is supplied from a refrigeration plant, the warm water being supplied from a heat recovery/storage system. Back up heat is available from immersion heaters in the water storage tanks.

## 3. MONITORED DATA

The monitored data which is required as input to the study falls into two main sections, relating to

- building and systems performance
- external weather and climate

### 3.1 Building and Systems Performance

The building performance has to be determined from measurements of air and fabric temperatures, energy inputs to lights and equipment, and temperatures in the primary warm and chilled circuits. The following measurements have been made.

- space temperatures — both air and mean radiant
- fabric temperatures — gives the temperature profile through the elements of the fabric construction
- fan coil units — inlet and outlet air temperatures
- hot and chilled water temperatures — flow and return pipes
- electrical consumptions — to immersion heaters  
— lights and power (in separate zones)  
— domestic hot water  
— lifts  
— chillers

During the occupied period, these parameters are measured on a half hourly basis, but at night the data is only recorded every hour.

Unfortunately, the selection of measurement parameters and choice of sensor was not selected with the primary aim of comparing measured building performance with computer predictions. Consequently there are problems with backing out the required information from the measured data. The major difficulty arises in estimating the rate of heat extraction from the fan coil units, since although the inlet and outlet temperatures are measured, the air flow rate is an assumed value based on the commissioning data. Basnett (Ref 3) has made an estimate of the likely total errors that are involved in the calculation of the energy transfer process; these estimates are shown below.

Range of Daily Requirement kWh	Error in Daily Requirement %	Error in Peak Requirement %
0 - 10	± 100	± 75
10 - 100	± 40	± 40
100 plus	± 20	± 25

Eight fan coil units have a capacity in excess of 100 kWh/day and account for about 80% of the cooling load of the building, and so the range of potential errors in the measured performance of the building is of the order of ± 25% for the daily requirements, and ± 30% for the peak requirement. The problem is exacerbated by faulty channels on the data logging equipment, notably a temperature channel on one of the large fan coil units on the second floor, in the south core zone. In such cases, the performance of the unit concerned has to be estimated from the performance of similar units.

### 3.2 Weather Data

The data monitored at the Avonbank site included very little in terms of the outside climate. Outside air temperature was measured, but the minimum requirements for input to a building simulation are

- outside air dry bulb temperature
- outside air wet bulb temperature
- direct solar radiation
- diffuse solar radiation

Additional information which is of value include

- wind speed
- wind direction
- atmospheric pressure

The normal time step for computer simulation is one hour and so it is necessary to provide this data on an hourly basis. A weather tape for the complete year of 1973 has been prepared by combining data from two weather stations within about fifteen kilometres of Avonbank. The components of the data, and the relationship of the measuring station to the Avonbank site are set out below.

- Avonbank 51° 27' N, 2° 34' W
- Long Ashton – solar radiation data 50° 26' N, 2° 41' W
- Filton – all other weather data 51° 31' N, 2° 35' W

There is evidence that there are some problems inherent in combining data from different sites, particularly with regard to the solar radiation data. The measured data from Long Ashton provides total radiation on a horizontal surface; this value can be compared with the cloud cover index recorded at Filton, and some discrepancies are apparent, mainly during periods of patchy cloud. Although the solar radiation value used for Avonbank may be somewhat distorted at any particular hour, it would be expected that the longer term average would be fairly close. Because the Avonbank building has a relatively small area of glazing, any errors are likely to be of secondary importance relative to the problems discussed previously.

### 3.3 Analysis Periods

Although building performance and weather data was available for the whole of 1973, it was decided to only analyse two two-week periods, one in the summer and one in the winter. The reasons for this decision were as follows:

- to choose analysis periods where there was a full set of recorded data – ie a minimum of faulty channels
- to reduce to a meaningful minimum, the amount of data that would have to be processed, and the quantity of results that would have to be analysed and compared.

The periods selected were January 6 - 19 inclusive, and July 14 - 27 inclusive, with the last day of each period being chosen for more detailed study of the hour by hour variation in heat extraction rates.

## 4. THE COMPARISON EXERCISE

The comparison exercise falls into two main areas

- the comparison of the various computer programmes, and the level of agreement they achieve in predicting the energy flows within the Avonbank building.
- the comparison of the computer simulation with the monitored behaviour of the real building.

The major concern of this part of the Annex I activities relates to the latter aspect of the comparison exercise, and will be the major concern of this report. However it is evident that the first aspect is also important and will be discussed in relation to the conclusions of the IEA-O exercise reported in reference 1.

### 4.1 Terminology

A consistent problem which has occurred throughout the comparison exercise is the definition of terms. A terminology was agreed by participants within the annex, and will be used consistently in this report. The terms relate to the components of the energy flows into and away from a space, and are defined as follows.

- Space heat gain – the rate at which heat enters into and/or is generated within a space
- Cooling Load – the rate at which heat must be removed to maintain the space air temperature constant over the full 24 hours of the day
- Heat Requirement Rate – the rate at which heat must be removed from the space to maintain a given room air temperature (not necessarily for the full 24 hours).
- Heat extraction rate – the heat extracted from the space each hour under the specified system of control (ie the space temperature may float within a specified band).

### 4.2 Reporting Formats

Reporting formats were circulated whereby the results of the various computer simulations and the monitored building could be recorded in a consistent manner. In terms of real building performance, the only energy flow that has any real meaning is the heat extraction rate and it is on this basis that the Avonbank results are discussed.

The building was broken down into a number of separate zones corresponding to the separate floors, each floor being divided into 4 perimeter zones (corresponding to the orientation of the facade) plus 2 core zones. Because of the vast quantity of data that arises from

analysing such a large number of zones, the report will concentrate on a consideration of two main areas.

- the performance of the whole building
- the performance of the first floor

Even the comparisons at these fairly basic levels are complicated by the way the system provides the heat extraction rates. The system provides cooling in two ways; firstly, the local zone fan coil unit extracts heat to maintain space conditions, but this is supplemented by cold conditioned air from the fresh air unit in the roof top plant room. Because several of the programs found it difficult to separate these two components, one of the levels of comparison was the zone heat extraction rate — ie the duty of the fresh air unit was added to the duty of the local zone fan coil unit in proportion to the ratio of the zone fresh air to the total fresh air. A second level of comparison is the heat extraction rate of the individual fan coil units. Similar results have been determined for the real building based on the measured performance of the various fan coil units. The likely accuracy of these results has already been discussed in a previous section (3.1) but before the building could be analysed it was necessary to make additional assumptions and estimates about the building behaviour. These assumptions are the subject of the next section of this report.

## 5. MODELLING ASSUMPTIONS

Before the thermal behaviour of a building can be estimated using computer techniques, it is necessary to have a complete description of the heat transfer processes taking place within the building envelope, and through that envelope to the external environment. In many instances the parameters which control these heat exchanges can be fairly well defined eg. conductivities of the fabric, transmission of solar radiation through glass etc. However some of the heat transfer processes are only poorly understood, and therefore crudely modelled. The main area of uncertainty is convective heat transport, and this problem manifests itself in three main areas within the Avonbank building.

### 5.1 Convective coupling between Zones

Each floor of the Avonbank building is divided up into a number of small zones which correspond to areas served by the separate fan coil units. These zones are not architectural compartments ie. there is no physical partition defining the zone boundary, and so it is clear that there will be a convective coupling effect across the zone boundary. This problem is of particular importance during the heating season, when there is a heating requirement in the perimeter zone, but due to the high internal space heat gain (mainly from the lights) there is still a cooling requirement in the core areas. In the real building situation it is evident that the convective coupling will achieve some partial compensation of the conflicting fan coil duties. In computer simulation it is very difficult to allow for this interzonal mixing effect, and so the participants modelled the zones as completely separate entities. The weakness of this approach is emphasized by the intermittent operation of the plant. When the plant switches off, and the space conditions drift, the temperatures in the perimeter fall off much more rapidly than in the core. Consequently when the plant switches on again in the morning, the programs often predict a significant temperature difference across the zone boundary — a situation which would be impossible in practice.

### 5.2 Infiltration

The rate of infiltration has never been measured at Avonbank, and this quantity is impossible to predict to any degree of accuracy with the present state of knowledge. The Avonbank building was designed on the assumption of 0.25 air changes per hour, and this value has been used by the analysts in modelling the building. It is obvious that the importance of any error in this assumption is magnified the greater the difference between the enthalpy of inside and outside air. As the outside condition reaches the winter design condition of  $-10^{\circ}\text{C}$  saturated, the effect of the infiltration on the space heat gains is very significant. This can be illustrated by the table below, listing the heat gains for the first floor east perimeter zone, using a simple steady state calculation

Space Heat Gain	Value MJ/hr
Infiltration	-20.0
Lighting	+12.6
Occupancy	+ 8.2
Small power	+ 5.4
Conduction	-13.7
TOTAL	- 7.5

It can be seen that the assumed infiltration rate results in a heat gain to the space nearly three times bigger than the nett space heat gain, and so any error in the infiltration value will have a very significant effect on the calculated values of the heat extraction rate. This effect is obviously reduced as the outside condition approaches the controlled space conditions, and is therefore of major concern during the winter analysis period. During the two week period chosen for the analysis, the outside condition typically varies each day from about 1°C DB, 0.3 WB to 5°C DB, 3.5° WB. From these simple calculations it can be seen that the error in the calculated heat extraction rate for a perimeter space may be significant if the real infiltration rate is substantially different from the assumed value of 0.25 air changes per hour. The low infiltration rate of 0.25 air changes per hour was used as the building is slightly pressurised. However the windows are openable and so there may be significant crackage in the external facade.

Since the results of the simulation exercise are being compared at floor level rather than individual zone level, it is useful to summarise the effect of infiltration on the space heat gains of an intermediate floor at the winter design condition.

Space Heat Gain	Value MJ/hr
Infiltration	- 59.9
Lights	178.9
People	78.3
Small power	50.8
Conduction	- 43.3
TOTAL	204.8

It can be seen that even on a per floor basis, an error of 100% (which is quite possible) in the assumed infiltration rate would give a difference between measured and calculated heat extraction rate of 40% at the winter design condition.

### 5.3 Fresh Air Supply

The third major uncertainty in the heat transfer processes is the fresh air supplied to the individual zones. The fresh air flow rate to the various zones was never measured during the monitoring process. The flowrates used by the analysts were design values which were set up when the system was commissioned, but never rechecked. There are two potential sources of error –

- (a) the total fresh air flow has changed – eg due to increased resistance at filters etc.
- (b) the distribution of the air to the separate zones has changed, although the total may have remained fairly constant.

In order to assess the importance of the space heat gain due to the fresh air supply, the enthalpy change of the fresh air input to the first floor is 48 MJ/hr. When compared with the table in section 5.2 showing the space heat gains for the first floor, it is evident that unless there are very major differences in the assumed and actual fresh air flow rates, then the effect on the space heat gain will be of secondary importance.

## 6. COMPARISON OF WHOLE BUILDING PERFORMANCE

The first level of comparison of the programme predictions and actual building performance is the comparison of total heat extraction rates for the whole building

- for each day's total for the winter and summer period
- for each hour of the selected winter and summer days

### 6.1 Building Daily Total Heat Extraction Rates

Fig 1 shows the results for each day of the winter analysis period for the measured building performance, and three of the programmes participating in the comparison exercise. These three sets of results have been chosen to illustrate typical variations which exist in terms of the computer predictions —

- Program C represents the set of results which most closely follow the measured performance over the winter period
- Program K represents the set of results which define the upper limit of both calculated heating and cooling duties
- Program H represents the set of results which represent the lower limit of both calculated heating and cooling duties

Fig 2 shows the same four sets of results, but this time plotted for the summer analysis period. Clearly the program predictions are clustered much closer together, but significantly removed from the measured performance, particularly during the first week of the period. Based on these curves, a number of observations can be made, which help to identify certain potential areas of divergence.

- (i) In winter, the programs tend to underestimate the heating but the average results for the programs tie in reasonably well with the measured winter cooling.
- (ii) In summer, the programs consistently under-estimate the cooling requirement (there being virtually negligible heating requirement).

The reasons for these effects can largely be explained in terms of the modelling uncertainties discussed in section 5.

- the major component of the heating demand is infiltration — if the assumed value is too low, then the programs will consistently underestimate the heating duty.
- \* in the summer period, the programs underestimate cooling. This is not due to the infiltration assumption, because the inside/outside temperature difference is small. If there is a basic fault in modelling the cooling process, then the fact that there is general agreement in the winter between the measured and the average program result, implies there is a second effect masking the error due the cooling. This second effect is very likely due to the convective coupling across zone boundaries. The convective coupling effect will tend to cancel out the excess heat in the core areas with the perimeter heat loss. It is perhaps not without significance that program K is the only one of the three whose results are shown that modelled all the zones as specified. Programs C and H combined all the zones on each floor, and so provide the opposite extreme in terms of modelling assumptions. In the summer when there is a minimal perimeter heating requirement, the cancelling effect is irrelevant, and the programme predictions come much closer together. The only problem with this interpretation is that it might be expected that programmes C and H would be closer together as they are both modelling the same problem, and both are detailed numerical models. The reason for the difference between these two programmes is not clear.
- It has been suggested that the reason for the underestimate of the cooling duty is caused by latent cooling which is taking place on the coils. The way the system is designed, all the latent control should be done by the fresh air unit, and the zone fan coil units should be "dry". However if a calculation is made on the psychrometric processes going on around the fan coil unit it seems very likely that in order to extract the required sensible load, then some moisture will also be removed. (see Fig 3). This process is even more likely when the coil surface temperature is considered; the temperature of the circulated chilled water is only 6.5°C and so the coil surface temperature will be well below the dew point of the air passing over the coil.

The points discussed above only relate to the differences that exist between measured and predicted building performance. The results show that there are very significant differences between the program predictions, particularly during the winter period. The reasons for these differences are not readily apparent, because of the multizonal nature of the problem, and the consequent addition of the different effects. The differences between programs will be discussed in greater detail in a later section, when considering a single floor where the individual effects can be seen. g

## 6.2 Building Total Heat Extraction Rates – Hourly Variations for Selected Day

Participants reported the hour by hour variations in heat extraction rates for a selected day in both the summer and winter analysis periods. The intention of this approach is to bring out the fine detail of the variations in the simulations, but again at the total building level, the fine detail is obscured by the summation of several effects in the individual zones. However the same general trends are apparent on an hourly basis, as are evident on the daily basis. This implies that the reason for the variation in individual sets of results is a consistent one over the whole analysis period.

## 7. COMPARISON OF RESULTS FOR FIRST FLOOR OF AVONBANK BUILDING

The first floor of the Avonbank building has been selected for a more detailed study of hour by hour variations in heat extraction rates. The problem of comparing results is increased by the fact that some participants modelled all zones separately, some combined all the zones on one floor. In order to bring all the results to a common level, the nett floor heat extraction rates at each hour have been plotted for the winter and summer selected days (Figs 4 and 5).

### 7.1 Summer selected day 7 8

During the summer selected day, there is never any heating demand. Since all the fan coil units are on a cooling only duty, the zoning effects are of lesser significance at this time. As with the total building loads, the basic shape of the curves is similar. The IEA- $\emptyset$  exercise has shown that building storage effects were very significant in determining the calculated heat extraction rates. Storage effects could explain the relative magnitude of the peaks predicted by the programs, and so figure 6 was prepared to test this hypothesis. The plot of annual cooling demand/annual heating demand should show a trend line of increasing cooling with increasing heating, as the storage effects of the building are reduced. Fig 6 shows this curve for the sum of the winter and summer analysis periods, and a significant trend is seen. This curve ties in very well with the results for the selected summer day, in that the ranking order seen in figure 6 is repeated in figure 5 with the exception of programs C and H. These are the only two programs represented on figure 6 which modelled each floor as a single zone, and so it should be expected that they would predict lower heating and cooling duties. In the IEA- $\emptyset$  exercise, the reason for the large differences in building storage effects was the program methodology. In the Avonbank exercise, methodology alone probably does not account for the differences in apparent building weight, since all the participating programs used a fairly sophisticated modelling techniques. There are three possible reasons for the divergence in apparent building weight.

- Intermittency of plant operation – the IEA- $\emptyset$  building had continuous plant operation. The intermittency of the Avonbank system will tend to exaggerate any differences in building storage effects.
- The effect of the insulating layer on the storage characteristics of the external walls. In terms of the ASHRAE definition of floor weight, the first floor of the Avonbank building is on the heavy side of medium. Most of this weight is concentrated in the concrete slabs in the floor and wall constructions. However, both these concrete slabs are separated from the internal space by an insulating barrier – the purlboard in the walls, and the carpet on the floor. This means that the internal surfaces of the building will heat up relatively quickly, and so the radiant component of the gains will be realised as a convective load to the space with only a short time lag. The effect of the position of the insulating layer is very evident from some parametric runs reported in reference 4. The relevant graphs are reproduced as figure 7 and show the cooling load profile, i.e. for continuous plant operation. The relative position of the insulation (inside/outside) makes a difference of almost 20% to the peak cooling load. Although the daily totals will be affected less than the h

peak, the intermittancy of the plant will tend to exaggerate the differences. The pre determined room transfer functions as defined in the ASHRAE methodology assumes that the insulating layer is on the outside, and so programmes using this approach (or similar) will tend to underestimate heating and cooling duties. Programs A, E, F and I use this approach, and the results indicate that their results are predicting lower heat extraction rates than the detailed programs (see fig 6). Program D also uses the standard ASHRAE approach, but has reported loads rather than heat extraction rates, hence the difference when compared to other similar programs.

- The proportion of convective/radiant gains from internal heat sources. This is probably only of secondary importance because the dominant internal gain is from the lights which had a defined convective/radiant split, which most of the analysts seem to have used. However some of the other internal gains are also significant (notably people) and the split into convective and radiant portions was left to the discretion of participants. The assumed convective fraction for people ranged from 50 to 100%. This effect can be seen from figure 5 in the dip in heat extraction rate at lunchtime when the occupancy gain reduces to 50% of the maximum. Programmes F and I use similar methodologies but F used a 60% convective portion for people, I used 100%. This is reflected in the fact that curve I shows a big dip, which occurs immediately the people leave the building, whereas F shows a smaller dip lagging I by about 1 hour.

## 7.2 Winter Selected Day

Many of the points raised in the discussion of the summer selected day are also apparent in the winter day. The effect of intermittent plant operation is particularly apparent from these results (fig 4). Fifty percent of the daily heating demand occurs in the first fifteen percent of the system operation. It is clear that it is the start up duty which is critical as far as the heating demand is concerned.

## 8. SYSTEM SIMULATION

The original intention of the Avonbank study was twofold.

- to extend the IEA-Ø work to comparing predicted and actual heat extraction rates for a building.
- To include detailed simulation of the performance of the system in order to predict primary energy inputs to the building.

In the event the work has concentrated almost entirely on the first aspect of the study to the exclusion of the second. There are several reasons for this.

- (i) the relatively poor agreement at the level of heat extraction rate meant that extending the simulation back through the system had little chance of producing meaningful comparisons.
- (ii) the unusual three pipe system used at Avonbank could not be easily modelled by the participants.

However from the little work that has been done on the system, some very interesting points do arise.

### 8.1 Modelling of Fresh Air Fan Coil Unit

The fresh air fan coil unit provides moisture control for the whole building. The unit operates by drawing 100% outside air, and conditioning this air to a constant off-coil condition of 10.5°DB, 10.0°WB. One set of results that analysts were asked to simulate was the simple psychrometric processes involved in this air conditioning process. Fig. 8 shows the results of the analysts for the summer period, and it is evident that there is a significant difference. It seems that the major cause for these differences is different assumptions about the temperature and pressure upon which the specified volumetric fresh air flow was based. This could account for differences of the order of 10% or so, and is sufficient to explain the variation amongst the main group of answers (curves F, I, J and K), but not the consistent overestimate of program G, and the occasionally dramatic overestimate of C. This illustrates the need to very carefully define every aspect of the system controls and performance, if a realistic simulation is to be achieved.



## 8.2 System Simulation

Only two of the participants produced results for the performance of the system, as opposed to the performance of the building. It is therefore very difficult to make any meaningful comments about comparisons between programs, and their ability to model real systems. Figures 9 and 10 show the results of the programs and the measured performance for the summer and winter analysis periods. The only real conclusion that can be made is, that in this particular case, the modelling of the system has tended to blur out the differences at the heat extraction rate level, such that the agreement at plant output level is quite good (of the order of  $\pm 15\%$ ). However, it must be realised that in other buildings and or systems, the separate effects might be additive rather than cancelling.

## 9. SUMMARY AND CONCLUSIONS

The work carried out in simulating the Avonbank building has led to the following conclusions relative to the modelling of real buildings.

- (1) The problem of realistic modelling of heat transport due to air movement through a building due to
  - (a) infiltration
  - (b) convective coupling between zones

The first factor is becoming increasingly important as the conduction heat loss from buildings is reduced by increasing insulation standards. The existence of the IEA Air Infiltration Centre should help in resolving this problem, by providing analysts with better tools for realistically modelling the infiltration process.

The second problem is of particular concern in large open plan areas, particularly where there are different systems to meet the perimeter heat loss and the core cooling demand. In such cases, particular care must be taken in modelling the building so as not to unduly distort the real behaviour of the complex interactions that must exist at the perimeter of a large open plan area.

- (2) As with the IEA-Ø exercise, the modelling of the stored heat within the building fabric has proved to be of importance. The effect of storage is emphasized by intermittancy of the plant which is the situation which is likely to exist in the majority of real buildings. Although all the programmes participating in the Avonbank exercise used fairly detailed models, (pre determined transfer functions being the simplest) the storage effects need to be defined by a parameter more detailed than simple floor weight considerations. For example if a building with massive concrete walls is insulated on the inside, its floor weight may indicate that the structure is heavy, but the building will only provide a relatively short time lag for internally realised radiant gains.
- (3) In certain cases, the modelling of the heat extraction rates from a space cannot be considered in isolation from the equipment provided to meet that requirement. For example, if a space has no latent cooling requirement, in reality latent cooling may still occur, in order to provide the necessary extraction of sensible heat.
- (4) In order to define a building and or system in sufficient detail such that analysts need make no assumptions about input data, an incredible amount of detail has to be provided, which is not realistic in the design situation. Consequently, differences arising from interpretations of the specification are liable to produce significant differences in predicted energy consumption, irrespective of the quality of the computer program. Some time was spent on discussing the type of information needed in building specifications, and these are included as Appendix 2.

## 10. ACKNOWLEDGEMENTS

The work described in this report was carried out under Annex I of the International Energy Agency Implementing Agreement on Energy Conservation in Buildings and Community Systems.

## 11. REFERENCES

1. "Comparison of Load Determination Methodologies for Building Energy Analysis Programmes"  
IEA Report December 1979
2. Cockroft JP & Irving SJ "Avonbank Energy Analysis Project – Building and HVAC Systems Specification"  
December 1978
3. Basnett P Private Communication
4. Lokmanhekim M Winkelmann FC & Buhl W "Thermal Loads Analysis of the Avonbank Building using DOE-2.1"  
LBL Report December 1979

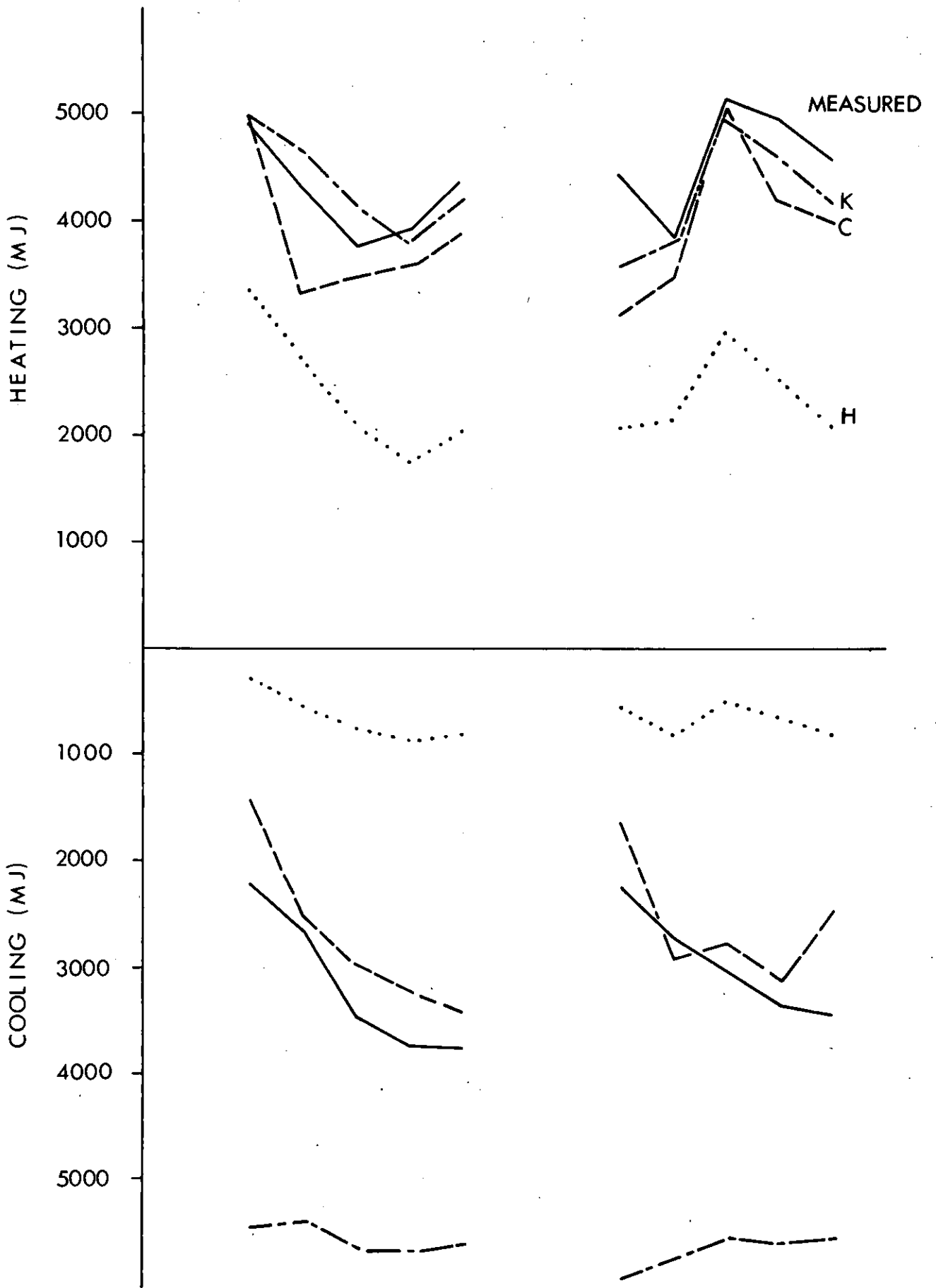

Fig 1 TOTAL BUILDING-WINTER ANALYSIS PERIOD

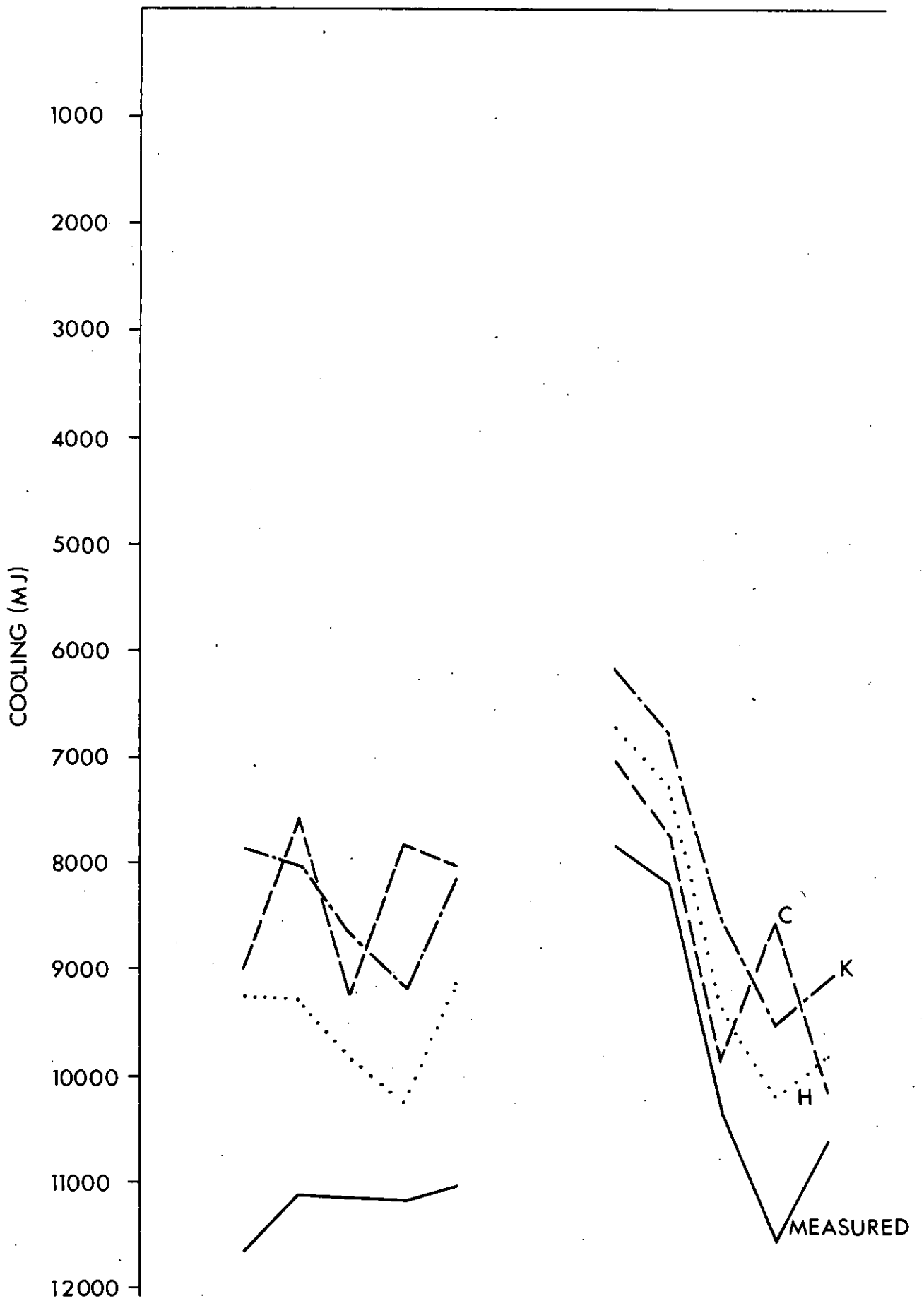

Fig. 2 TOTAL BUILDING-SUMMER ANALYSIS PERIOD

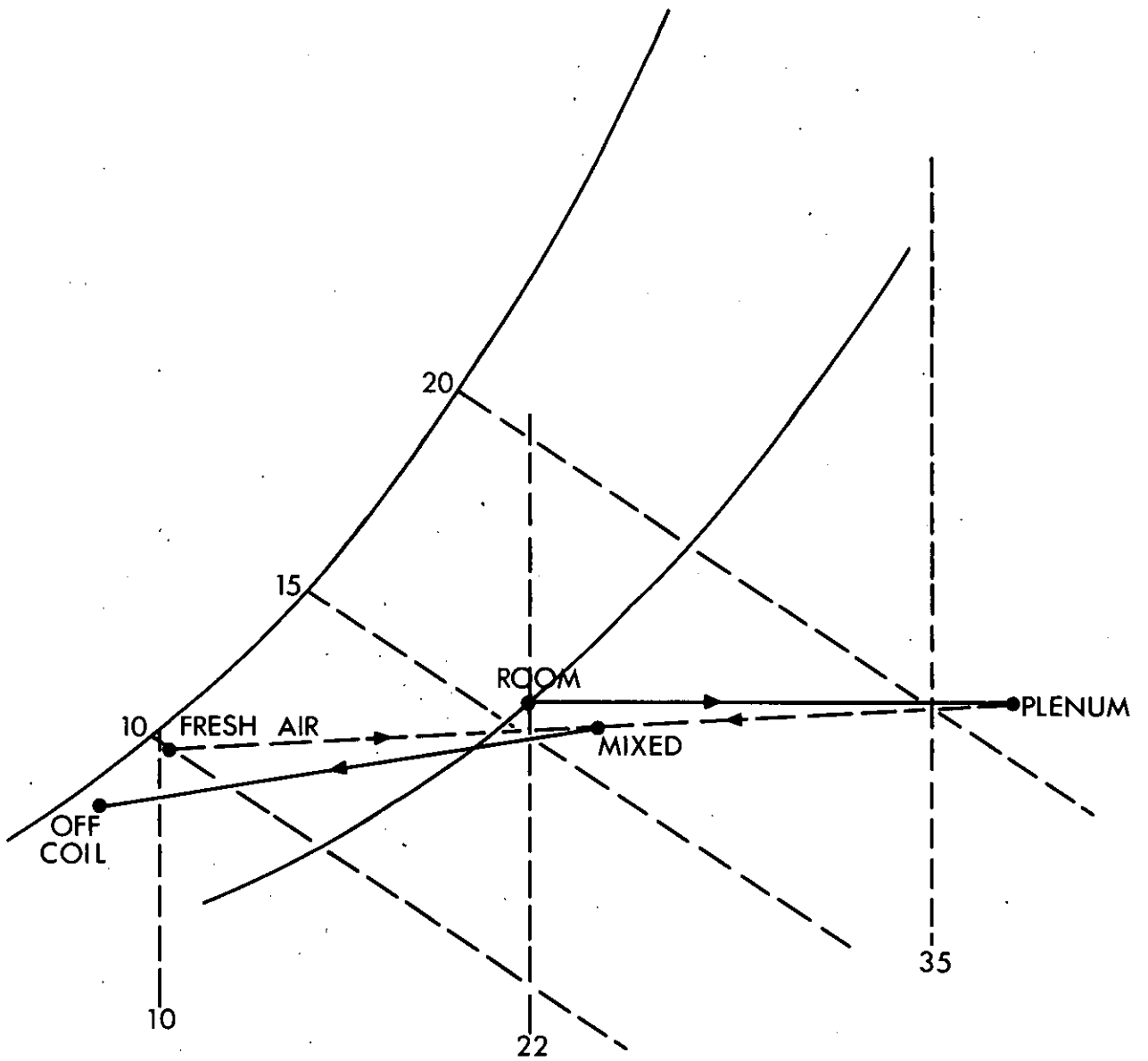

Fig.3 N CORE, FIRST FLOOR  
PSYCHROMETRICS AROUND FAN COIL UNIT



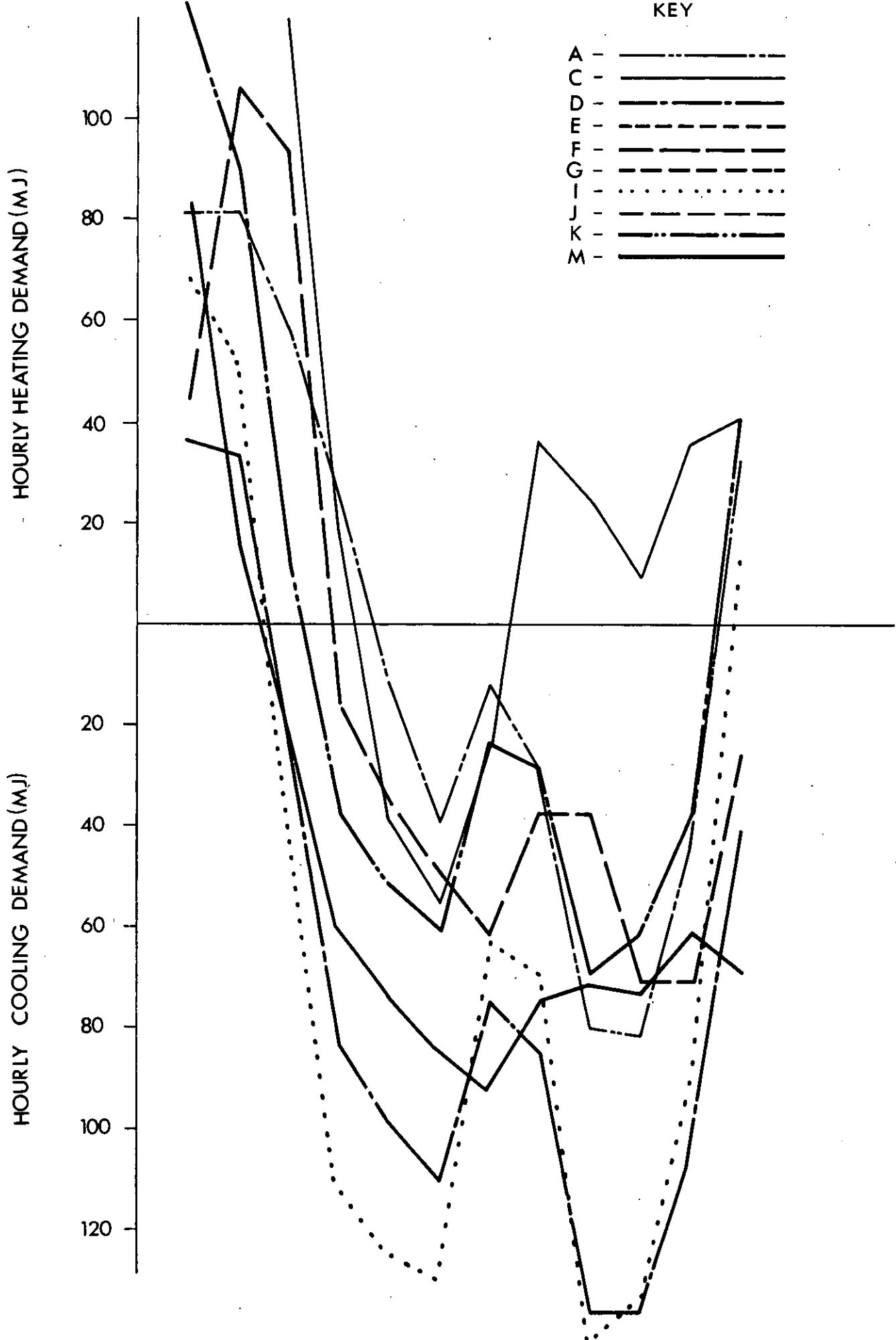

Fig 4

FIRST FLOOR HEAT EXTRACTION RATE  
WINTER SELECTED DAY



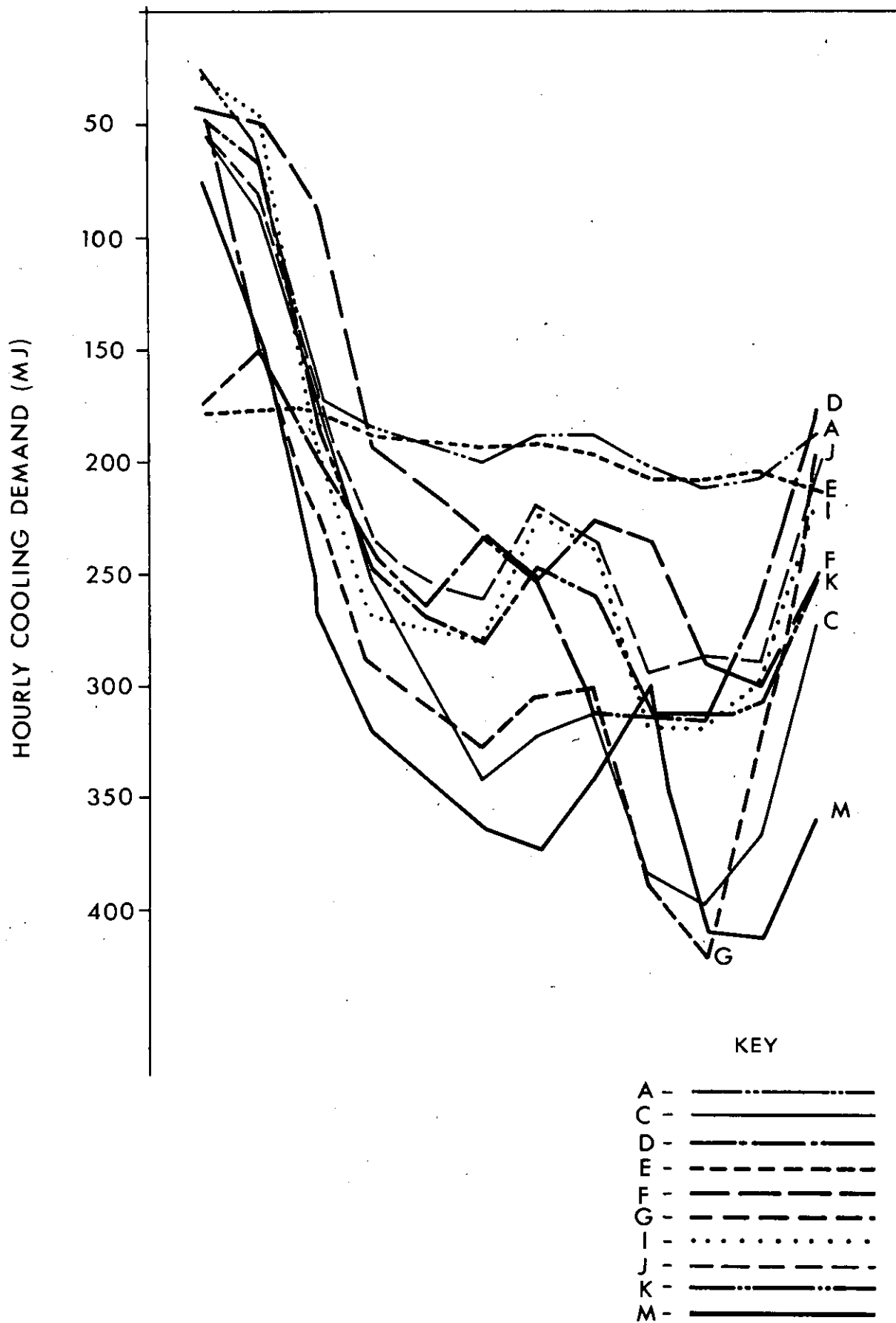

Fig. 5

FIRST FLOOR HEAT EXTRACTION RATE  
SUMMER SELECTED DAY



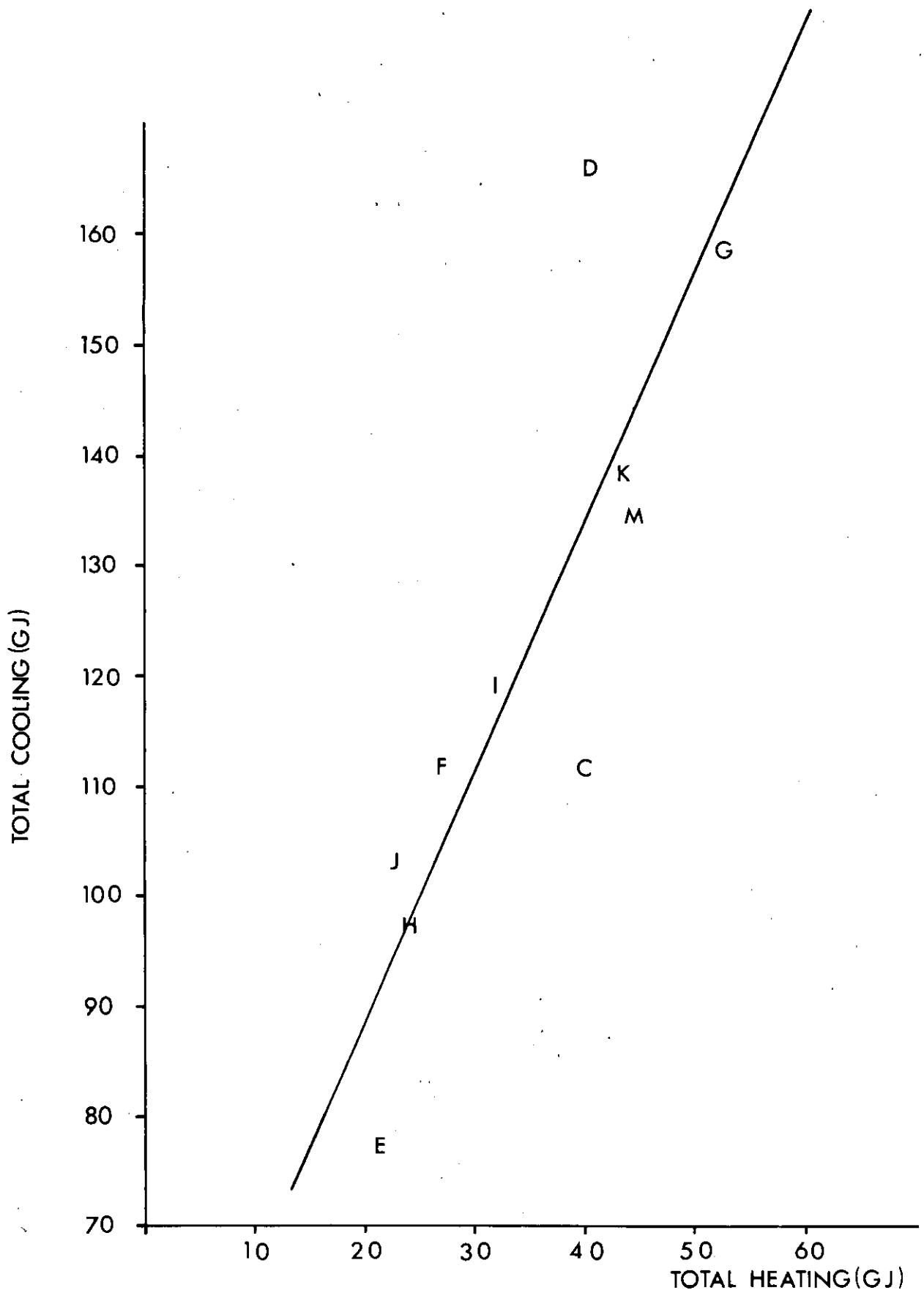

Fig.6 ANNUAL HEATING AND COOLING DEMAND

X



- RUN 1 INSULATION ON THE INSIDE
- RUN 8 INSULATION ON THE OUTSIDE
- ASHRAE PREDICTION, INSULATION ON THE OUTSIDE

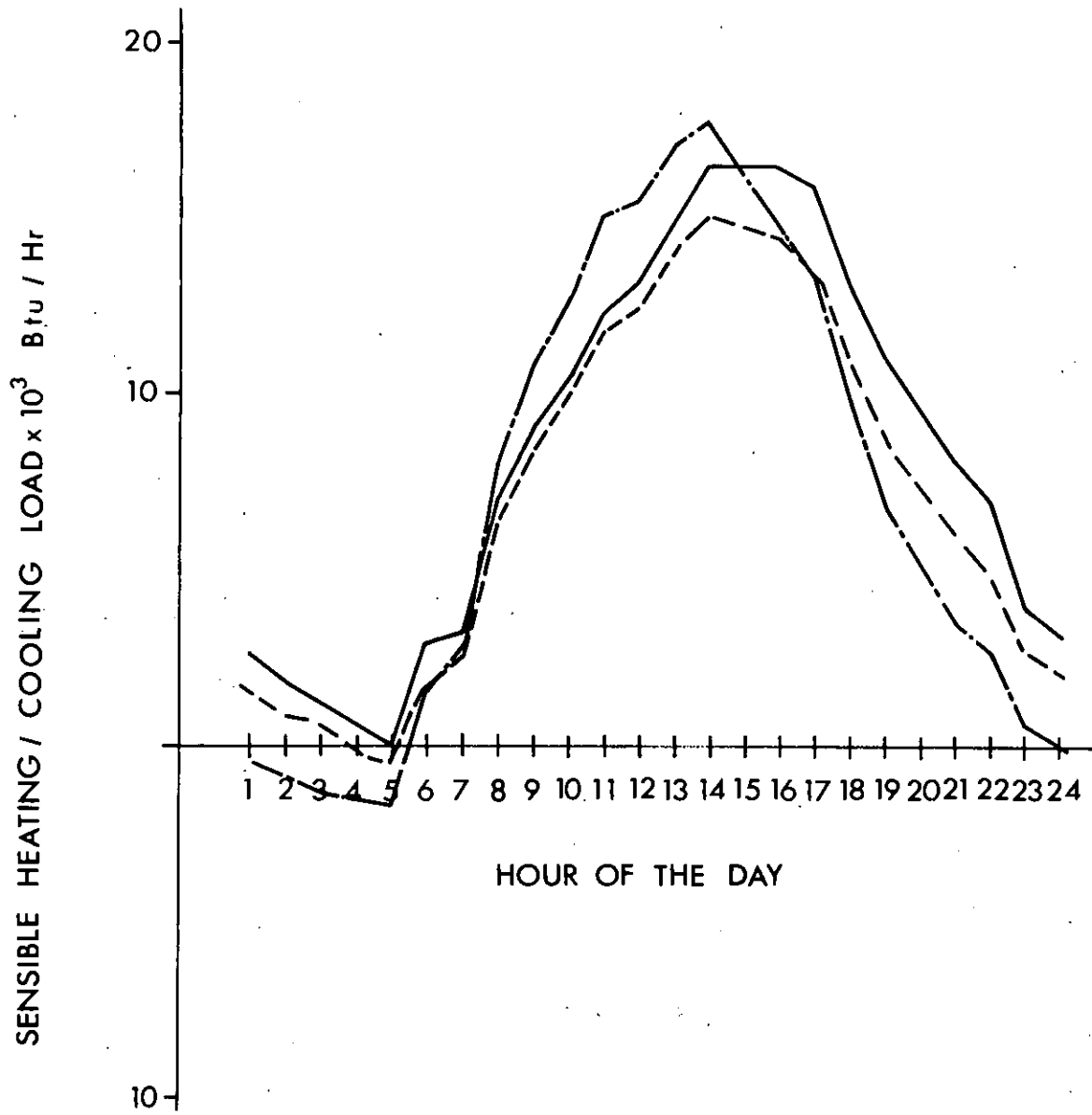

Fig. 7

SECOND FLOOR SOUTH PERIMETER  
COOLING LOAD PROFILE

X

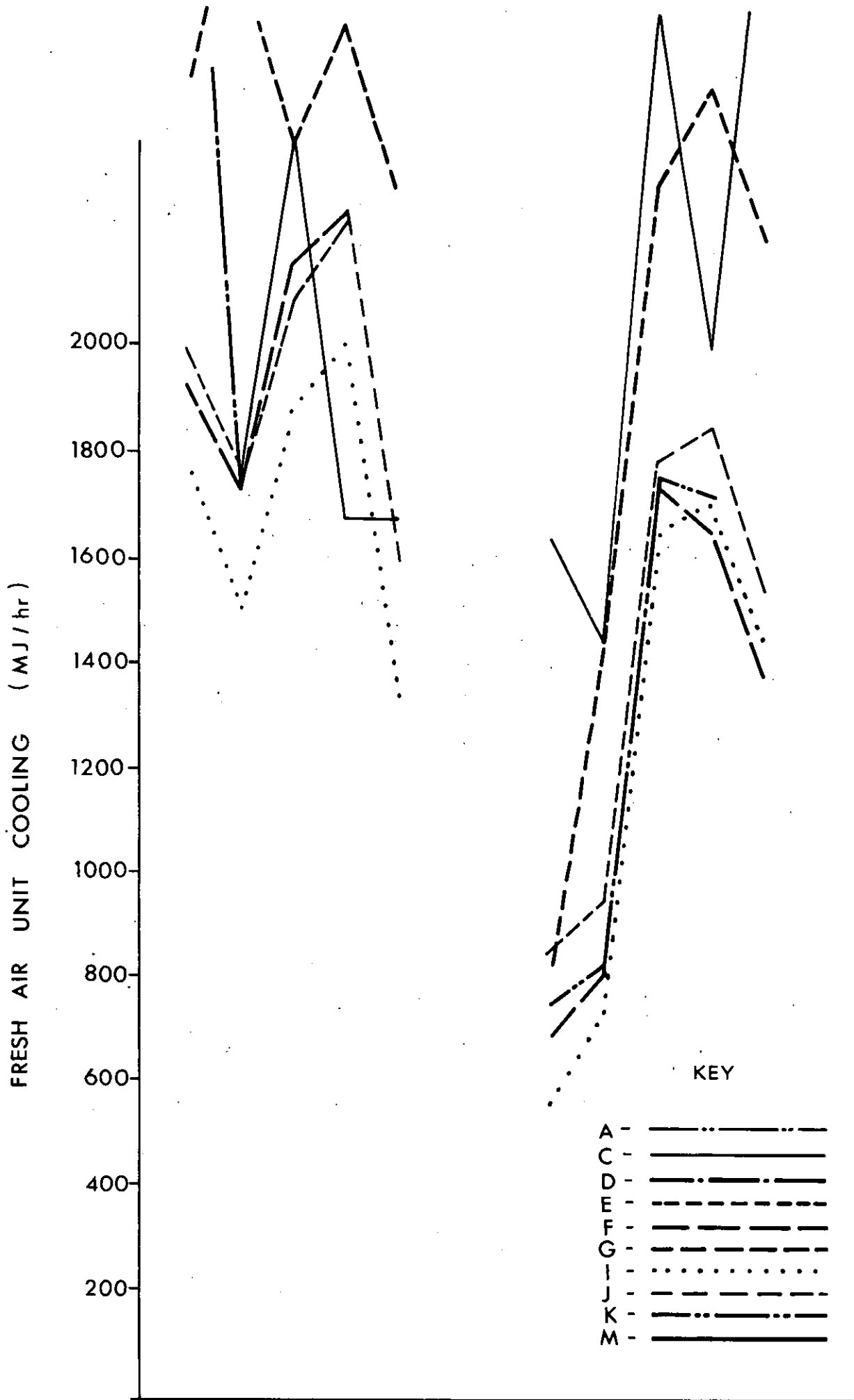

Fig. 8

SUMMER PERIOD  
DAILY COOLING ON FRESH AIR UNIT

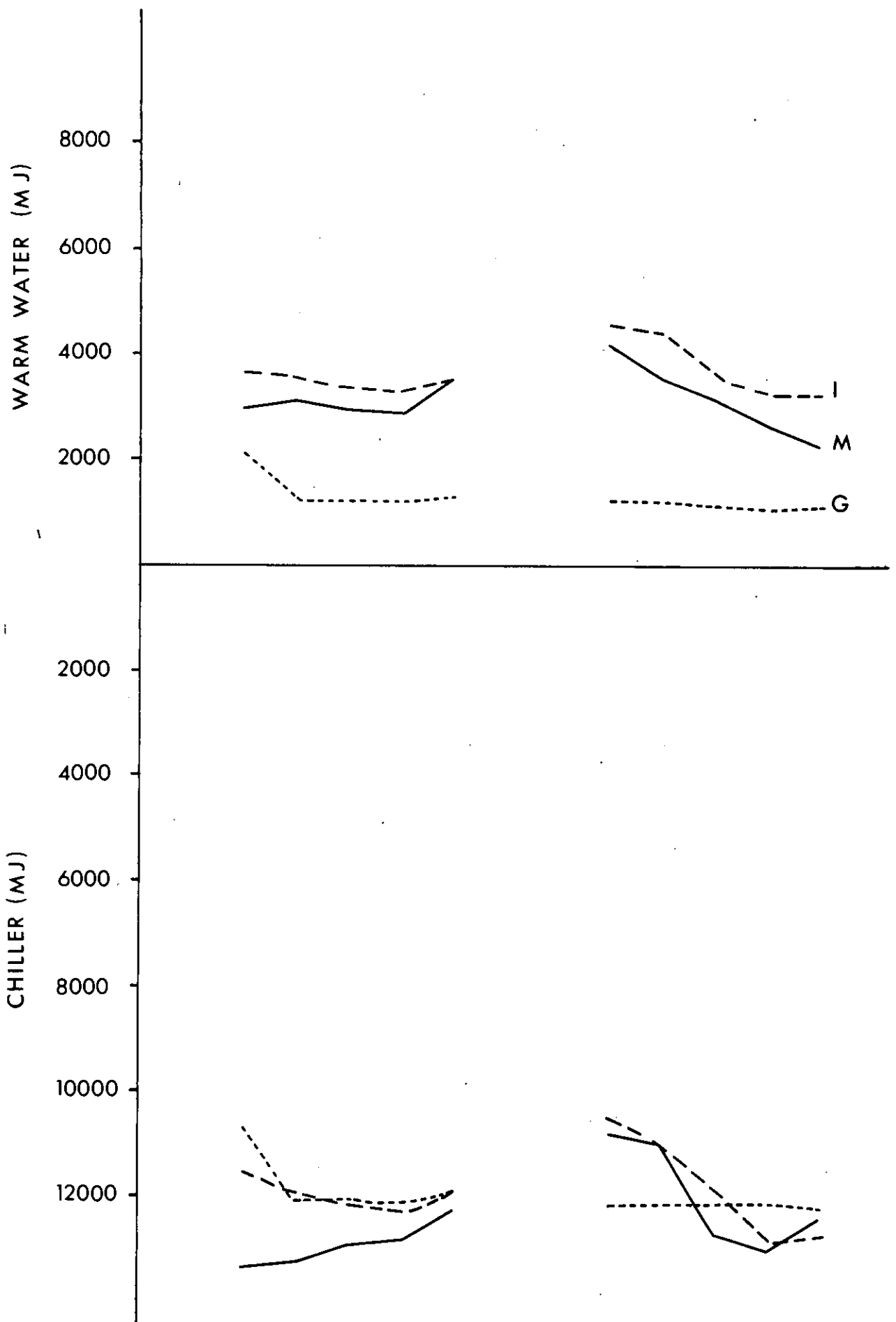

Fig. 9 CHILLER AND WARM WATER OUTPUTS-SUMMER

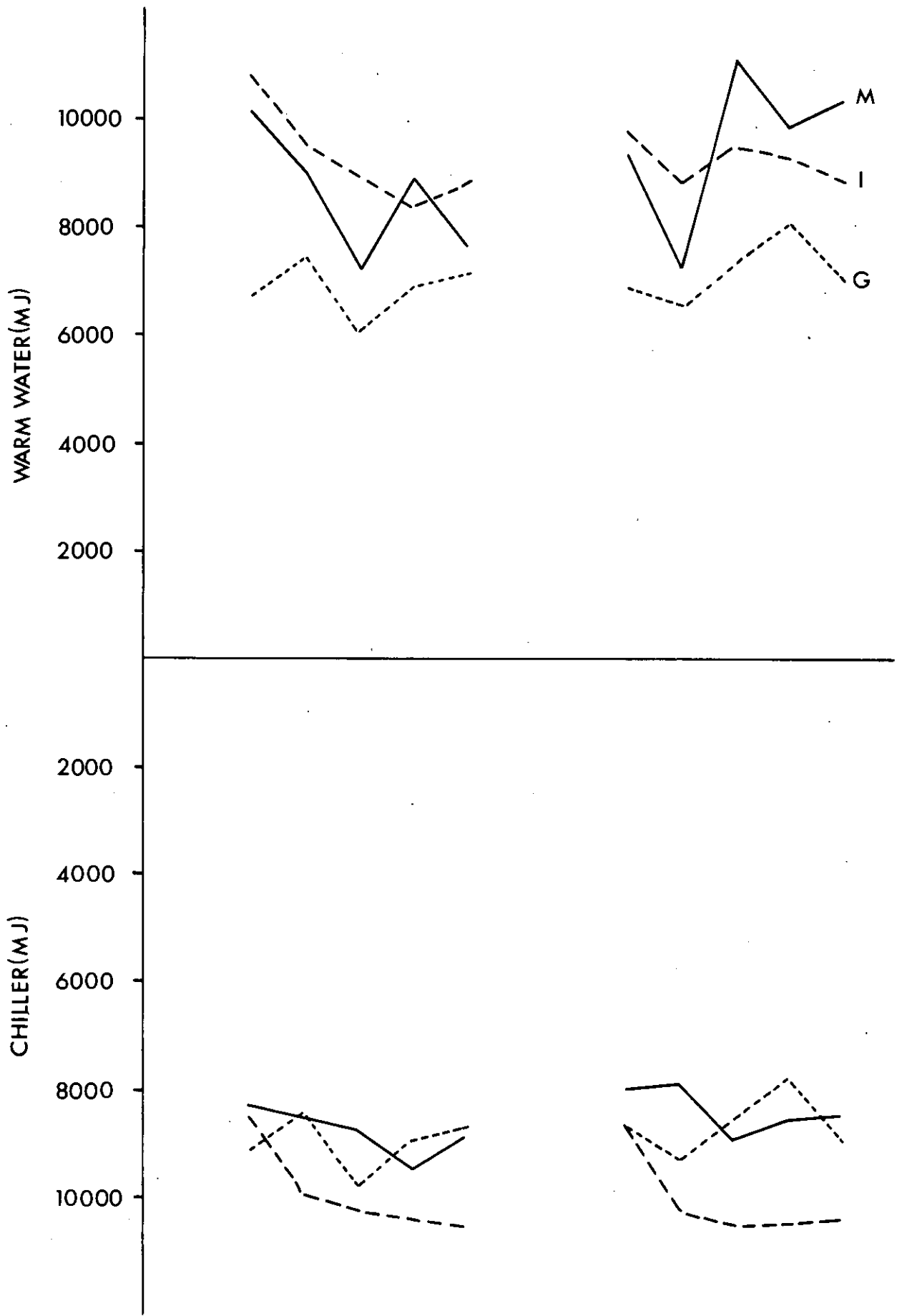

Fig.10

CHILLER AND WARM WATER OUTPUTS-WINTER

**APPENDIX 1**

**Avonbank Architectural and  
Systems Specification**

## 1. INTRODUCTION

The Avonbank building is an all electric air conditioned office building on three floors which has been extensively monitored for a number of years. Although the monitoring equipment is no longer in operation, a considerable quantity of data has been collected by the South West Electricity Board, and this data has been made available to the IEA project. Two two-week periods, one in January and one in July 1973 have been chosen for the detailed analysis of energy consumptions.

This specification is intended to provide sufficient information to enable participants to model the building and the HVAC systems in a realistic way. Specification of internal partitioning has been omitted as its effect on the thermal behaviour of the Avonbank building should be small. Twenty one zones have been specified, and the heating/cooling loads for each of these zones should be calculated.

A weather tape for Avonbank has been prepared for the whole year of 1973. The data has been collected from weather stations within 10 km of Avonbank.

## 2. THE AVONBANK BUILDING

### 2.1 General

The simple rectangular structure was designed as an insitu concrete box, with holes shuttered for the repetitive windows. Where continuous floor to ceiling glazing is used (in the entrance foyer and conference room), it is set back to allow the first floor to oversail and provide a solar shield to these larger window areas. Reconstructed Portland Capstone feature panels are set vertically between the aluminium vision windows for the full height of the building.

The centrally situated service core contains the lift, stairs, toilets, heating and ventilating equipment, and the electrical and telephone ducts. It has a lowered ceiling, allowing ducting and service equipment to be housed in the space above. The ceiling in the office areas consist of air-tight suspended acoustic tiles with ductwork running in the space above, which acts as a common return air plenum. Air conditioning plant are housed in the basement and in the rooftop plant room.

The air-conditioning system has been designed for heat recovery, with water storage vessels in the basement providing back-up storage. Off-peak electrical immersion heaters top-up this heat store overnight, as required.

### 2.2 Location

The building is sited at Feeder Road, Bristol.

Latitude  $51^{\circ} 27' N$

Longitude  $2^{\circ} 34' W$

The longitude of the standard time meridian is  $0^{\circ}$ . (Greenwich Mean Time). The North face of the Avonbank building is oriented  $17^{\circ} W$  of North. Although there are several other buildings in the same locality, there is no direct solar shielding from neighbouring buildings.

### 2.3 Dimensions

Figures 1, 2, 3 and 4 show plans of the basement, ground floor, first floor and roof top respectively. The second floor is identical to the first floor. Figures 5, 6 and 7 show North, South, and East elevations of the building. The main dimensional information is provided on these figures. Figure 8 is a composite vertical cross section through the first floor, second floor and roof top plant room. Above the change of section line, the wall construction above and below windows is shown; below the change of section line, the construction between windows is shown. Figure 9 is a detail of the external facade showing the wall and window dimensions which apply to the majority of the glazing. Figure 10 is detail of the facade of the ground floor. The basement is exposed by a mean value of 0.6 m around its perimeter.

### 2.4 Fabric Construction

Figure 11 gives the details of the fabric construction for the external walls, roof and floors. The exposed external wall of the basement should be taken as being of the under window type construction of figure 11. The thermal properties of the fabric are given in Appendix B.

Glazing consists of Pilkington clear 3 mm float glass formed into sealed units with a 6 mm air gap. For the glazing in the main areas of the facade, the glass is recessed by 410 mm behind the cladding panels of the "between window construction", and is overhung by 330 mm by the "above window construction". The glazing in the conference room area is identical to the main areas of the facade except in the proportion of the external surface it occupies, and the fact that it is not set back in the walls. (However it is overhung by the first floor). The windows on the west wall of the building protected by the solar shield are similar to those in the conference room. The small windows on the North face of the building have a total area of 0.9 m<sup>2</sup> and all glazing has the basic properties as described in Appendix B. The dimensions of the various shading devices on the external walls is given in Figure 2. There are no blinds at the windows.

### 3. HVAC SYSTEMS

#### 3.1 Zones

The building is zoned as shown in Figures 2 and 3. Perimeter zones are 3 metres deep; these narrow perimeter zones reflect the correspondence of zone loads with the operation of the fan coil units. Additionally, because of the small areas of glazing, solar penetration is not expected much beyond the 3 metre zone depth. Tables 1 and 2 give details of each zone including maximum values of lighting loads, occupancy, fresh air supply rates and infiltration. For the purpose of the program comparison, it should be assumed that there is no convective coupling across zone boundaries.

Infiltration will occur in this building due to the action of wind and stack effect, because

- (a) the windows are openable (for cleaning purposes only) and therefore significant cracks will be present
- (b) the building is only slightly pressurised

The building was designed assuming a constant infiltration rate of 0.25 air changes per hour based on the total building volume. It is assumed that all the infiltration load is met by the perimeter zone fan coil units, and so the total infiltration has been proportioned to the various perimeter zones in the ratio of their exposure to the external environment. These zone infiltration rates are given in Table 1. This simplifying assumption is considered valid since this amount of infiltration will only amount to about 5% of the total building load, at the summer design condition, and so there seems little value in constructing a complex model to describe the variations in infiltration.

Although the roof top plant room is not conditioned, it acts as a plenum for the air exhausted via the toilet extracts. Therefore it should be assumed that there is negligible heat losses from the second floor through the area of the roof defined by the plant room.

#### 3.2 Fan Coil Units – General Description

Fan coil units distributed throughout the building provide heating and/or cooling in each of the zones defined previously. Air is drawn through the ventilated light fittings, mixed with fresh air where provided, and supplied via the fan coil units to ceiling mounted slot diffusers. All the circulation air, plus the fresh air is returned to the space, the excess air being drawn off by extract fans in the toilets. Thus all the lighting gain is eventually seen as a load in the space. This is shown schematically in Figure 12. A three pipe system is employed, using a single heat transfer coil in each fan coil unit. To reduce mixing losses, some units are provided with chilled water only. These units are mainly in the core regions where there is no heating requirement. These units are identified in Table 2.

Fresh air is supplied to certain fan coil units as specified in Table 2. The fresh air plant in the roof top plant room consists of a pre-heater/cooler heat exchanger with a 3 way valve and a recirculating pump type spray humidifier which provides humidity control for the whole building. The heat supply to the fresh air unit is not taken off the heating main, but draws from the warm water return on the secondary heating circuit. The fresh air is supplied to the zone fan coil units at a constant 10.5°C DB, 10.0°C WB.

The heating-cooling fan coil units are controlled on a constant flow variable temperature basis, the temperature of the inlet to the coil being controlled by the mixing at the three way valve. The cooling only units are controlled on a variable flow constant temperature basis.

However the total flow of chilled water is kept constant, but a variable proportion of it is bypassed around the coil, (Fig 12) the proportion being controlled by the demand of the unit.

### 3.3 Hydraulic Systems – General Description

Figure 13 illustrates the hydraulic circuits for the air-conditioning system. The cool water circuit serves the fresh air unit, cooling only fan coil units, and cooling/heating (3 pipe) fan coil units. Two rooftop chillers are connected to this circuit, one of which is a "double bundle" machine with a closed condenser for heat recovery. When the capacity of the closed condenser is exceeded, heat is rejected to the roof-top cooling tower through the open condensers.

The heating circuit serves those fan-coil units with cooling/heating duties. Two hot water storage tanks in the basement provide back-up heat when the heat recovery is insufficient to meet heating demand. Off-peak immersion heaters top up this heat store overnight. Figure 14 is a simplified schematic showing the principal energy flows in the primary and secondary plant system. A supply is taken off the heating primary circuit to feed the canteen which is housed in a separate building.

### 3.4 Primary Chilled Water Circuit

Two chillers, Nos 1 and 2, have their evaporators in series in the primary loop. The outlet water temperature is controlled, with No 2 chiller leading, at 6.2°C. No 1 chiller is a standard chiller with normal condenser, No 2 machine has a split condenser, one section being the open side for heat rejection to the cooling tower, and the other side being the closed circuit side for heat recovery. Figure 15 gives the characteristics of these chillers. Machine 2 has a capacity of 185kW. Machine 1 has a capacity of 207kW. It is assumed that No 1 machine operates only when No 2 machine is on full load. The flow through the open condensers is in series counter flow to the evaporator flows. The condensers water inlet temperature T8 is allowed to rise to 24°C before condenser water is by-passed using valve V6 through the cooling tower. The cooling tower fan operates if the temperature T8 continues to rise on full by-pass.

The closed side of the split condenser on No 2 chiller is connected to the primary heating circuit which can absorb the total heat reject from No 2 machine. When the condenser heat rejected exceeds the heating demands (see 3.5), cooling tower water is progressively diverted through the open side of the split condenser using valve V4. Water flow rates in the primary circuit and condenser circuit are shown on figure 13.

### 3.5 Primary Heating Water Circuit

The proportion of water flowing through the open side of the condenser on No 2 chiller is controlled to obtain an outlet temperature from the heating condenser of 35°C maximum. Thermostat T2 controls the minimum warm water temperature between 35°C at -1°C external down to 27°C at 13°C external. This control schedule is illustrated on Figure 16. If the output from the closed condenser is insufficient to meet this control condition, valve V2 is modulated to add heat to the system from the warm/hot tank, provided that the warm/hot tank temperature is above the closed condenser outlet temperature. If the warm/hot tank is cooler than the condenser outlet temperature, the warm/hot tank continues to be by-passed, and heat is added from the hot tank, control being transferred to thermostat T3 and valve V3. Table 3 describes each of the two tanks. They are constructed from mild steel and are insulated by a 90 mm layer of glass fibre.

The stored water is also drawn during periods when the chillers are off, ie for evening heating (canteen).

If the heating demand is being met fully by the closed condenser, at its maximum outlet temperature of 35°C, heat is transferred to the warm/hot tank, provided that the tank temperature is below 35°C.

The off-peak heaters in the warm/hot tank only operate when the external temperature is below 5°C. The tank is heated to 116°C at or below -1°C external, reducing to off (35°C) at 5°C external temperature. The off-peak heaters in the hot tank raise the temperature to 116°C at -1°C external temperature reducing to off (23°C) at 20°C external temperature. These control schedules are illustrated in Figure 16.



Off peak heating is available from 23.00 to 07.00 hours only. Each tank has several immersion heaters which are controlled such as to bring the tank temperature to the control point at the end of the heating period. The heat input to the tanks is assumed to be a function of the difference between the tank temperature and the control point defined by schedules in Figure 17. The thermostat operation of the control of the tank temperatures may be ignored, ie heat is continually added to the tank at a rate defined by Figure 17 until the control temperature is reached, at which point the heaters switch off. Off peak heating to the tanks is switched off altogether during the months of May to August inclusive. The characteristics of the tanks are given in Table 3.

The water flows in the primary heating circuit are shown in Figure 13. A supply is taken directly off this circuit to supply the heating demand of the canteen which is housed in a separate building. The demand of the canteen block is shown by the profiles of Figure 18.

### 3.6 Secondary Chilled Water Circuit

The secondary chilled water is maintained at a constant 6.5°C by sensor T<sub>7</sub> operating a valve V<sub>5</sub> (Fig 13) to control the flow and return from the primary chilled water circuit. The flow rates are indicated on Figure 13.

### 3.7 Secondary Heating Warm Circuit

The secondary warm water temperature is controlled by thermostat T1 (Fig 13) which modulates valve V1. The outside temperature compensator varies the thermostat set point according to the schedule shown in Figure 16. The flowrates are indicated on Fig. 13.

### 3.8 Plant Energy Inputs

The following data applies to the main energy consuming items of plant not described elsewhere in the specification.

Primary chilled water pump (roof)	1.9 kw
Condenser water pump (roof)	5.6 kw
Primary heating water pump (roof)	3.1 kw
Cooling tower fan	3.3 kw
Transformer (basement)	10.0 kw
Secondary chilled water pump (roof)	1.04 kw
Secondary heating water pump (roof)	1.04 kw

### 3.9 Thermal Capacity of the Hydraulic Systems

In order to accurately simulate the HVAC systems, account should be taken of energy stored in the thermal capacity of the system. The appropriate values are given in Table 4.

## 4. OPERATING SCHEDULES

### 4.1 Occupancy

The maximum occupancy of each zone as detailed in Table 1 is subject to a weekday profile as given in Figure 19. There is no occupancy at weekends. The sensible and latent heat gains due to occupancy are given in Appendix B.

### 4.2 Lighting and Small Power

The maximum lighting load specified in Table 1 is subject to an hourly profile which differs from zone to zone and from day to day. The correct profile for each zone is identified by Table 5 and Figure 20. These lighting profiles are based on readings of electricity consumption meters on the North and South sides of each floor. For the east and west perimeter zones the lighting profiles should be taken as the arithmetic mean of the profiles for the North and South on the appropriate floor.

Figure 21 illustrates the design of the ventilated light fittings. The split of the lighting load into convective and radiant fractions both upward and downward is given in Appendix B. Because all the air drawn through the fitting is returned to the space, all the lighting gain is eventually seen as a load in the space. The maximum gain due to small power given in Table 1 is assumed to follow the same hourly profile as the occupancy.

### 4.3 Plant

The plant operates from 6.00 to 18.00, five days a week throughout the year, to maintain the following dry bulb temperatures.

Ground floor	22.0°C
First floor	21.7°C
Second floor	22.0°C

The fresh air fan coil unit maintains the fresh air supply condition very close to saturation, which when delivered to the zones, is intended to maintain a condition of 50% R.H. during the operating hours.

The thermostat controls allow the temperature to drift around the set points by up to 0.5°C depending on the heating/cooling load, but there is insufficient data to enable separate thermostat characteristics to be specified for every zone. In view of the very small deviations from the set points, it is recommended that the above temperatures be assumed constant during the occupied periods with the zone loads limited by the design loads set out in Table 2, or by whatever loads are calculated as a result of modelling the primary and secondary HVAC systems.

The absorbed fan power of the zone fan coil units will be distributed to the zones during the operating hours.

### 4.4 Fresh Air Fan

During the winter months the fan in the fresh air fan coil unit operates to the same schedule as the plant, but during the summer months (May to August), the fan operates 7 days a week, from 6.00 to 23.00. Therefore, unconditioned outside air is delivered to the zones defined in Table 2 after the main plant has shut down, and at weekends.

### 4.5 Time Shifts

The times given in the plant schedules refer to clock time. During the summer months the U.K. adopts a daylight saving scheme whereby the clocks are put forward one hour; this is known as British Summer Time (BST). During the winter months the time is based on Greenwich Mean Time (GMT) which is solar time at the Greenwich Meridian (0° longitude). Thus 14.00 hours BST is equivalent to 13.00 hours GMT. The winter schedules are given in GMT, the summer schedules in BST. It should be noted that the weather tape is given in terms of GMT throughout the year.

## 5. WEATHER DATA

Weather Data for Avonbank for the entire year of 1973 has been prepared and recorded on magnetic tape. The tape is a combination of weather data measured at two separate sites about 10 km from Avonbank. The data is encoded as card images, one 80 character card per hourly record. The format of the cards is as follows:

Field	Columns	Item	Units
—	1-5	blank	
1	6-8	dry bulb temperature	0.1°C
2	9-11	wet bulb temperature	0.1°C
3	12-14	dew point temperature	0.1°C
4	15-17	wind direction	degrees from N
5	18-20	wind speed	knots
6	21-25	*mean sea level pressure	0.1 mb
7	26-27	cloud cover	tenths
	28-51	blank	
8	52-55	total solar radiation on horizontal	W/m <sup>2</sup>
9	56-59	direct normal radiation	W/m <sup>2</sup>
10	60-63	diffuse radiation on horizontal	W/m <sup>2</sup>
11	64-66	solar altitude	degrees
12	67-69	solar azimuth	degrees from N
13	70-73	Year	
14	74-75	Month Number (1-12)	
15	76-77	day of month	
16	78-79	hour of day	

- The mean sea level pressures are available for the synoptic hours only (ie 0.00, 3.00, 6.00, 9.00, 12.00, 15.00, 18.00, 21.00). Intermediate values are written out as zeros.
- † The hour value on the tape represents the starting time GMT for the hour associated with that hours data.

The solar radiation on the horizontal surface was measured at Long Ashton. This data was then split into direct radiation falling on a surface normal to the suns rays, and diffuse radiation on a horizontal surface. All the information on the tape, other than the solar radiation and solar position data, was obtained from a Meteorological Office weather station at Filton.

## 6. COMPUTER RUNS

Comparison of computed and measured building thermal performance will only be carried out for the following analysis period of 1973.

Winter	January 6 to 19 inclusive
Summer	July 14 to 27 inclusive

Computer programmes should be run for a minimum of five days before the start of each analysis period, ie. the minimum run will be for  $5 + 14 = 19$  days.

The following five sets of loads should be calculated.

1. Zone Loads This should include
  - (a) transmission
  - (b) infiltration
  - (c) lights
  - (d) people
  - (e) small power
  - (f) fresh air from outside conditions to room conditions, including the latent load
  - (g) fan coil unit absorbed fan power
2. Zone fan coil unit load. This should include
  - (a) transmission
  - (b) infiltration
  - (c) lights
  - (d) people
  - (e) small power
  - (f) fresh air from supply conditions of 10.5°C DB 10.0°C WB to room conditions
  - (g) fan coil unit absorbed power
3. Fresh air fan coil unit load. This should include the sensible and latent loads in bringing the fresh air from outside conditions to 10.5°C DB, 10.0°C WB. The absorbed fan power should also be accounted for.
4. Chiller and warm water outputs, ie. the transfer from the primary to the secondary circuits.
5. Chiller input, and hot and warm/hot tank inputs, ie. the primary energy supplies.

These values should be reported by zone, by floor and for the whole building for each day of the analysis periods, and each hour of the selected days.

**TABLE 1 DETAILS OF ZONES**

	ZONE	FLOOR AREA m <sup>2</sup>	EXTERNAL PERIMETER m	LIGHTING LOADS (PEAK) kW	SMALL POWER (PEAK) kW	OCCUPANCY PERSONS (PEAK)	INFILTRATION m <sup>3</sup> /s
GROUND FLOOR	Basement	580	94.7 (to ground)	13.5	0	0	.15
	Private Offices	149	23.4W, 9.2N, 5.5E	4.3	0.2	4	.08
	Public Foyer	266	9.1N	18.3	0.2	4	.02
	Conference/ Entrances	189	6.6N, 27.6E, 2.6W	14.5	0	0	.08
	South Core	554	2.1N, 3.2E	31.4	3.9	62	.01
	South Perimeter	77	27.9S	2.8	0.4	7	.06
	South-East Perimeter	62	21.8E	2.3	0.3	5	.05
	South-West Perimeter	95	32.9W	3.5	0.5	8	.07
		1392	171.9	77.1	5.5	90	.37
	FIRST FLOOR	North Core	536	-	17.0	4.4	72
South Core		536	-	22.4	6.0	97	0
North Perimeter		74	27.4N	1.4	0.3	5	.07
South Perimeter		74	27.4S	1.9	0.7	11	.07
East Perimeter		159	56.0E	3.5	1.5	24	.14
West Perimeter		159	56.0W	3.5	1.2	20	.14
		1538	166.8	49.7	14.1	229	.42
SECOND FLOOR	North Core	536	-	37.5	1.4	23	0
	South Core	536	-	29.7	2.1	34	0
	North Perimeter	74	27.4N	3.2	0	0	.07
	South Perimeter	74	27.4S	2.5	0.2	3	.07
	East Perimeter	159	56.0E	6.0	0.1	2	.14
	West Perimeter	159	56.0W	6.0	0.6	9	.14
		1538	166.8	84.9	4.4	71	.42
	Roof Plant Room	244	12.3N, 12.3S 22.0E, 22.0W	0	0	0	.06
		5292		225.2	24.0	390	1.27

**TABLE 2 DETAILS OF HVAC SYSTEMS**

	ZONE	TOTAL AIR CIRCULATION m <sup>3</sup> /s	FRESH AIR SUPPLY m <sup>3</sup> /s	FAN POWER kW	DESIGN HEATING LOAD kW	DESIGN COOLING LOAD kW	WATER FLOW RATE kg/s	FAN COIL UNITS – REMARKS
GROUND FLOOR	Basement	.86	0	1.6	5.5	8.3	.2	
	Private Offices	1.29	0.15	2.1	10.3	15.6	.4	Cool only
	Public Foyer	.53	0.10	0.6	-	4.6	.1	
	Conference/ Entrances	3.83	0.20	3.7	37.8	57.3	1.3	Cool only
	South Core	1.45	0.50	1.5	-	22.4	.5	
	South Perimeter	0.43	0	0.8	3.7	5.6	.1	
	South-East Perimeter	0.53	0	0.8	4.5	6.8	.2	
	South-West Perimeter	0.63	0	0.8	5.9	9.0	.2	
			0.95	10.3	62.2	121.3	2.8	
	FIRST FLOOR	North Core	1.44	0.7	1.5	-	17.0	.4
South Core		1.44	0.7	1.5	-	17.0	.4	
North Perimeter		0.14	0	.6	1.5	2.2	.1	Cool only
South Perimeter		0.43	0	.8	3.2	4.9	.1	
East Perimeter		1.32	0	1.5	9.5	14.4	.3	
West Perimeter		1.06	0	1.1	8.4	12.7	.3	
			1.4	7.0	22.6	68.2	1.6	
SECOND FLOOR	North Core	2.12	0.6	3.0	18.6	28.2	.6	
	South Core	2.12	0.6	3.0	18.6	28.2	.6	
	North Perimeter	0.27	0	0.6	2.5	3.7	.1	
	South Perimeter	0.41	0	0.8	3.5	5.4	.1	
	East Perimeter	1.37	0	1.1	10.5	16.0	.4	
	West Perimeter	1.18	0	1.5	9.9	15.1	.3	
			1.2	10.0	63.6	96.6	2.1	
Fresh Air Plant		3.55	5.1	49.7	114.0	2.5		
			34.0	203.6	408.4	9.2		

**TABLE 3 THERMAL STORAGE TANK DATA**

TANK	DIAMETER m	LENGTH m	CAPACITY kg	IMMERSION HEATERS kW
Warm/hot	2.13	5.7	18,500	360
Hot	1.83	5.6	13,600	180

Insulation of tanks consists of a 90 mm layer of rigid glass wool slabs.

**TABLE 4 CAPACITY OF CHILLED AND WARM WATER CIRCUITS**

Pipe Insulation consists of wired-on polystyrene sections.

	Pipe Diameter mm	Pipe Length m	Insulation Thickness mm
Primary Heating Circuit			
Pipework	75	75	25
Heat recovery condenser	19	300	-
Canteen flow and return	50	71	25
Primary Cooling Circuit			
Pipework	75	15	38
Chiller No. 1 evaporator	19	250	-
Chiller No. 2 evaporator	19	250	-
Cooling Tower Circuit			
Pipework	75	28	38
Chiller No. 1 condenser	19	300	-
Chiller No. 2 open condenser	19	300	-
Secondary Cooling Flow			
Pipework to zone fan coil	50	23	25
Units	25	120	25
Pipework to fresh air fan coil unit	25	19	25
Secondary Heating Flow			
Pipework	50	24	25
	25	280	25
Secondary Returns			
Pipework from cooling – only	50	31	25
Fan coil units	25	80	25
Pipework to and from fresh air fan coil unit	25	18	25
Pipework from other fan coil	50	26	25
Units	25	280	25
Cooling Tower – Water content 1000kg Total mass 2000kg			

**TABLE 5 LIGHTING PROFILES**

Period	Ground Floor and Basement	First Floor		Second Floor	
		North	South	North	South
Winter	A	E	H	M	Q
Summer	D	G	H	P	S

## **APPENDIX B**

Thermal and Heat Transfer properties of Materials and Components.

This appendix tabulates various thermal and heat transfer properties of the building fabric. Only those parameters which are known with some certainty have been included, and such items as film transfer coefficients have been left to the discretion of the participants.

Details of internal heat gains are also supplied.

**TABLE B1 THERMAL PROPERTIES OF BUILDING FABRIC  
(SEE FIGURE 11)**

	THICKNESS mm	CONDUCTIVITY W/m°C	DENSITY kg/m <sup>3</sup>	SPECIFIC HEAT J/kg°C	THERMAL RESISTANCE m <sup>2</sup> °C/W	REMARKS
<b>EXTERNAL WALLS</b>						
Vinyl fabric	2	0.16	1350	1040	0.0125	
Plasterboard	10	0.17	900	840	0.0588	
Purlboard	19	0.023	32	1600	0.8261	
Cavity	3			1000	0.0900	
Concrete	203	1.15	2100	840	0.1765	
Facing	1	2.00	2500	880	0.0005	
Cavity	152			1000	0.1800	
Cladding Panel	76	0.72	1650	840	0.1056	
<b>PLANTROOM WALLS</b>						
Facing	1	2.3	2600	838	0.0004	
Render	13	0.28	750	840	0.0464	
Blockwork	102	0.45	1400	1000	0.2267	
Cavity	89			1000	0.1800	
Polystyrene	25	0.17	1050	1250	0.1471	
Cladding Panel	35			896	0.6200	
<b>ROOF</b>						
Chippings	10	0.43	1600	908	0.0233	
Asphalte	19	1.15	2325	921	0.0165	
Felt	2	0.19	1000	1000	0.0105	
Fibreglass	25	0.042	145	963	0.5952	
Concrete	76	1.15	2100	840	0.0661	
Woodwool	25	0.04	40	1000	0.625	
<b>INTERNAL FLOORS</b>						
Carpet Tiles	5	0.065	270	1600	0.0769	
Screed	51	0.30	1400	840	0.1700	
Concrete	76	1.15	2100	840	0.0661	
Woodwool	25	0.04	40	1000	0.625	
Cavity	838			1000	0.16	
Ceiling	5	0.17	1050	1380	0.0294	
<b>BASEMENT FLOOR</b>						
Solid Concrete		U-value 0.21				



### TABLE B2 SURFACE HEAT TRANSFER PROPERTIES

The radiation exchange between surfaces is characterised by the surface absorptance and emissivity.

The absorptance should be taken as 0.5 for all surfaces, except the green marble of the under window construction which has an absorptance of 0.8.

The emissivity of all surfaces should be taken as 0.9.

### TABLE B3 GLASS PROPERTIES

The characteristics of a single sheet of glass at normal incidence are

Transmitted	0.85
Reflected	0.07
Absorbed	0.08

The thermal resistance of the air gap is  $0.110 \text{ m}^2 \text{ }^\circ\text{C/W}$

The thermal resistance of each sheet of glass is  $0.0029 \text{ m}^2 \text{ }^\circ\text{C/W}$

### TABLE B4 HEAT GAINS

Occupants Gains/Person	Sensible 95 W    Latent 45W
Lighting Percent of Total	Radiation    20% downward    15% upward Convection    5% downward    60% upward

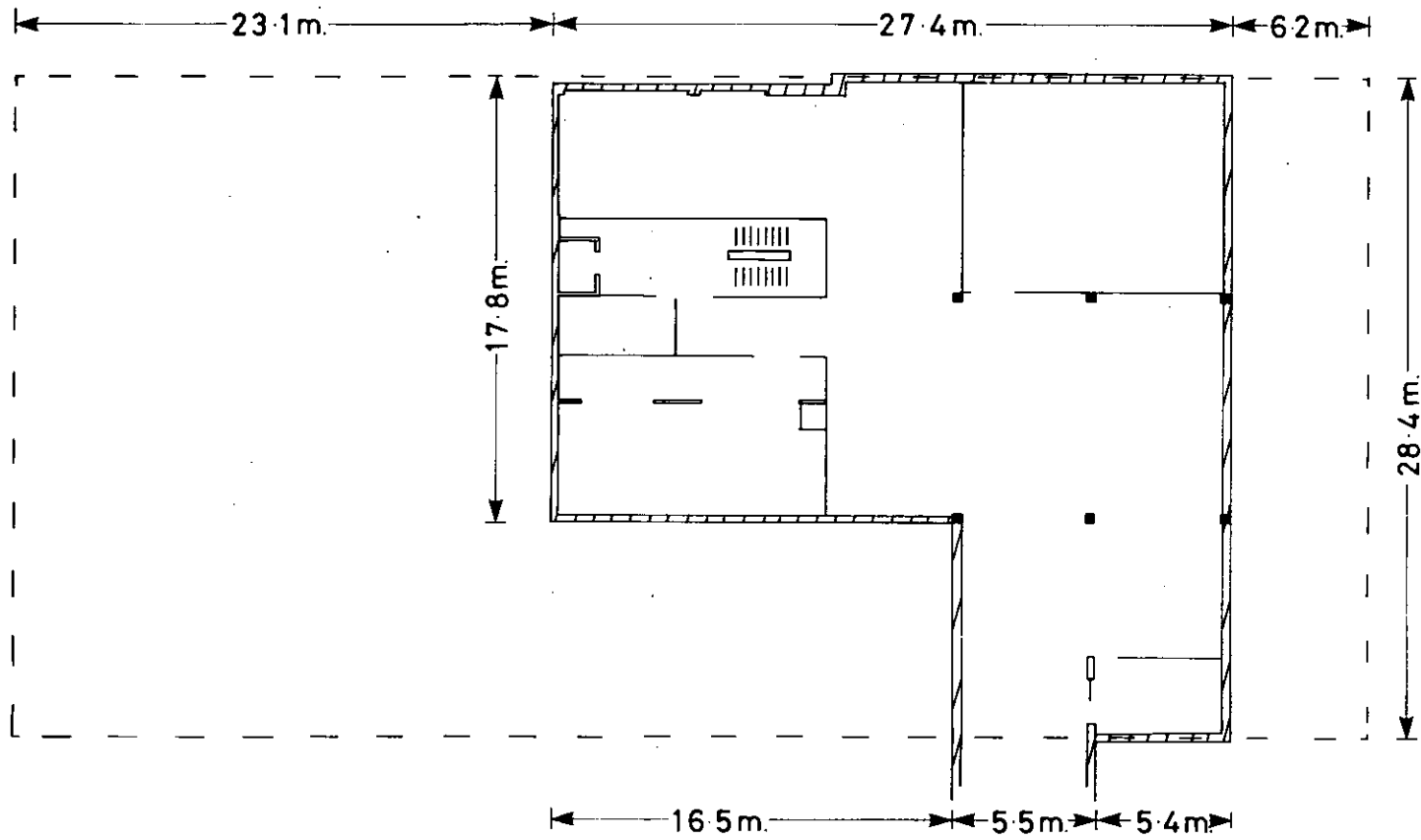

FIGURE 1: BASEMENT PLAN

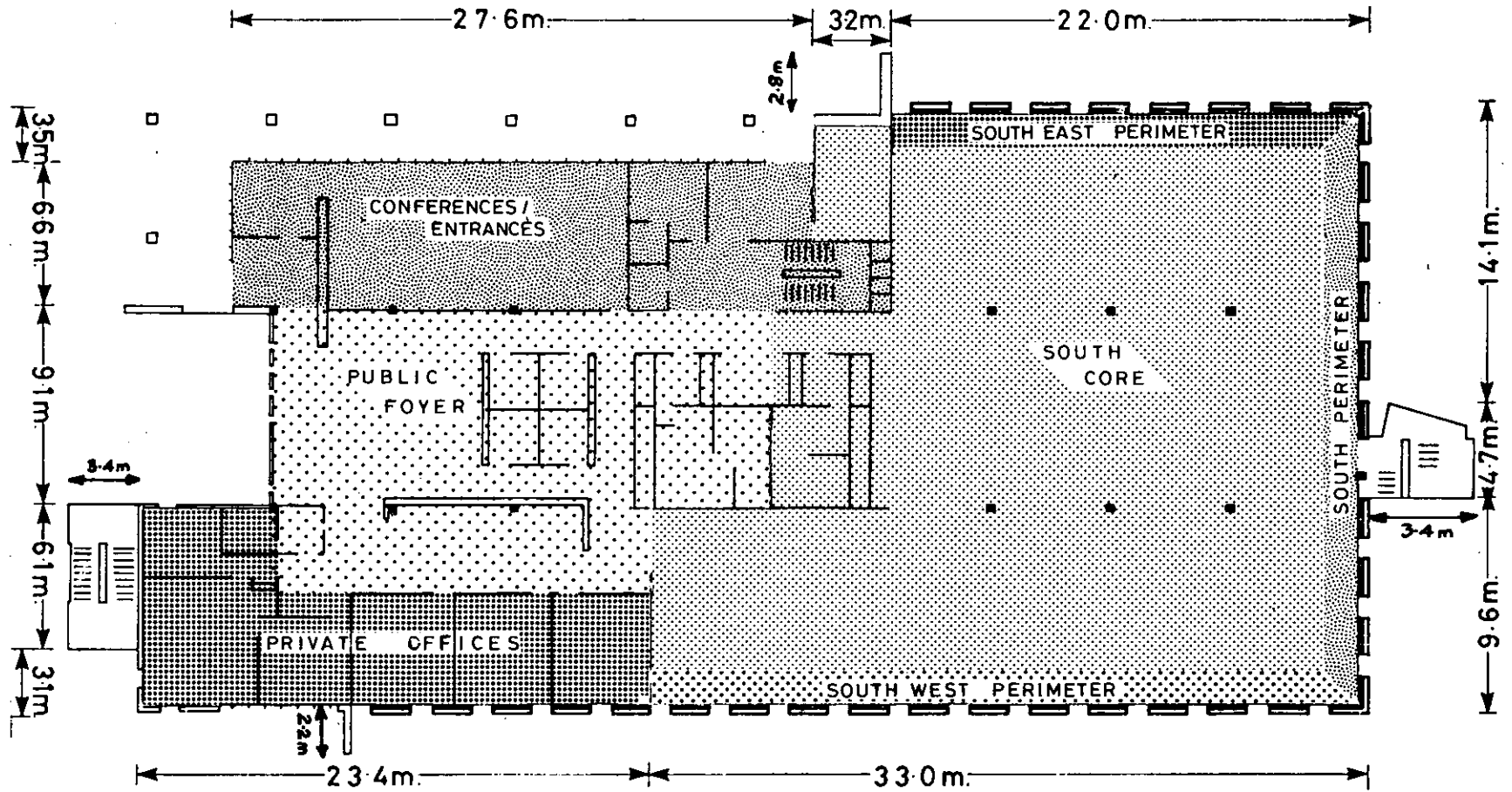

FIGURE 2: GROUND FLOOR PLAN - all perimeter zones 3m deep

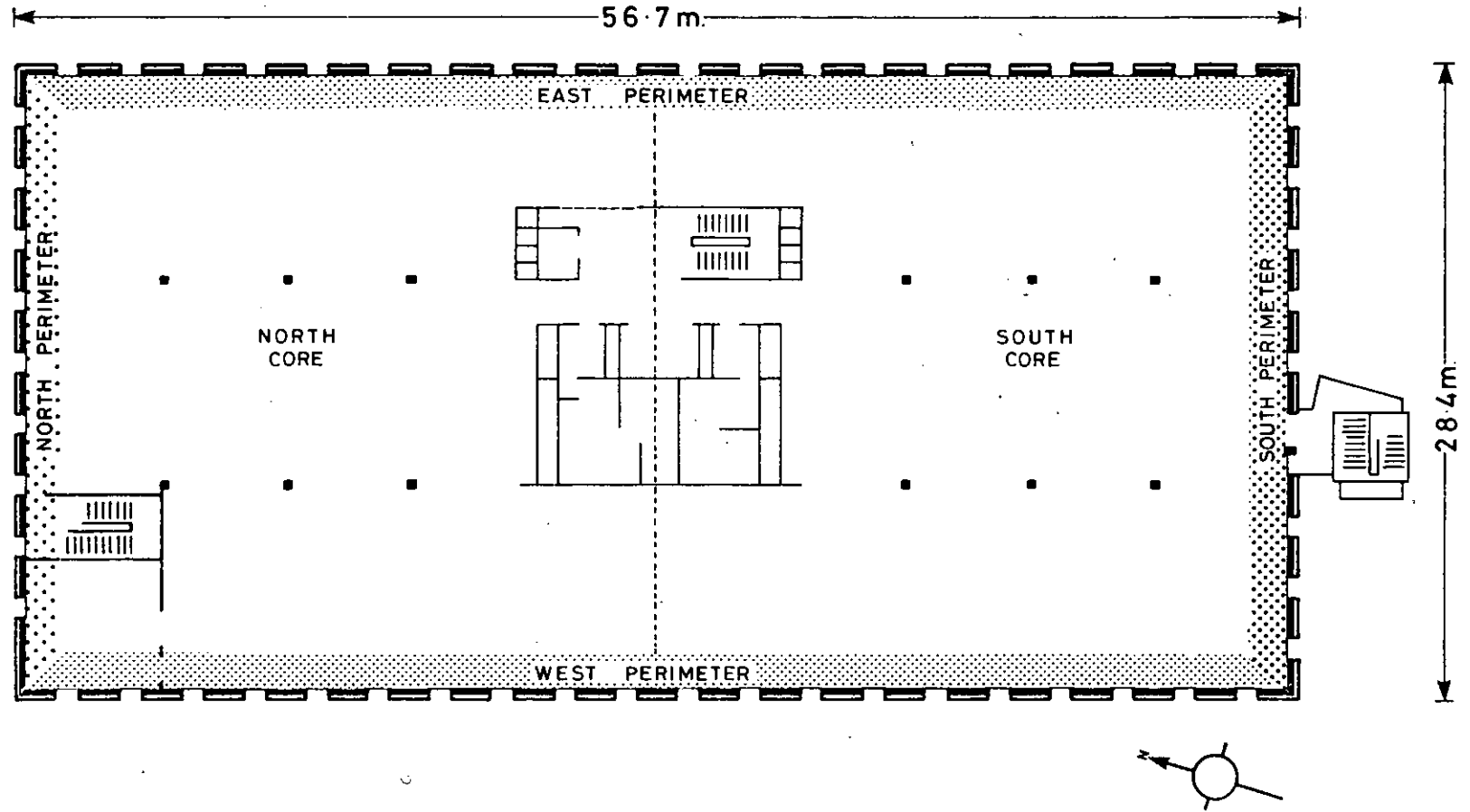

FIGURE 3: FIRST AND SECOND FLOOR PLAN all perimeter zones 3m deep.

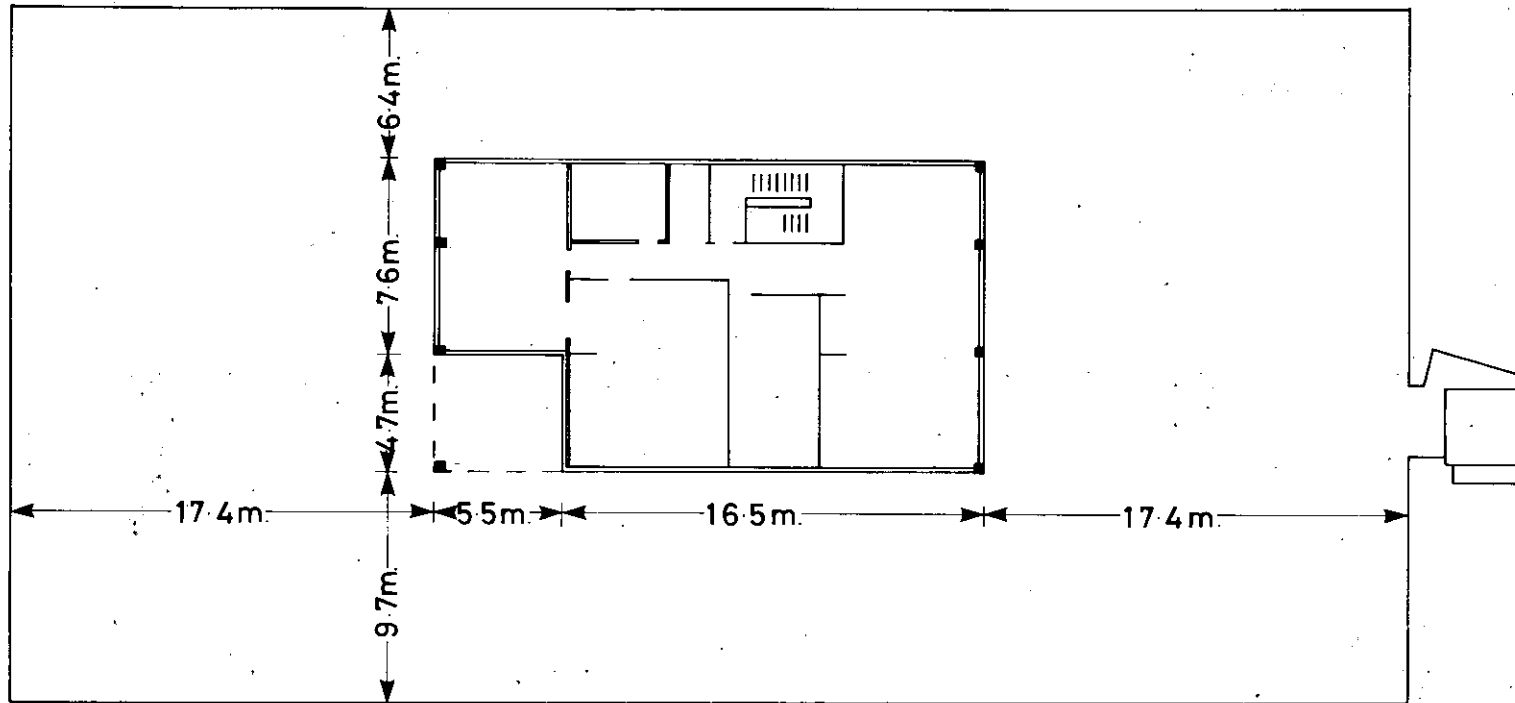

FIGURE 4: ROOF-TOP PLAN

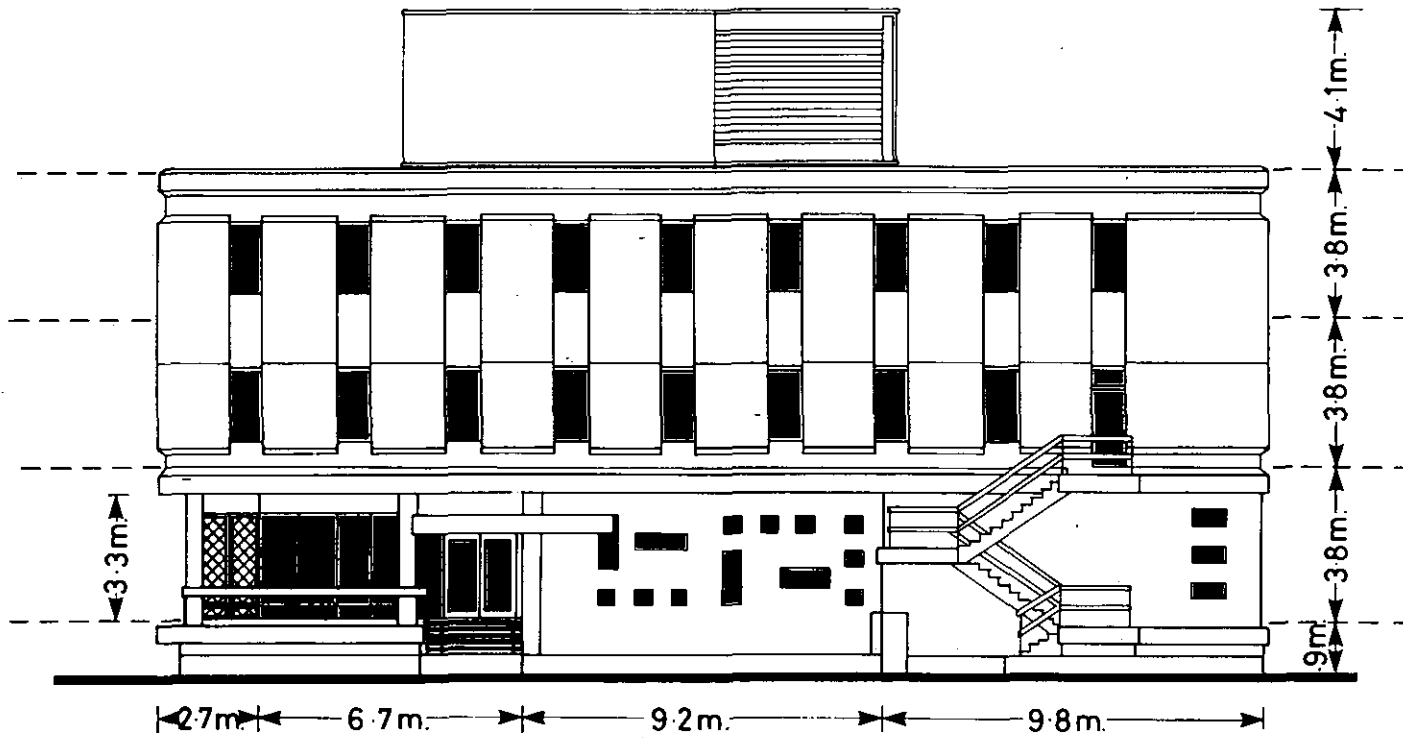

FIGURE 5: NORTH ELEVATION

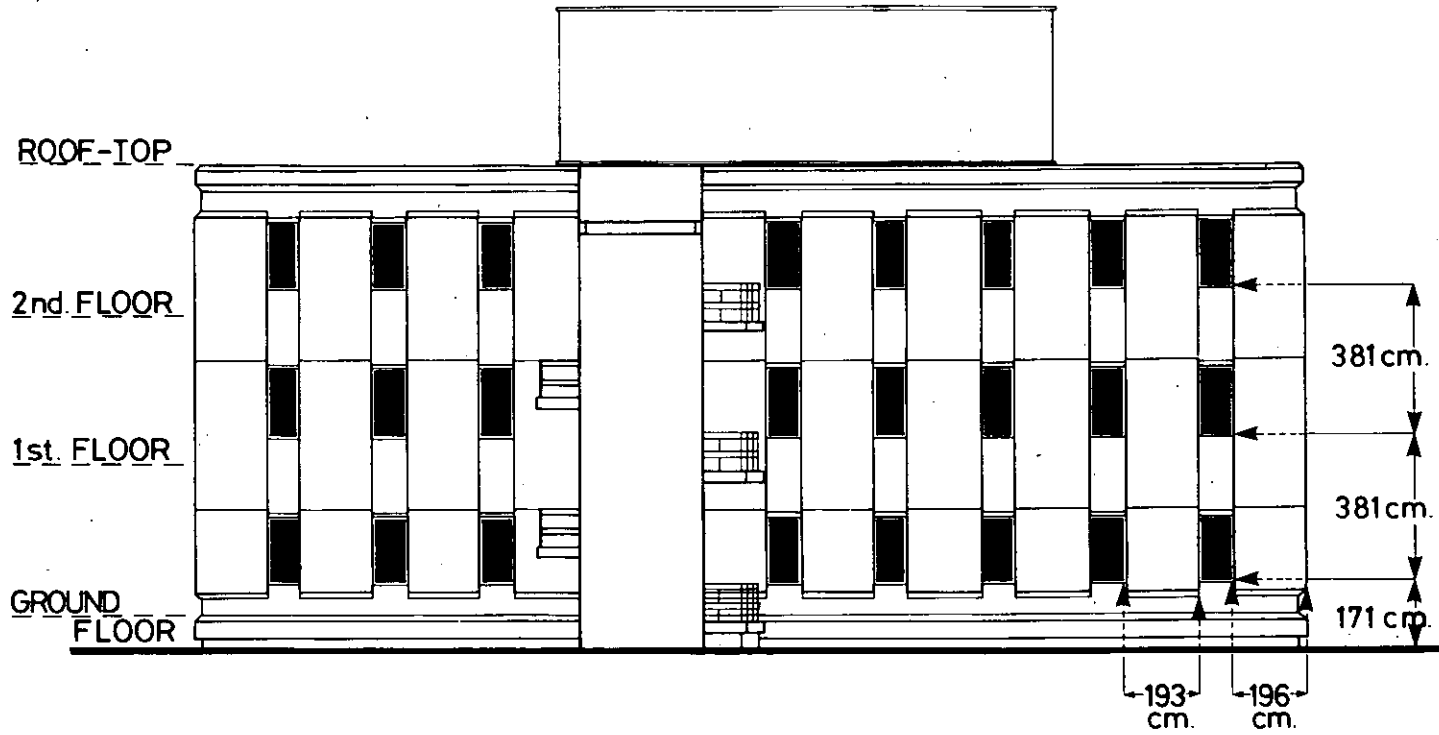

FIGURE 6: SOUTH ELEVATION

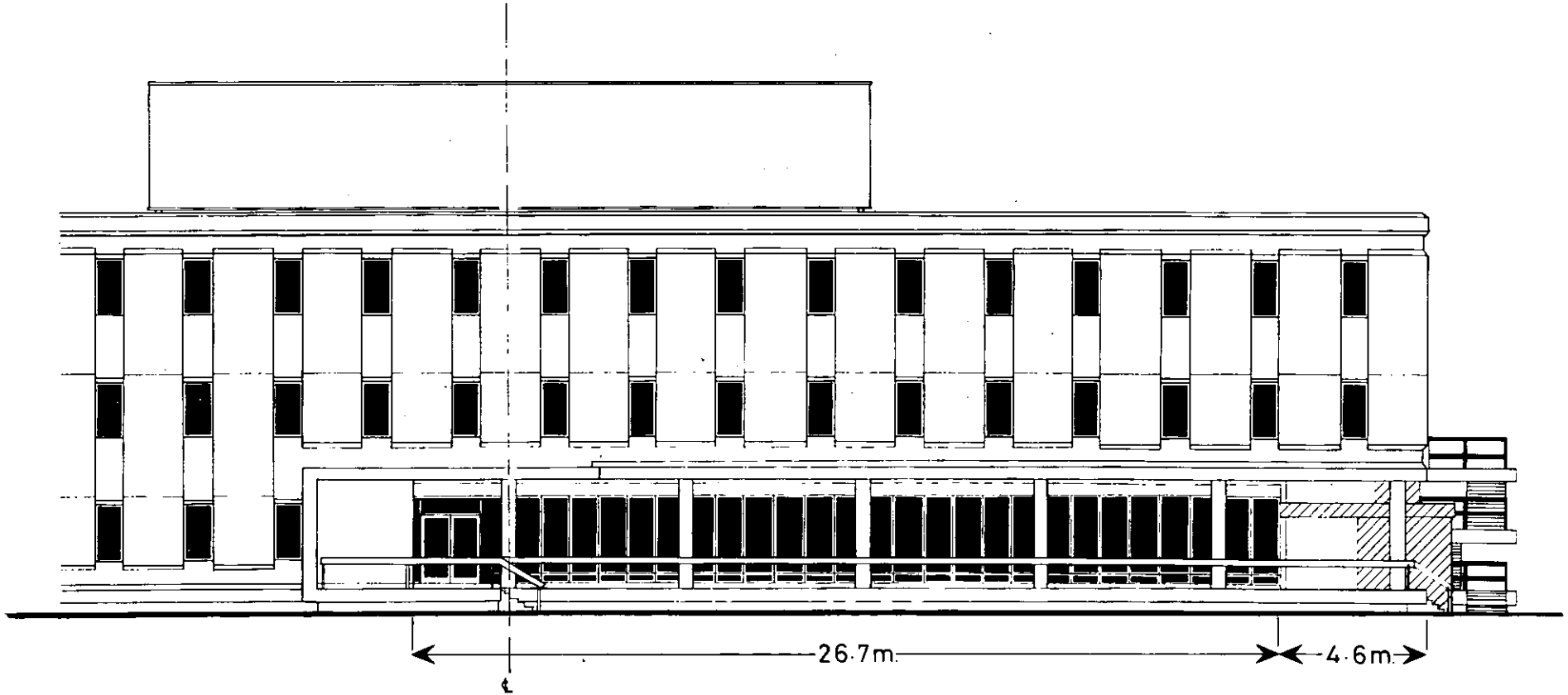

FIGURE 7: EAST ELEVATION (NORTH END)



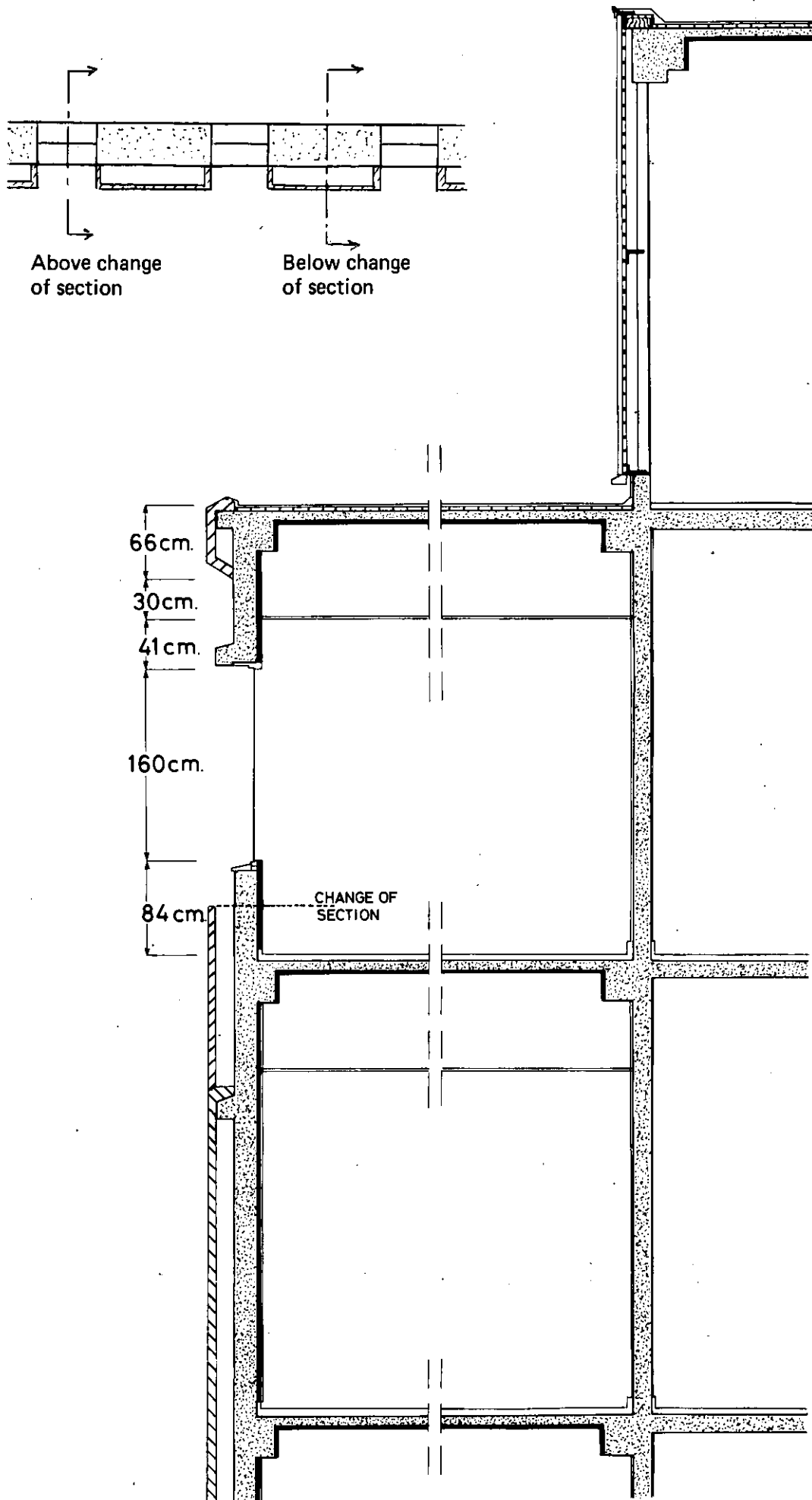

FIGURE 8: COMPOSITE VERTICAL CROSS SECTION

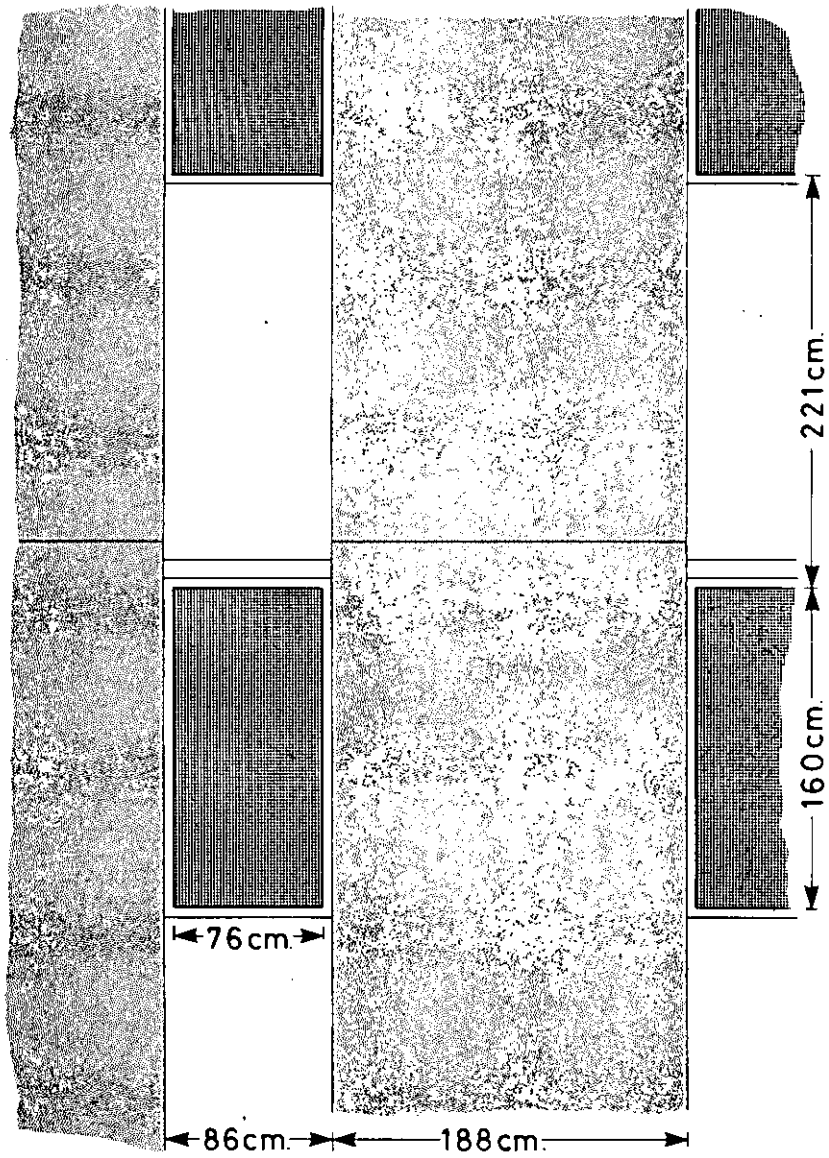

FIGURE 9: DETAIL OF EXTERNAL FACADE

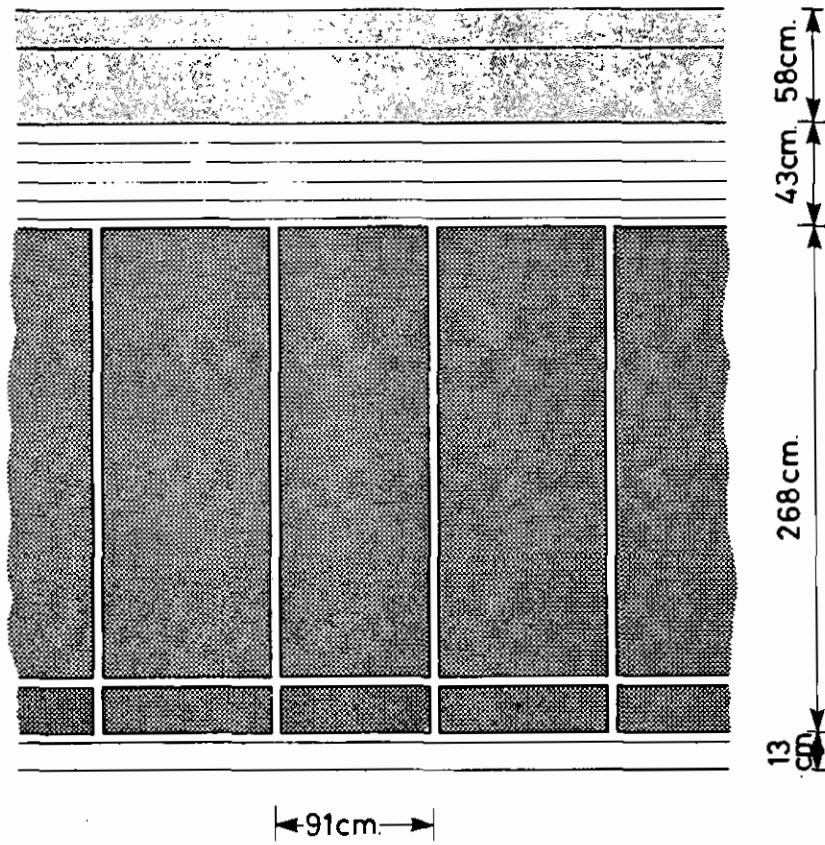

FIGURE 10: DETAIL OF EXTERNAL FACADE (CONFERENCE ROOM)

FIGURE 11: FABRIC CONSTRUCTION

**EXTERNAL WALLS**

- Mural Lionide vinyl fabric
- plasterboard prebonded by ICI to purlboard, (polyurethane rigid foam)
- stuck using Bostik pad system to Structural reinforced concrete (cast in situ).

Under windows —

- Dark green marble granules resin bonded to concrete.

Between windows —

- airgap
- reconstituted Portland capstone cladding panel

**PLANTROOM WALLS**

- Granulite facing
- 1.1.6 render
- Lignacite blockwork
- air gap
- expanded polystyrene
- 20g Embossed aluminium troughed cladding panels with double skin fixed to timber framing and m.s. sheeting rails.

**ROOF**

- White limestone chippings bedded on hot bitumious solution
- Mastic asphalte (two coats)
- Layer of black sheathing felt
- Fibreglass tissue
- Structural reinforced concrete
- Woodwool permanent formwork

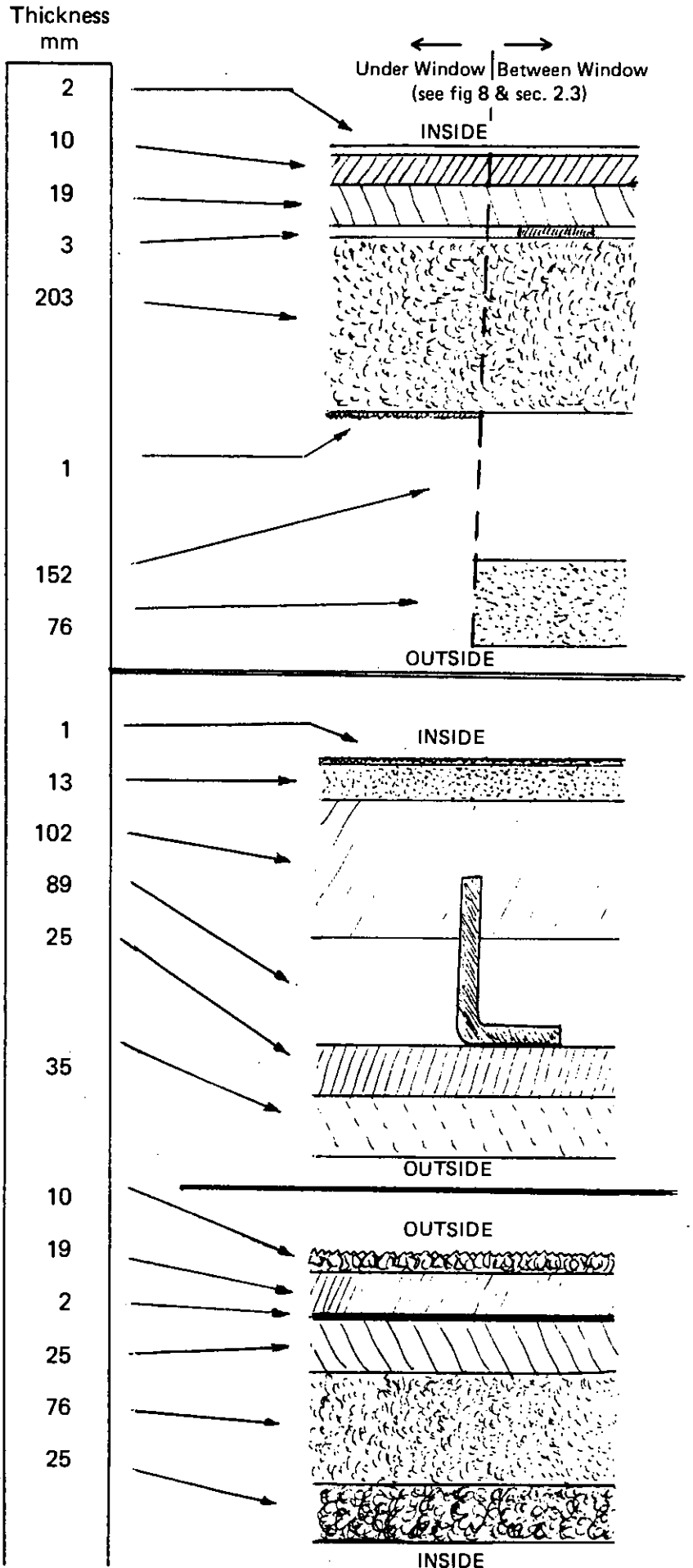

FIGURE 11 (CONTINUED)

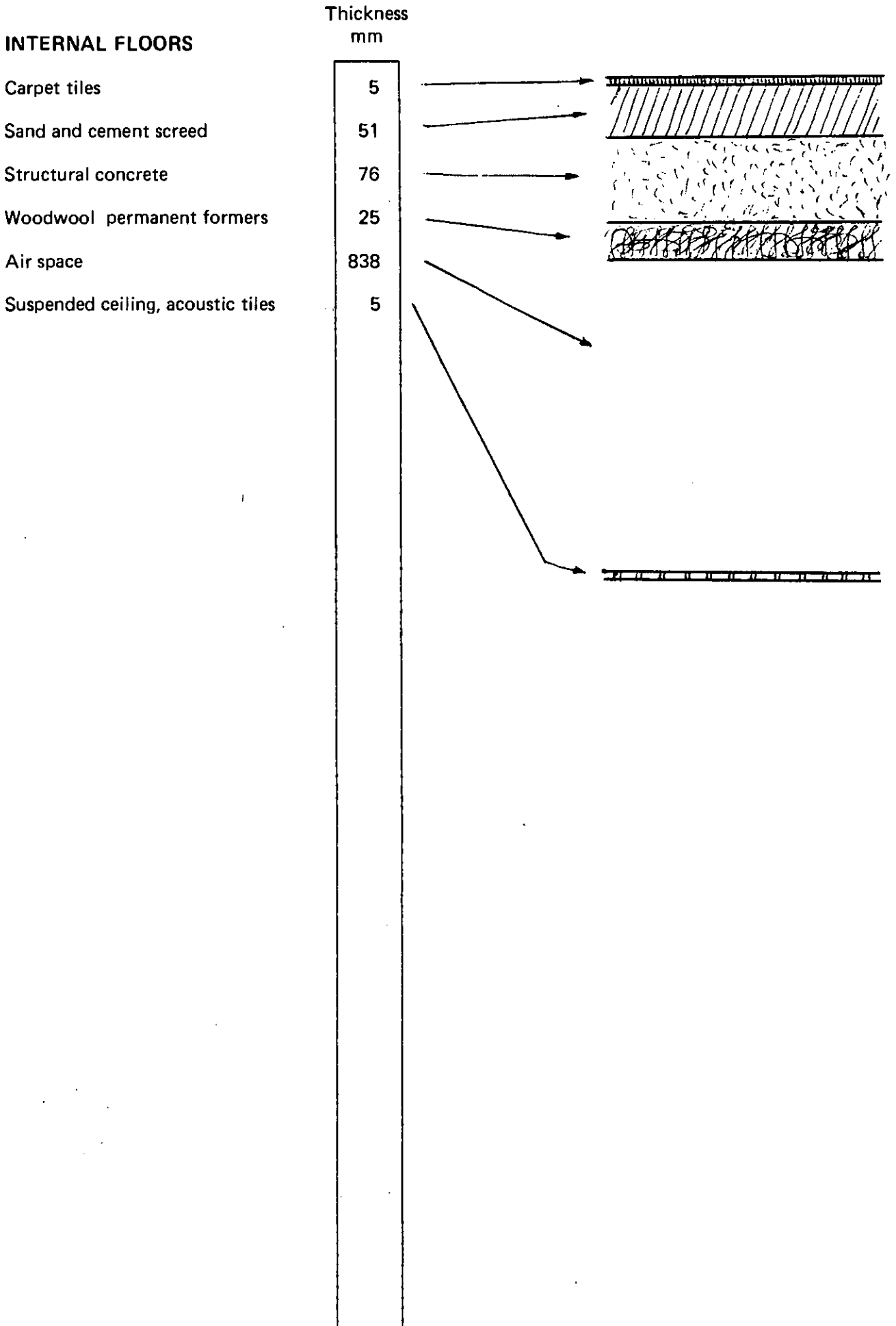
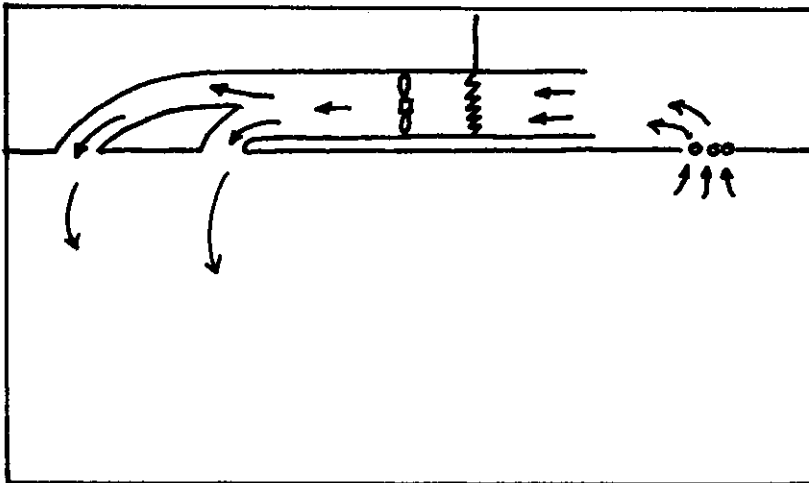
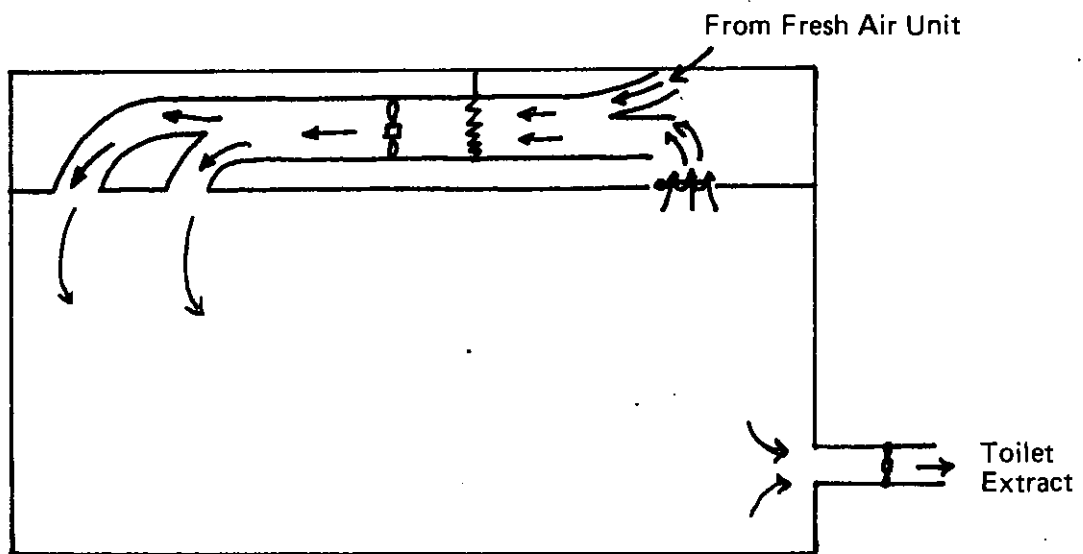

FIGURE 12 FAN COIL UNITS



Typical Fan Coil Unit – No Fresh Air supplied



Typical Fan Coil Unit – Fresh Air supplied

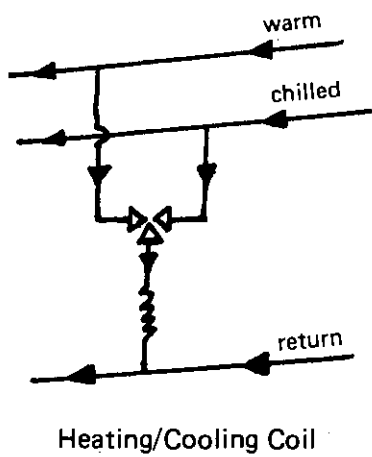

Heating/Cooling Coil

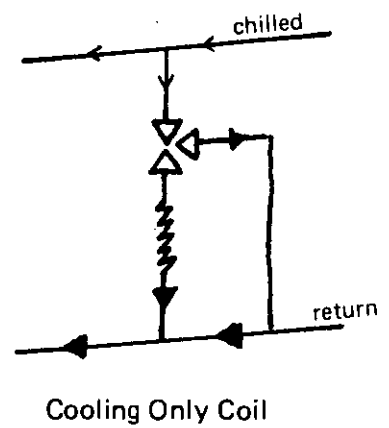

Cooling Only Coil

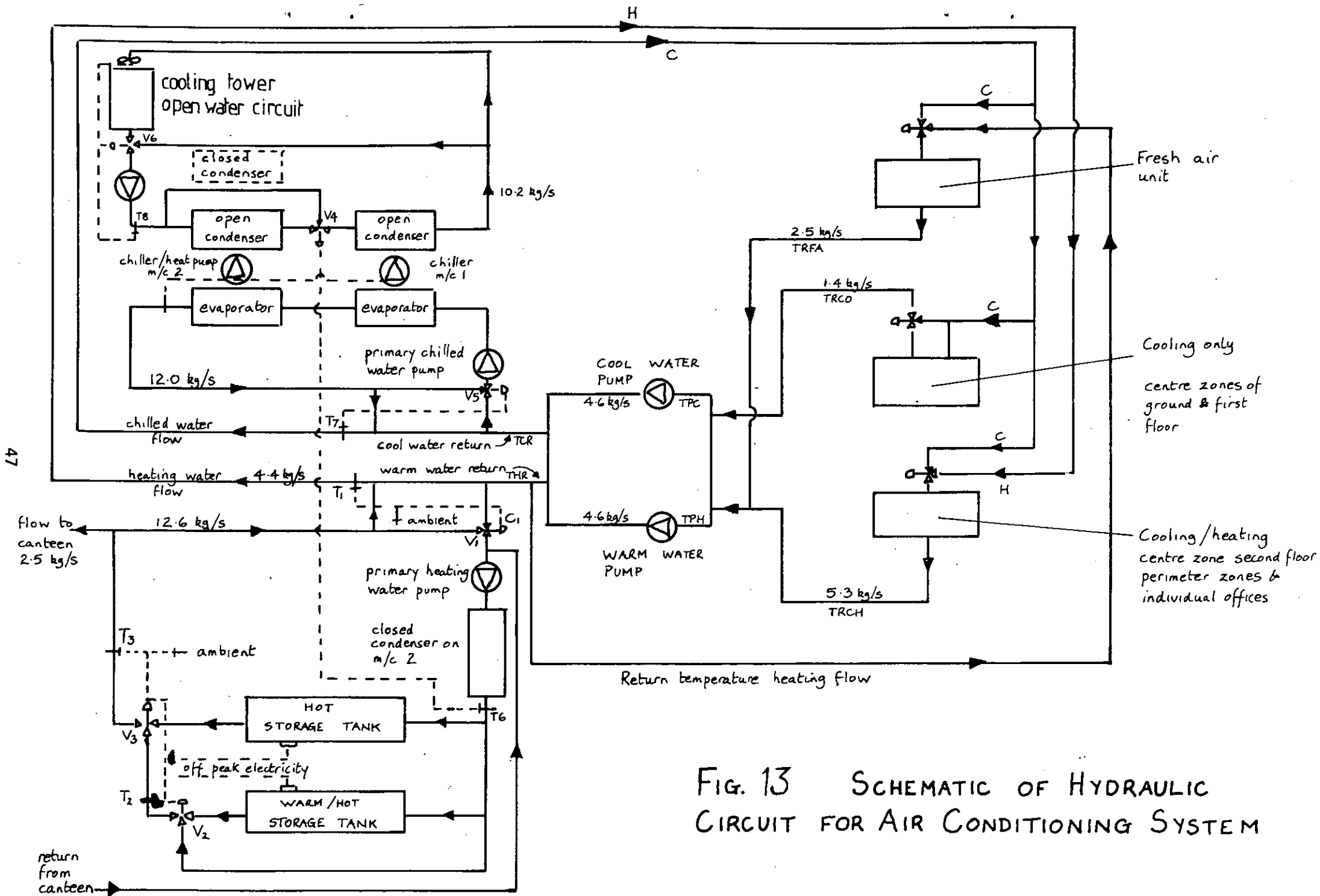
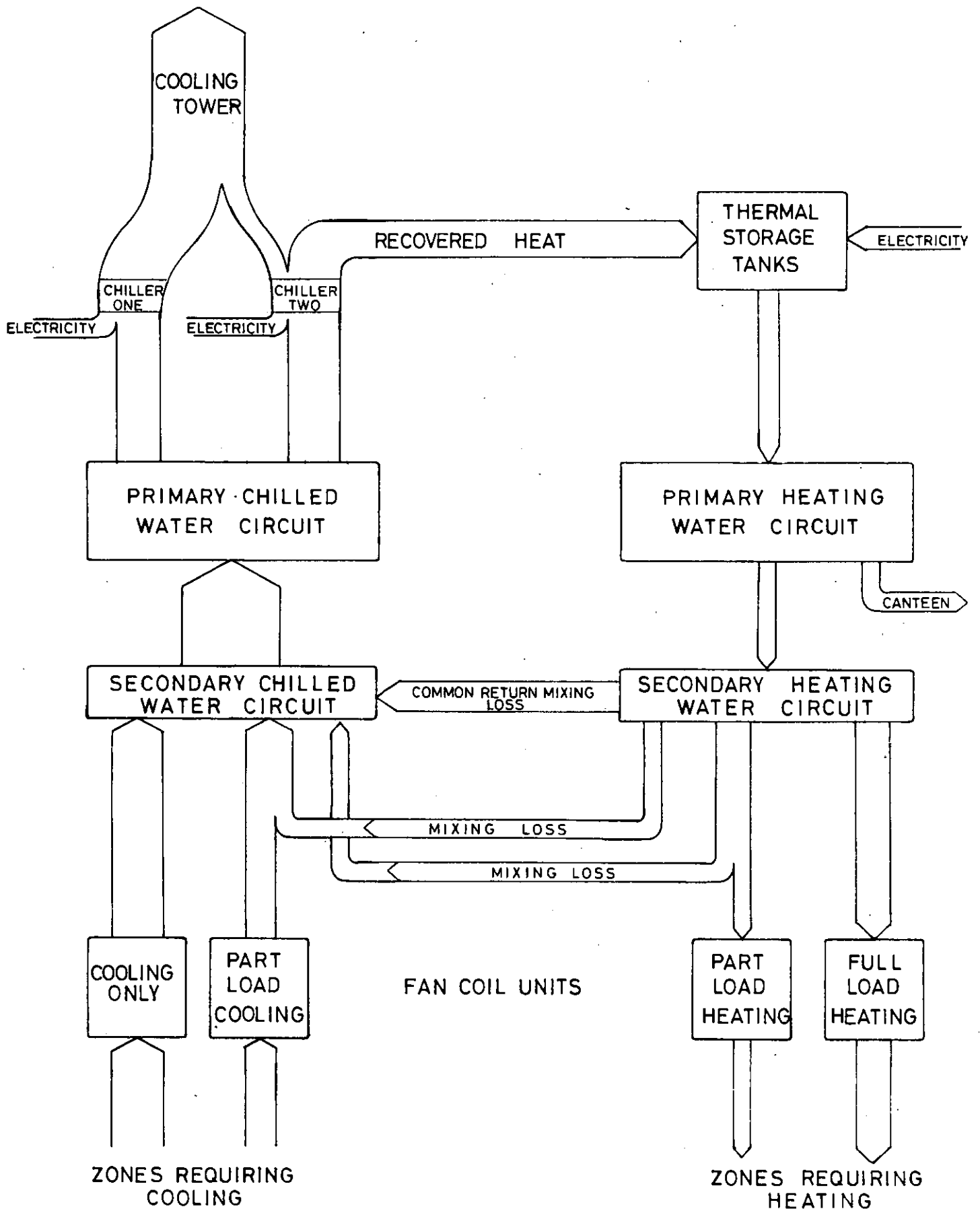

FIG. 13 SCHEMATIC OF HYDRAULIC CIRCUIT FOR AIR CONDITIONING SYSTEM



**FIGURE 14** PRIMARY AND SECONDARY SYSTEMS ENERGY FLOWS



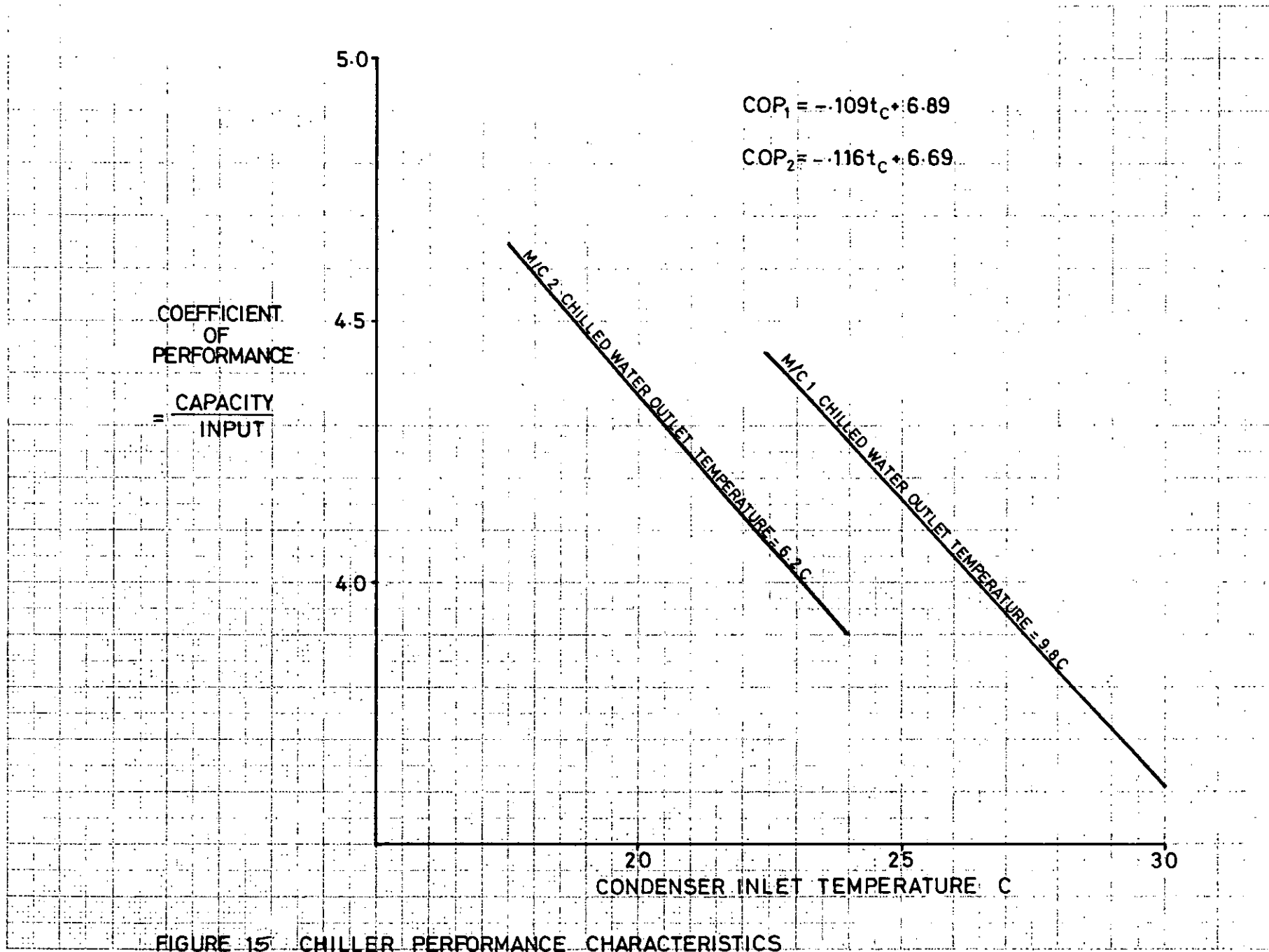
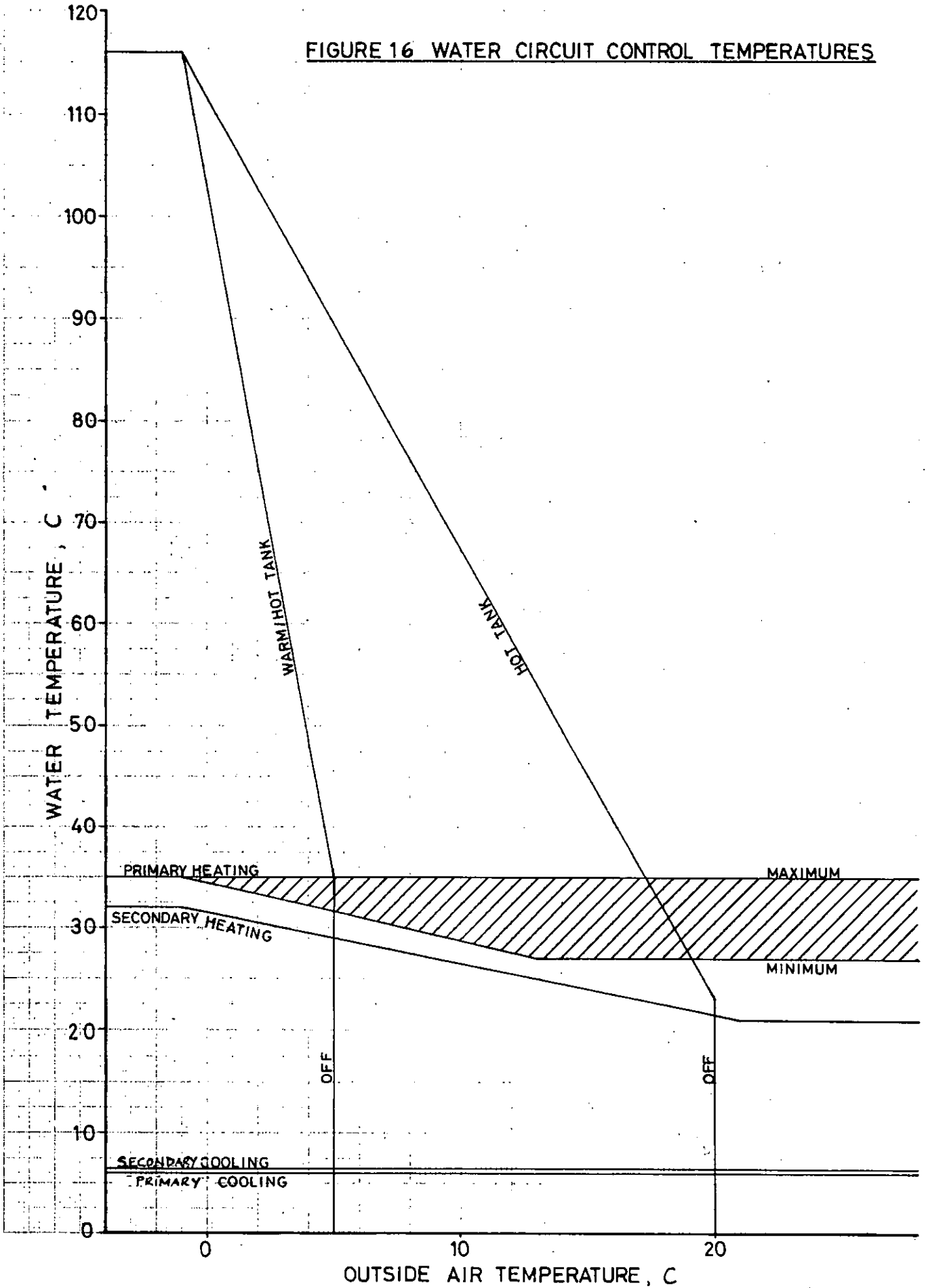

FIGURE 15 CHILLER PERFORMANCE CHARACTERISTICS

FIGURE 16 WATER CIRCUIT CONTROL TEMPERATURES



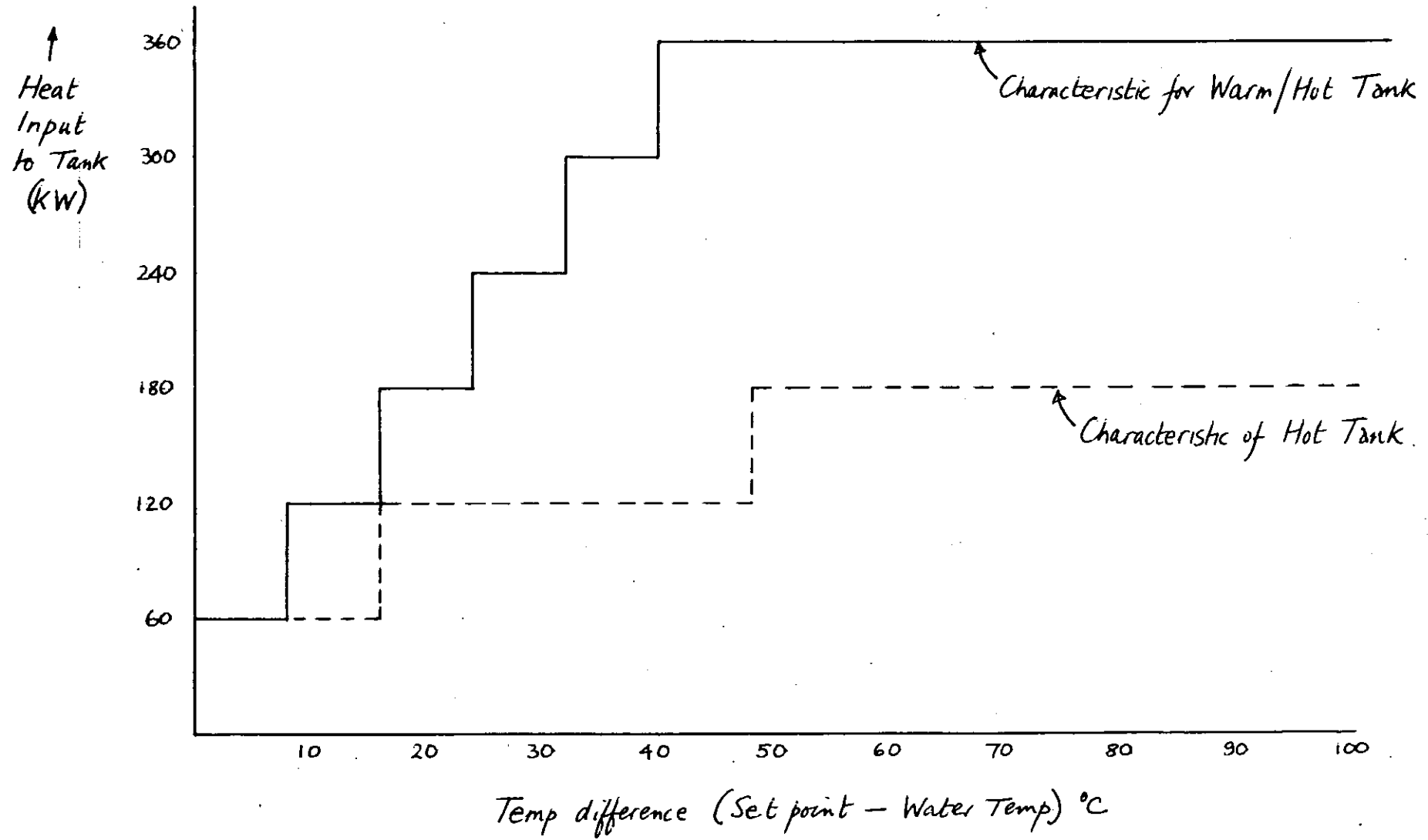
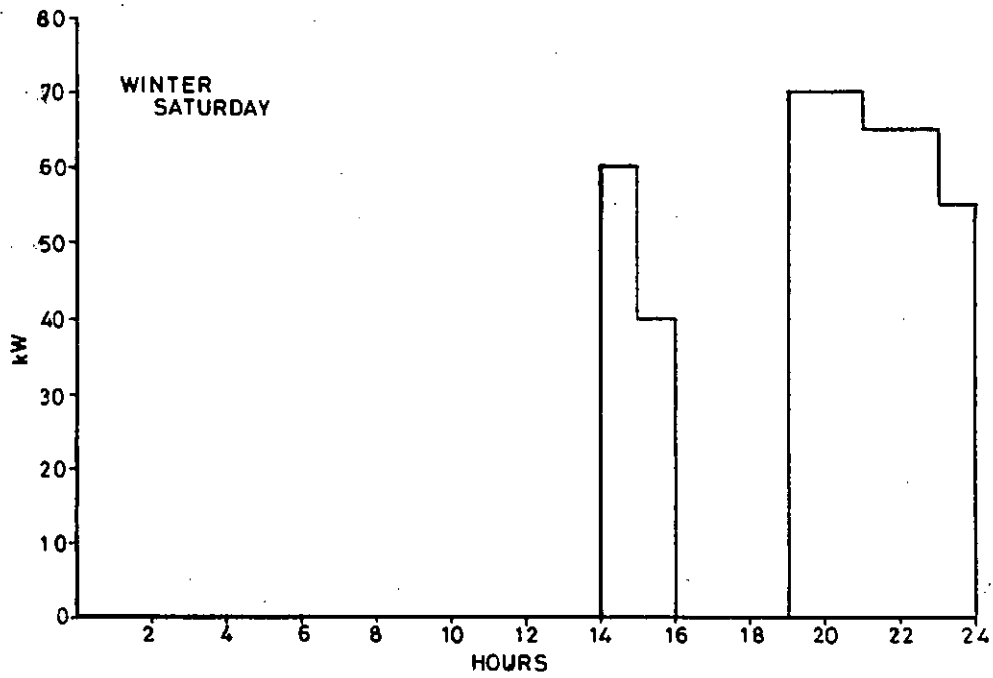
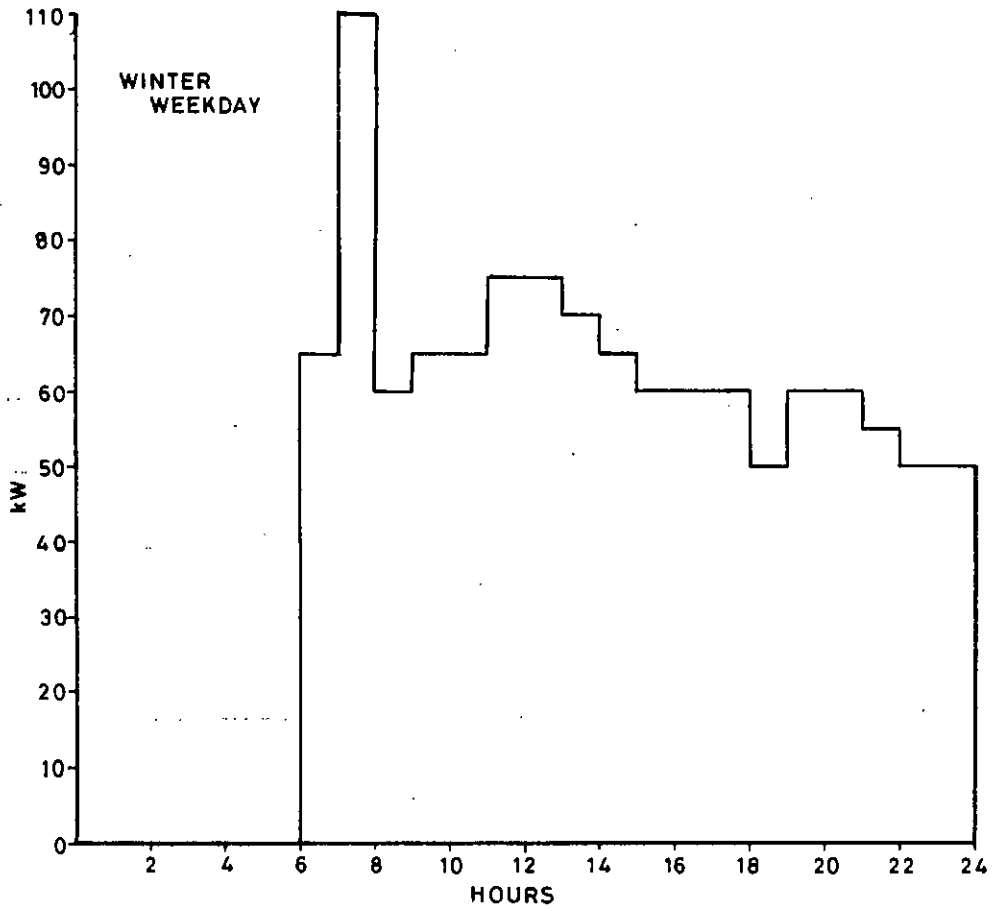
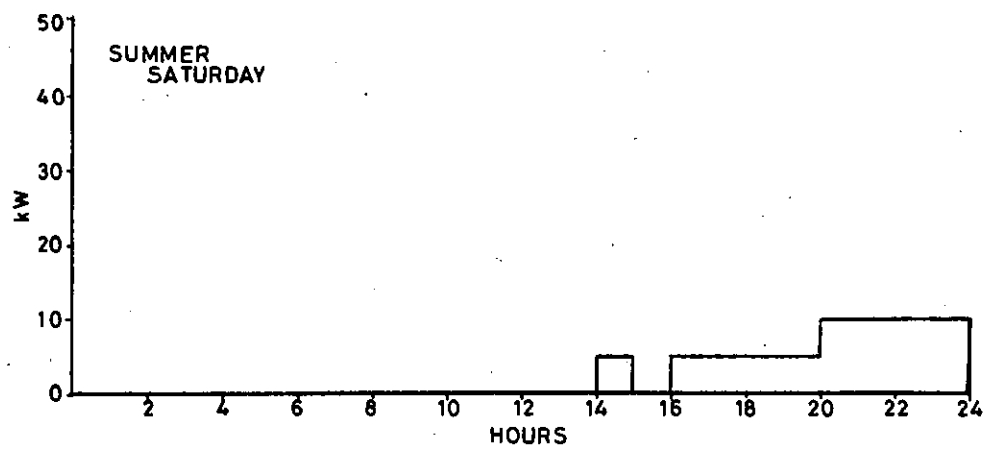
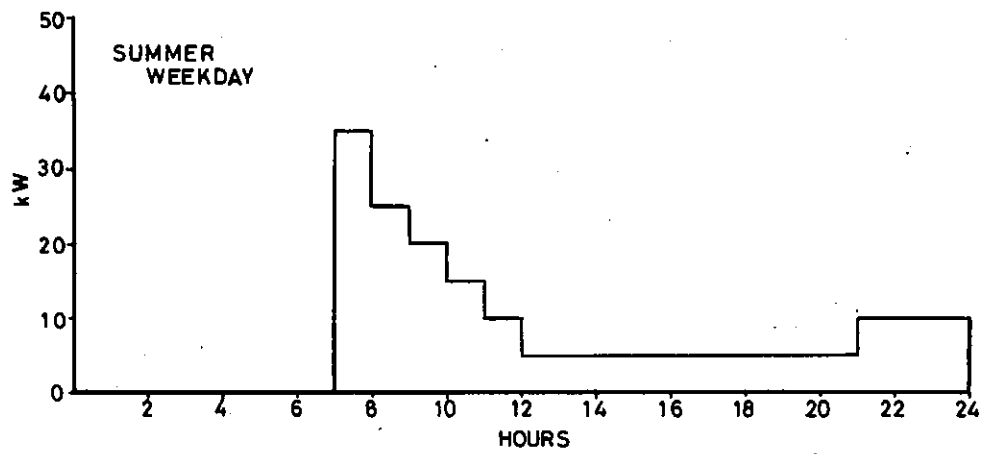
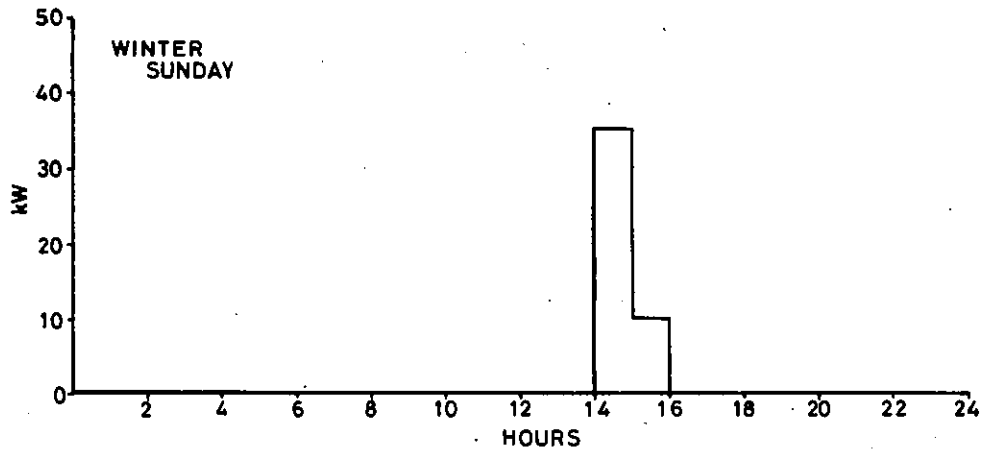

Fig 17 Control of Tank Immersion Heaters.



**FIGURE 18 CANTEEN/SOCIAL BLOCK HEATING ENERGY CONSUMPTION**



(ZERO CONSUMPTION ON SUMMER SUNDAY)

FIGURE 18 (Cont.)

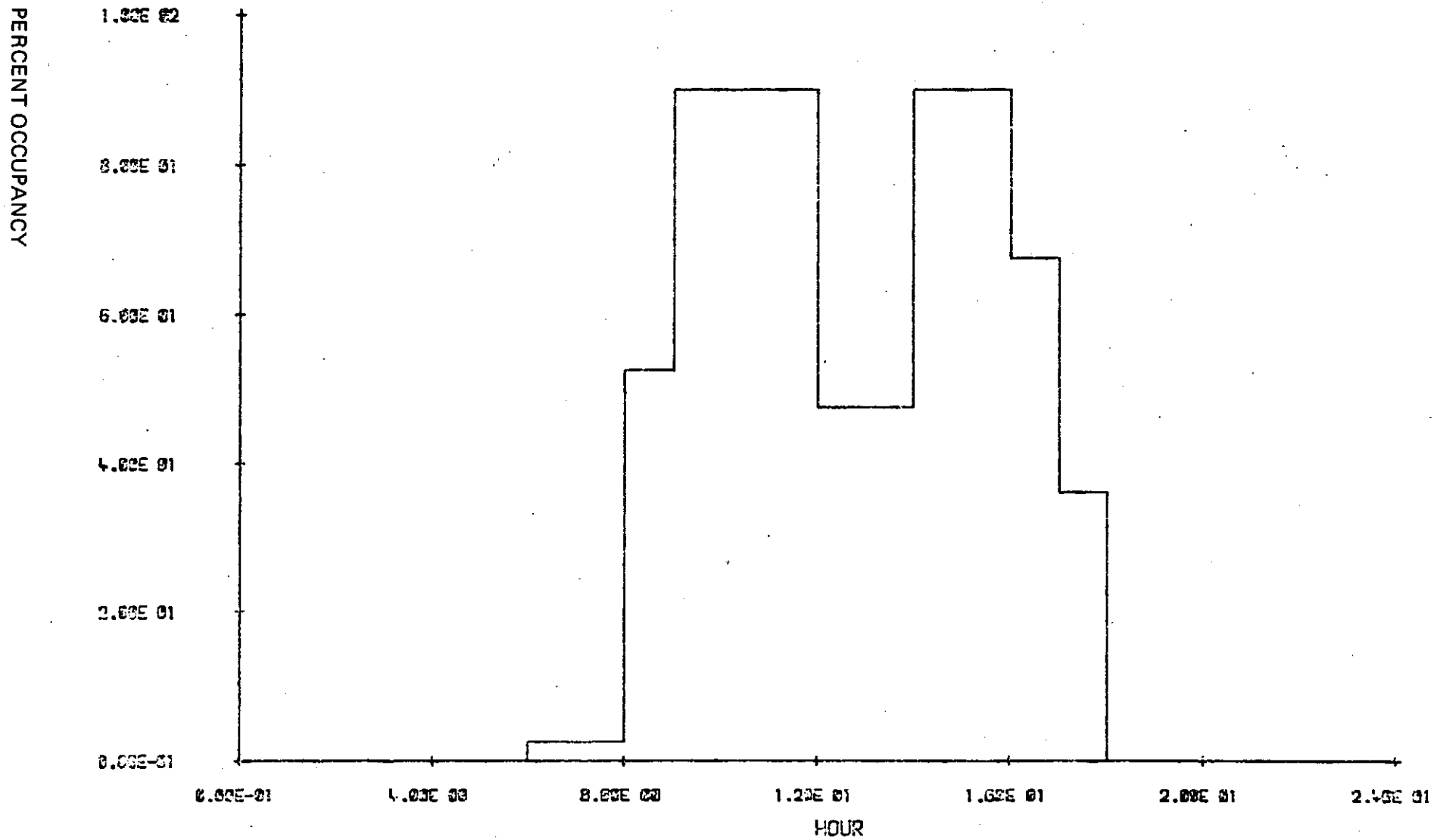
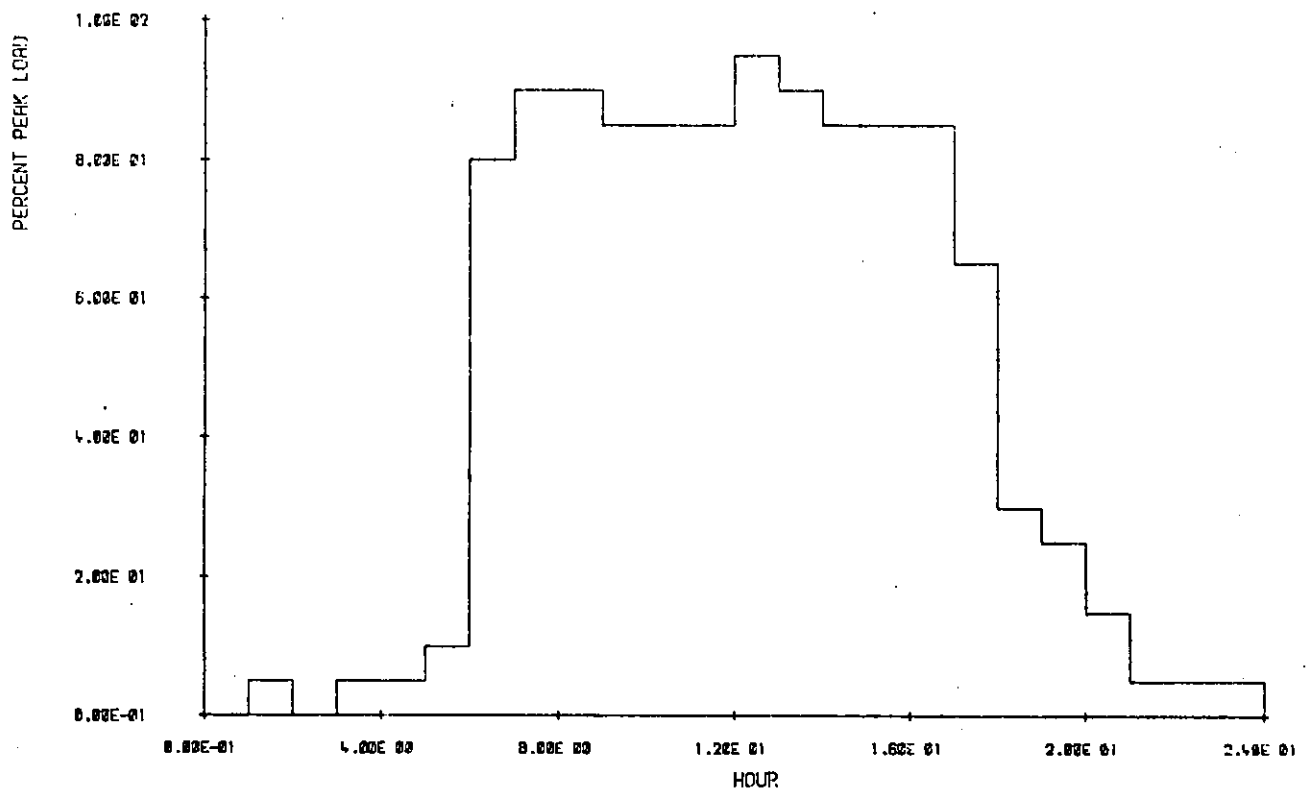
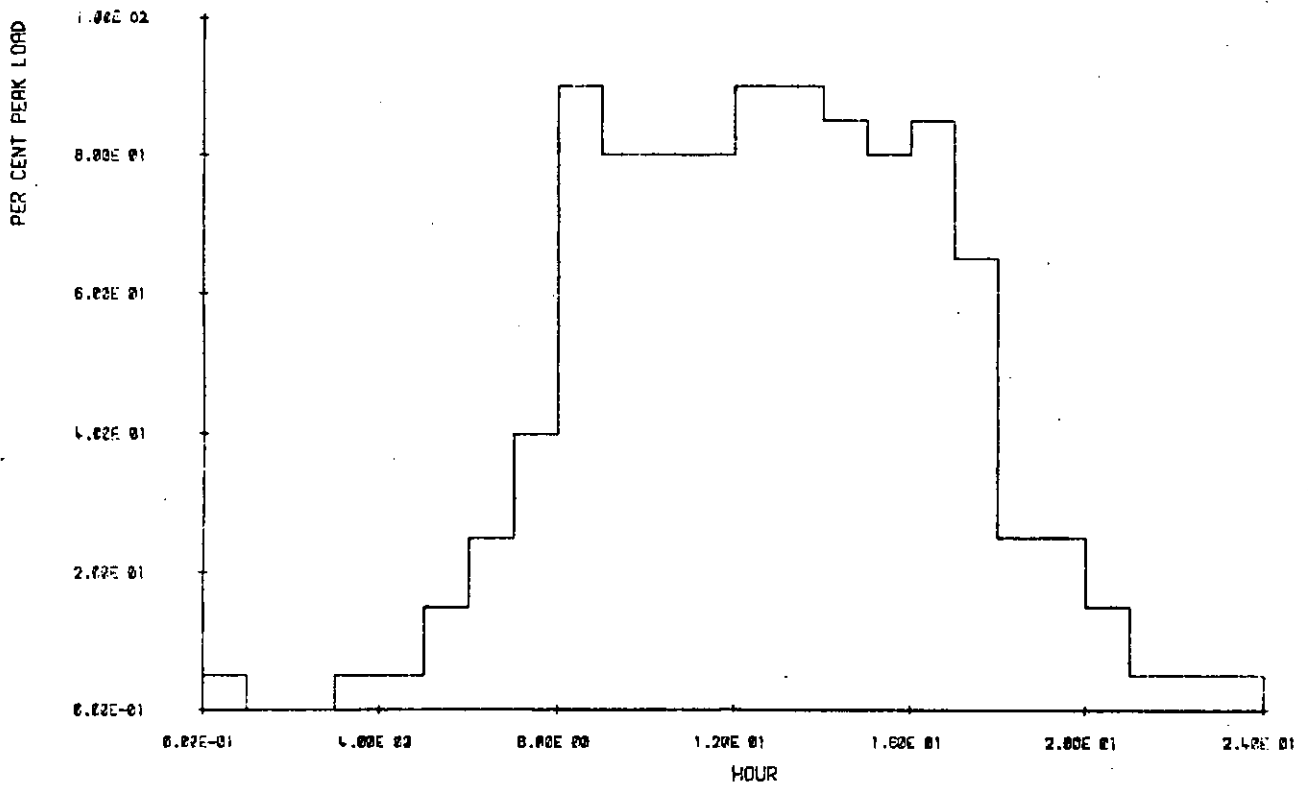

FIGURE 19-AVONBANK OCCUPANCY PROFILE--COURTESY P.BASNETT ECRC



PROFILE A



PROFILE D

FIGURE 20 LIGHTING PROFILES

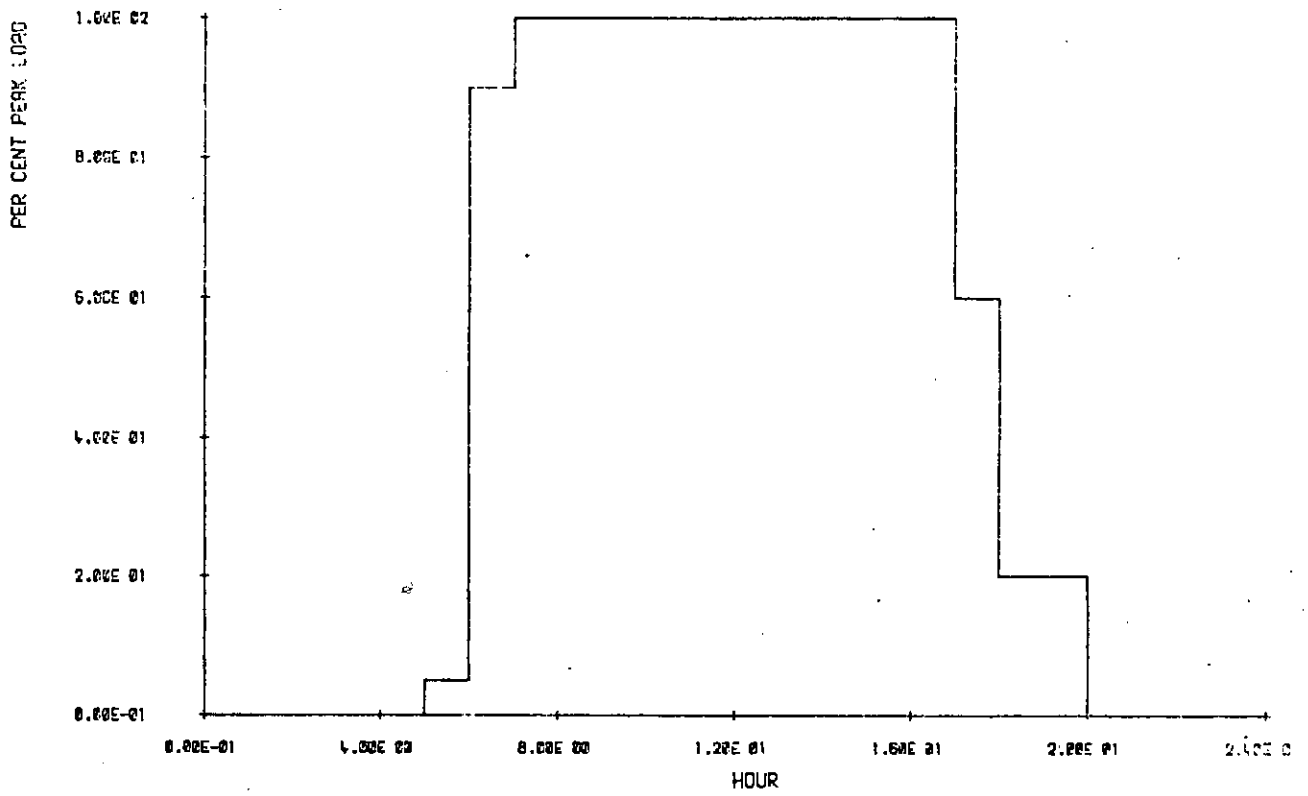

PROFILE E

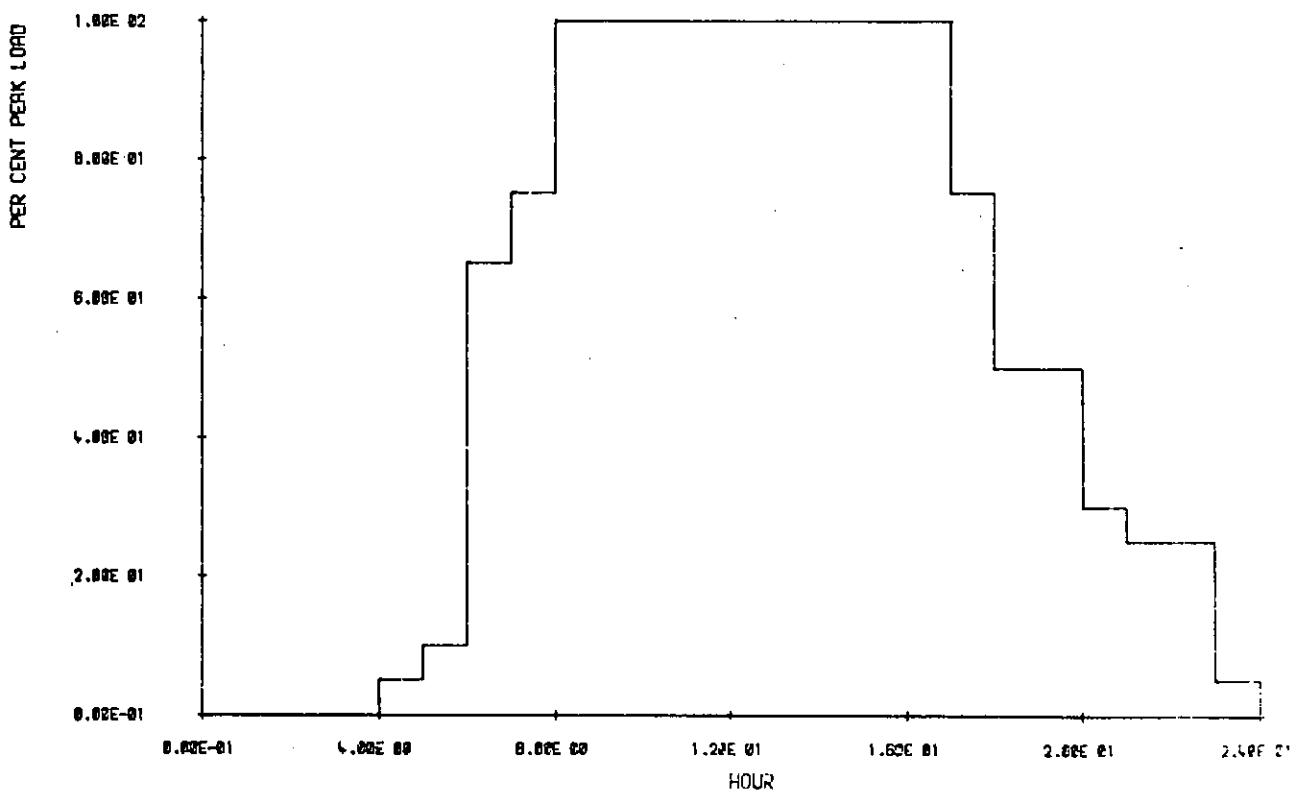

PROFILE H

FIGURE 20 LIGHTING PROFILES (CONTINUED)



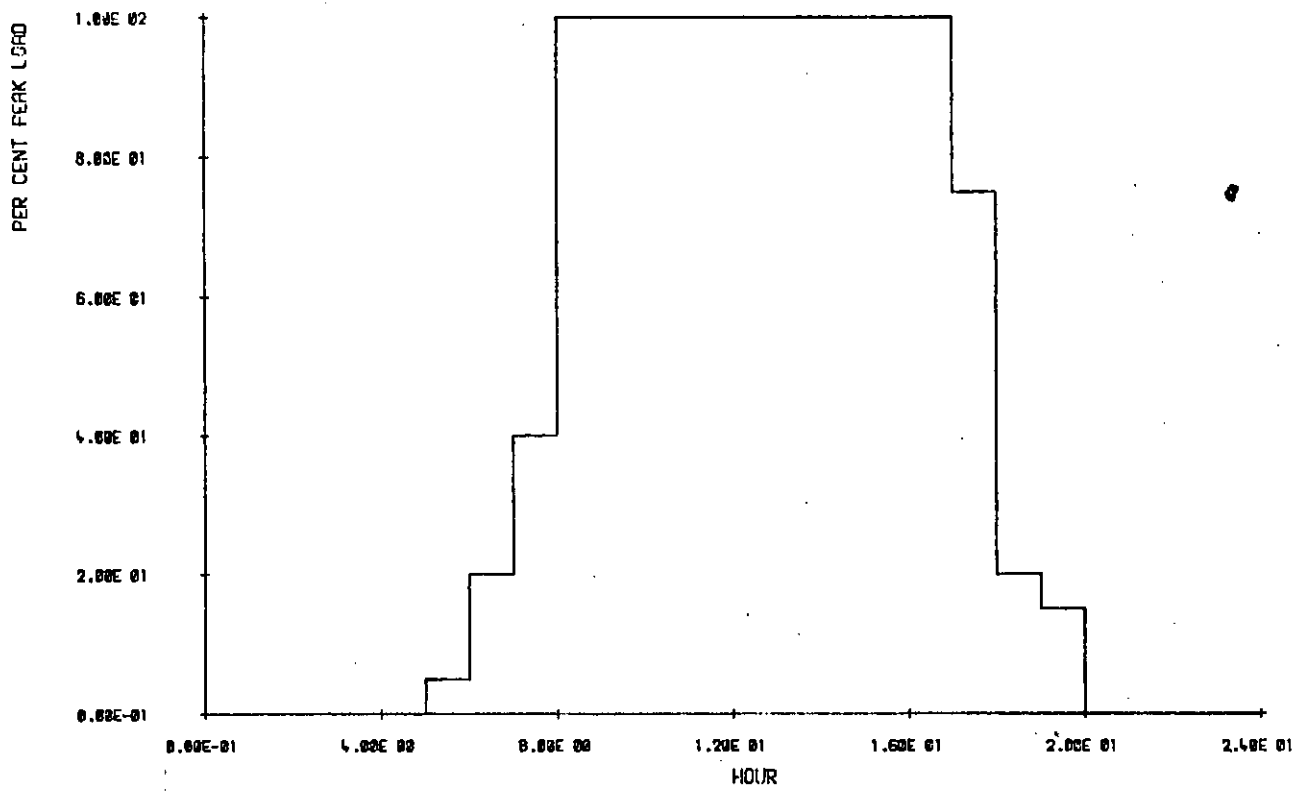

PROFILE G

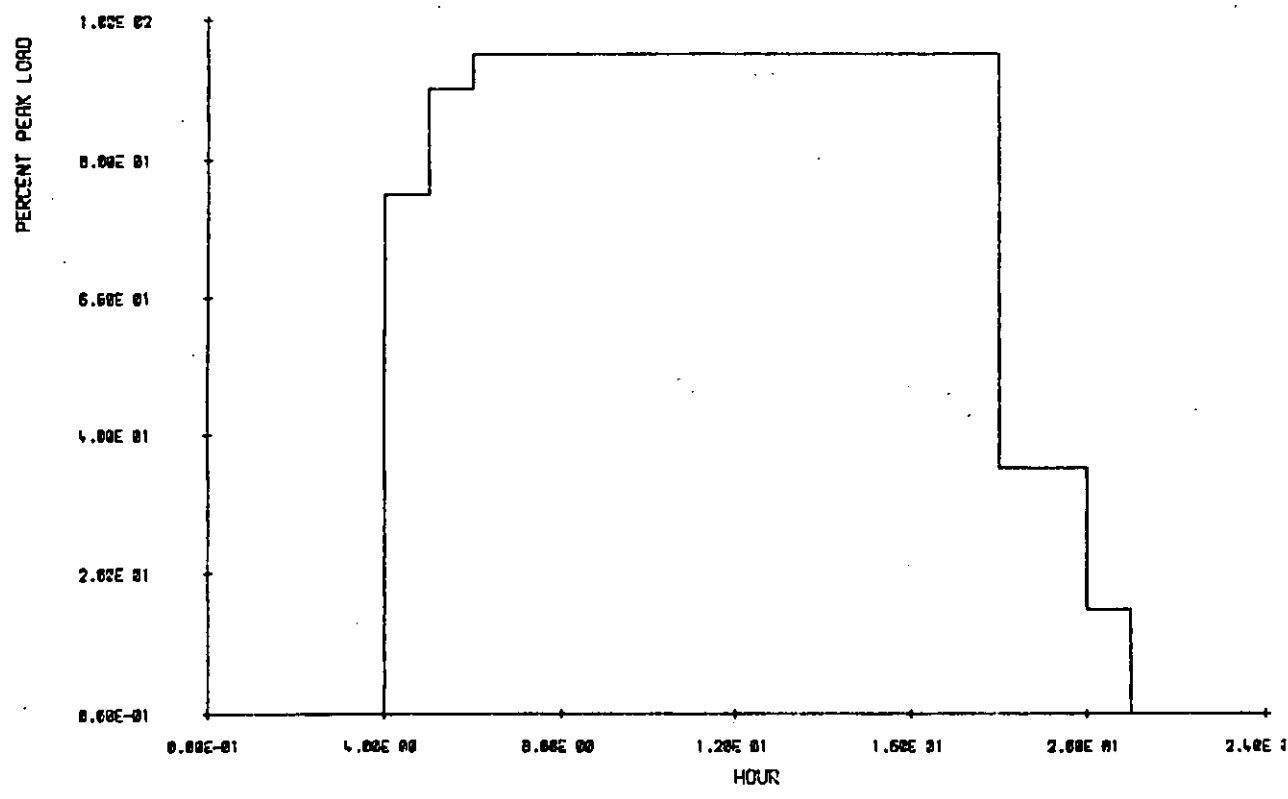

PROFILE M

FIGURE 20 LIGHTING PROFILES (CONTINUED)

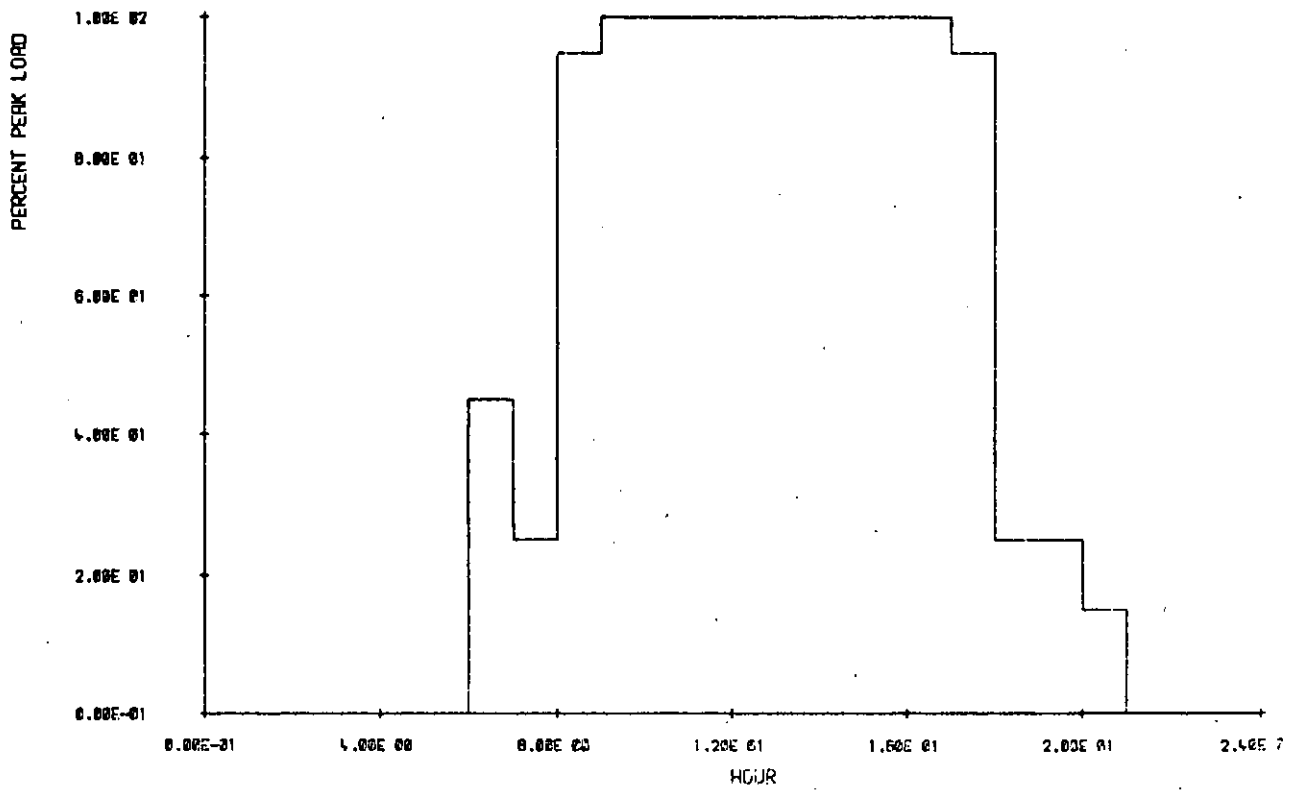

PROFILE P

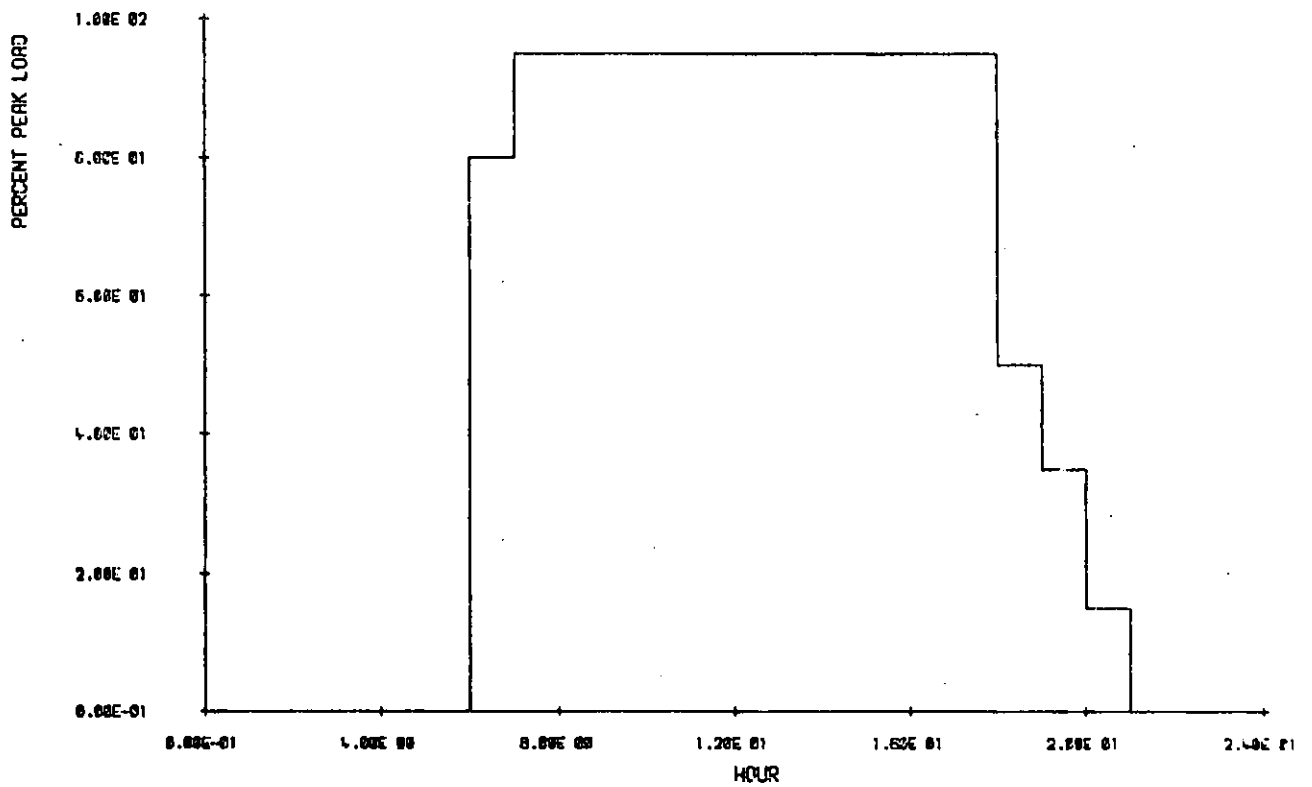

PROFILE Q

FIGURE 20 LIGHTING PROFILES (CONTINUED)

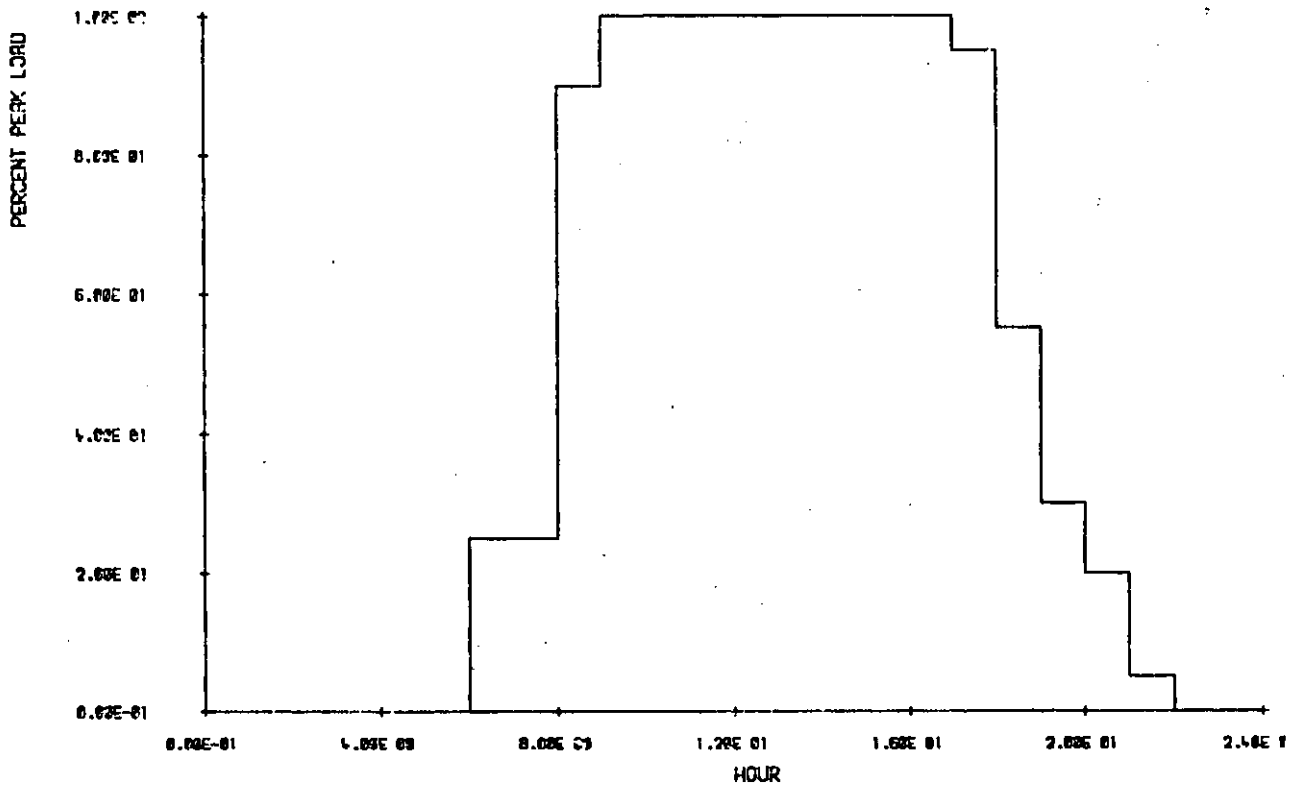

PROFILE S

FIGURE 20 LIGHTING PROFILES (CONTINUED)

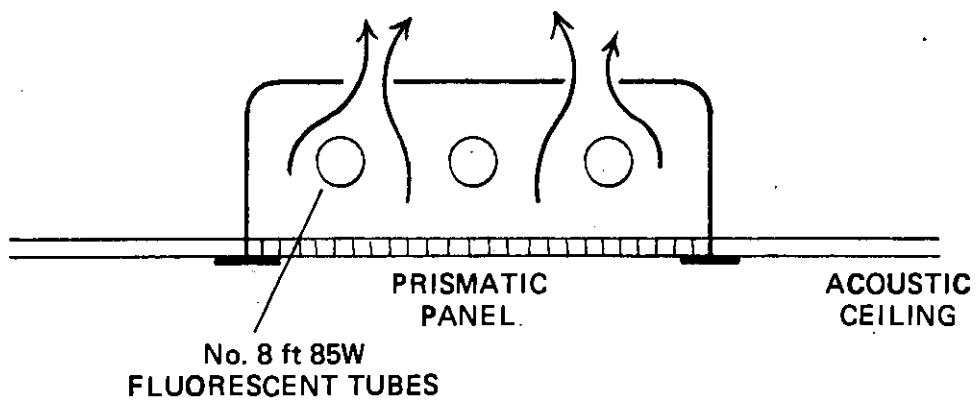

FIGURE 21 VENTILATED LIGHTING TROFFER

**APPENDIX 2**

**Building specification  
recommendations**

## APPENDIX 2 – RECOMMENDATIONS

### 1. Specifications

- (a) all the fine detail of the building should be available in drawing form for all participants to use if required. However the specification should include some rationalization of the data for convenience of the participants eg. the area of each construction type in each facade of the building.
- (b) Only underived data should be specified for the fabric material properties, ie. shading coefficients etc. should be calculated by each participant, from data contained within the specification.
- (c) All numeric information should occur as a checklist in tabular form, and not appear only in the body of the text.
- (d) Air flow rates should be referenced to some standard condition.
- (e) The specification should contain a glossary to avoid confusion over terminology.
- (f) Participants should only be asked to report heat extraction rates (see part 2), as this is the only value which has any reality in terms of measurement.

### 2. Agreed Terminology

- (1) Space Heat Gain — the rate at which heat enters into and/or is generated within a space.
- (2) Cooling Load — the rate at which heat must be removed from the space to maintain the room air temperature constant over 24 hours of the day.
- (3) Heat Requirement Rate — Rate at which heat must be removed from the space to maintain a given room air temperature.
- (4) Heat Extraction Rate — the heat extracted hour by hour from a space under the specified system of control.

ecbs bookshop

ANN 1 1980: 1 (2 OF 2)