



INTERNATIONAL ENERGY AGENCY
energy conservation
in buildings and community
systems programme

**ANNEX XIII - «ENERGY MANAGEMENT IN HOSPITALS»
A GUIDE FOR ENERGY MANAGEMENT IN HOSPITALS**

BOOKLET IV

ELECTRICAL SYSTEM

PFE
Via Nizza, 128
00198 Roma
Dicembre 1989

Ann 13 1989:1

Log 6

**ANNEX XIII - «ENERGY MANAGEMENT IN HOSPITALS»
A GUIDE FOR ENERGY MANAGEMENT IN HOSPITALS**

BOOKLET IV

ELECTRICAL SYSTEM

PFE
Via Nizza, 128
00198 Roma
Dicembre 1989

TABLE OF CONTENTS

CONTENT OF THE SIX BOOKLETS	iii
FOREWORD	1
CHAPTER 1. INTRODUCTION	2
1. Introduction	2
CHAPTER 2. ELECTRICAL ENERGY TARIFFS	3
2. Introduction	3
2.1 Description	3
2.1.1 General	3
2.1.2 The demand charge	3
2.1.3 The kilowatt hour charge	4
2.1.4 The contracted load and minimum consumption	4
2.1.5 How to calculate electricity costs	4
2.1.6 Reactive energy account	7
2.2 Strategy	8
2.2.1 Objective and procedure	8
2.2.2 Measuring techniques	9
2.3 How to save energy with minor changes	10
2.3.1 Updating of tariff parameters	10
2.3.2 Avoiding of coincident peak loads	10
2.3.3 The hospital's internal cost distribution as an incentive for energy cost reduction	10
2.4 How to save energy by modifying installations	12
2.4.1 Maximum load control system	12
CHAPTER 3. TRANSFORMERS	14
3. Introduction	14
3.1 Description	14
3.2 Strategy	15
3.3 How to save energy with minor changes	16
3.3.1 Reduction of transformer capacity in low load periods	16
3.3.2 Optimization of the parallel operation of several transformers	17
3.4 How to save energy by modifying installations	19
3.4.1 Replacing old transformer units	19
3.4.2 Installation of additional transformer units	19
CHAPTER 4. ENERGY DISTRIBUTION NETWORK AND	20
4. Introduction	20
4.1 Description	20
4.2 Strategy	20
4.3 How to save energy with minor and/or major changes	21

4.3.1 Replacing cables through more cost efficient ones	21
4.3.2 Installation of decentral compensation capacitors	22
CHAPTER 5. ELECTRICITY CONSUMERS FOR THE PROCUREMENT OF THERMAL OR MECHANICAL ENERGY	25
5. Introduction	25
5.1 Description	25
5.1.1 General	25
5.1.2 Electrical drives	25
5.1.3 Electrical heaters	26
5.2 Strategy	26
5.3 How to save energy with minor changes	27
5.3.1 Trouble shooting and maintenance	28
5.3.2 Changes in the modes of operation	28
5.4 How to save energy with modifying installations	29
5.4.1 Installation of cold storage	29
5.4.2 Decentral installation of control facilities for ventilation systems	29
5.4.3 Optimize drive motors for ventilations and other purposes	29
5.4.4 Installation of electronic control units for electric motors	30
CHAPTER 6. LIGHTING	31
6. Introduction	31
6.1 Description	31
6.1.1 General	31
6.1.2 Lamps	32
6.1.3 Ballasts and starters	34
6.1.4 Luminaries	34
6.1.5 Control systems	34
6.2 Strategy	36
6.3 How to save energy with minor changes	39
6.3.1 Actions in maintenance	39
6.3.2 Actions with operational changes	42
6.3.3 Actions concerning the room surfaces	43
6.4 How to save energy with modifying installations	43
6.4.1 General	43
6.4.2 How to approach	44
6.4.3 Measures to be taken	45

CONTENT OF THE SIX BOOKLETS

Booklet I

Introduction to the Booklets and the Management Perspective

Object of this Booklet is helping Institutions to identify the requirements, fund structures which support the initiatives, carry out certain procedures and ensure that the comfort of the facility is maintained, as well as the proper service, and energy with its associated cost is minimized.

Objectives of an Energy Management Program are reported, with indications for the development of such program.

Practical worked examples for Energy Conservation Opportunities are also included.

Content:

- Foreword
- 1. Background
- 2. Introduction
- 3. Developing an Energy Management Program
- 4. Energy Accounting Techniques
- 5. Phases of the Energy Management Program
- 6. Energy Management Investments
- 7. Conclusion
- 8. Checklist
- 9. Acknowledgements
- 10. Appendix A - Conversion Factors
- 11. Appendix B - Bibliography

Booklet II

Heat Generation and Distribution Cold Generation and Distribution

The main objectives of this Booklet are to provide a sound basis for the approach of thermal energy management, including both heat and cold generation; it is divided in three main parts: heat generation, heat distribution, cold generation and distribution.

The heating energy may be supplied by means of conventional boilers, heat pumps, or through a district heating system.

The cooling energy is usually provided by chillers equipped with compression or absorption cycles.

All systems are described, in order to understand their principles and mode of operation, pointing out how to act on them, in order to attain an energy efficient operation.

Energy Saving Opportunities are reported, mostly with minor changes on existing installations.

Content:

- Foreword
- 1. Heat Generation
- 2. Heat Distribution
- 3. Cold Generation and Distribution

Booklet III

**Heating, Ventilating, Air Conditioning
Domestic Hot Water**

The Booklet focuses on the requirements of the various zones of a hospital, and how they can be met in an energy efficient way, by means of Heating, Ventilating, Air Conditioning systems (HVAC).

Detailed description of such systems is reported with indications of the Standards and special requirements specified for hospitals.

Examples of Energy Conservation Opportunities for the management and maintenance of systems are also included.

A chapter deals with Domestic Hot Water (DHW) production and distribution, referring to the hospital requirements, pointing out the problems related to an energy efficient operation of this systems.

Content:

- Foreword
- 1. Space Heating
- 2. Space Cooling
- 3. Ventilation and HVAC
- 4. Domestic Hot Water

Booklet IV

Electrical System

This booklet aims to give practical assistance to the technical hospital staff, with the intent to reduce electricity cost, describing possibilities for an efficient and cost-saving use of electrical energy in hospitals.

The electricity supply system from the public grid to the individual users or groups of users within the hospital is examined, specially relating to electricity consumption.

Examples of practical cases are also reported.

Lighting is treated in a separate chapter.

Content:

- Foreword
- 1. Introduction
- 2. Electrical Energy Tariffs
- 3. Transformers
- 4. Energy Distribution Network and Reactive Load Compensation
- 5. Electricity Consumers for the Procurement of Thermal or Mechanical Energy
- 6. Lighting

Booklet V

Services

In this Booklet are considered the auxiliary systems which are generally present in hospitals, such as: hospital medical equipment, laundry, kitchen, sterilization.

A description of all systems considered is reported, with indication of amount of energy required in each case.

For each system, Energy Conservation Opportunities are included, both in the purchasing phase and during operation, in order to reduce the energy cost.

Content:

- Foreword
- 1. Hospital Medical Equipment
- 2. Laundry
- 3. Kitchen
- 4. Sterilization

Booklet VI

Building Envelope

This Booklet treats the problems related to the losses of energy occurring through the building envelope, which includes: walls, windows, roofs, floors, and fresh air intakes.

For hospital buildings, the following items have been considered: air infiltrations, walls, floors, roofs, windows.

Energy Conservation Opportunities are reported, with the aim to attain reductions in the energy required for the operation of HVAC systems in these buildings.

Content:

- Foreword
- 1. Air infiltration
- 2. Walls, floors and roofs
- 3. Windows

FOREWORD

This Booklet is meant to give practical assistance to the technical hospital staff to show how electricity costs can be reduced, while ensuring acceptable operation of the installation. It may inspire a systematic approach to such management projects. Although the share of electricity is only about 20 per cent of the total energy consumption of a hospital, it accounts for 1/3 of the total energy bill due to the specifically higher costs involved. (Values for average German hospitals)

This section describes possibilities for an efficient and cost saving use of electrical energy in hospitals. The electricity supply system from the public grid to the individual user or group of users is examined especially relating to electricity consumption. In systems, where steps to reduce the cost of electricity also affect the heat and cold consumption, only the electrical subsystem is analyzed.

Emergency power generation systems are not covered because they are preset for emergencies only and therefore do not constitute a separate item in the energy bill. In some countries, however, the operation of emergency generators for the reduction of peak loads is allowed and is part of the electrical system design.

Because of its special features, lighting is treated in a separate chapter in this Booklet. All other users of electricity either generating thermal or mechanical energy or supplying specific medical applications are covered in Chapter 5.

The objective of this Booklet is not to provide material for the design and planning of new facilities. However, it can give a facilities planner interesting background information.

CHAPTER 1. INTRODUCTION

1. Introduction

Figure 1.A shows a block diagram of the electrical system of a hospital and marks those points which are of interest for reducing the cost of electricity and/or energy savings.

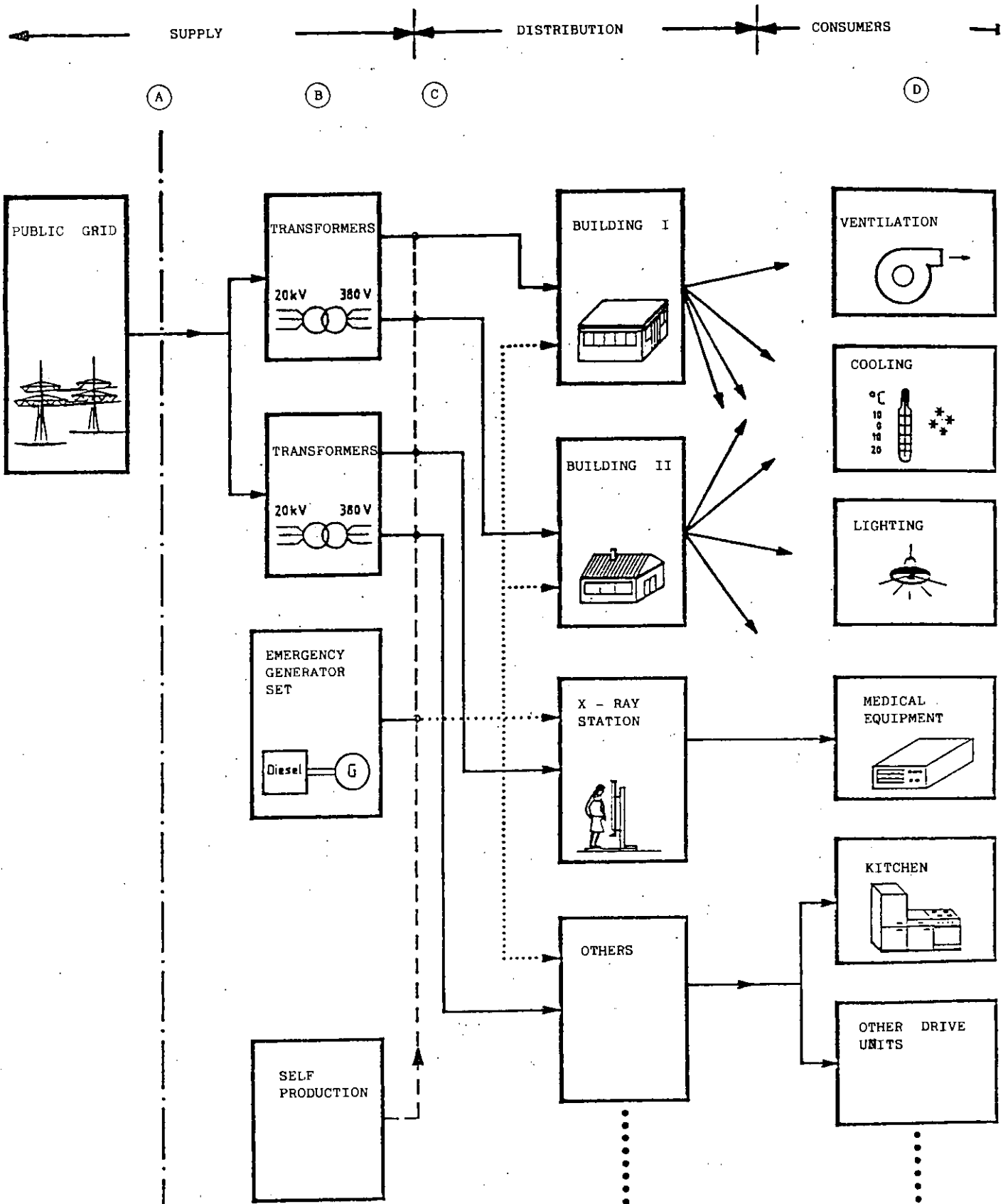

Fig. 1.A. - Block diagram of the electrical system with:

- (A) - metering point for energy billing (see Chapter 2)
- (B) - transformers (see Chapter 3)
- (C) - electrical distribution network (see Chapter 4)
- (D) - electricity consumers (see Chapters 5 & 6)

CHAPTER 2. ELECTRICAL ENERGY TARIFFS

2. Introduction

2.1 Description

2.1.1 General

The metering point between the supplier for electricity and the hospital is the first important element to consider concerning possible reduction of energy use and costs. The flow of energy passing through this point serves as a basis for the electricity bill. Load shifts inside the hospital do not affect the bill directly.

In general, hospitals are special customers and negotiate special contracts with the utilities. The rates are usually designed to encourage customers to make good use of the capacities of generating and distributing systems in the public supply. Specific fixed costs should be reduced through high utilization. The supplier guarantees to provide a certain electrical power and to deliver electrical energy within that power limit. The maximum peak load is measured with displaying, scribing or printing meters. The average energy costs depend on the tariff contracts and the consumption circumstances.

Details in the contracts may vary, but the principal content, however, is always quite similar. It consists of two main components, the demand charge and the kilowatt hour charge, while the kilowatt hour charge can be subdivided into steps depending on the level of consumption. Beside that there can also be a basic fee, not depending on the consumption at all.

2.1.2 The demand charge

This is based on the measurement of the total electrical energy used during a certain period of time, usually one quarter of an hour (sometimes one half hour). This measurement can be limited to certain times of the day, week or season and can consider either the active load (kW) or the apparent load (kVA).

The peak loads may influence the cost of electricity in various ways. What may be applied is:

- the maximum annual peak,
- the maximum monthly peak,
- the mean value comprising several peaks occurring during a certain period of time, such as e.g. the three highest monthly peaks.

The maximum load may also be taken into account by granting the user a permanent discount or a load factor related discount. The possibility of interruptable service in order to reach a favourable energy rate would not be appropriate for hospitals.

2.1.3 The kilowatt hour charge

This is based on the measured consumption of kilowatt hours, which is usually split into high and low rate periods depending on the hour of the day or night. Moreover, the price can be linked to the amount used. Prices may also depend on the day of the week or the season.

2.1.4 The contracted load and minimum consumption

As a contracted electrical load, a maximum value is taken that is usually not exceeded. A certain part of that, e.g. 50 - 80 % of this load is used for the quotation of the demand price even when it is not reached in reality. As a minimum charge for the power consumption in kWh, an annual duration time between 800 h and 1500 h/a of this contracted load can be taken into account. Exceeding the contracted load entails a drastic increase of costs and the possible adoption of a new threshold.

2.1.5 How to calculate electricity costs

The following formula shows the principal structure of a cost account with load price:

$$\text{cost} = E \cdot pr_E + P_{\text{Max}} \cdot pr_P$$

with:

E : electrical power consumption
pr_E : kilowatt hour charge
P_{Max} : maximum or peak load
pr_P : demand charge

The specific costs per kWh depend very much on the duration time T of the peak load respectively the load factor LF.

$$T = \frac{E}{P_{\text{Max}}} \quad \text{LF} = \frac{T}{t} = \frac{E}{P_{\text{Max}} \cdot t}$$

with t being the time frame, on which the calculation of the demand charge is based on, e.g.
 $t = 1 \text{ year} = 8\,760 \text{ h}$.

The load factor LF is calculated on the basis of the duration time of the account peak load in relation to the total accounting period which is usually one year. It is a measure of the evenness of power consumption. In theory, it can vary between a peak demand consumption in just 15 minutes *) and a constant consumption during the whole year **).

$$*) \quad \text{LF} = \frac{0.25 \text{ h}}{8\,760 \text{ h}} \quad (\text{minimum})$$

$$**) \quad \text{LF} = 1 \quad (\text{maximum})$$

The kilowatt hour charge pr_A in this example does not distinguish between high and low tariff. It is a mean value calculated as follows

$$\begin{aligned} pr_A &= \frac{0.05 \text{ \$/kWh} \cdot 8 \text{ h} + 0.07 \text{ \$/kWh} \cdot 16 \text{ h}}{24 \text{ h}} = \\ &= 0.063 \text{ \$/kWh} \end{aligned}$$

The following simplified calculation should give an example for a hospital with approx. 400 beds:

annual consumption E : 2 500 MWh/a
 maximum load P_{Max} : 460 kW

$$T = \frac{E}{P_{\text{Max}}} = 5\,435 \text{ h}$$

$$\text{LF} = \frac{E}{P_{\text{Max}} \cdot t} = 0.62 \quad (\text{with } t = 8\,760 \text{ h})$$

kilowatt hour charge pr_A : 0.063 \\$/kWh (peak/offpeak mean value)

demand charge pr_p : 150 \\$/kW

$$\begin{aligned}
\text{cost} &= E \cdot \text{pr}_E + P_{\text{Max}} \cdot \text{pr}_P = \\
&= 2\,500 \cdot 1\,000 \text{ kWh} \cdot 0.063 \text{ \$/kWh} + 460 \text{ kW} \cdot \\
&\quad \cdot 150 \text{ \$/kW} = \\
&= 157\,500 \text{ \$} + 69\,000 \text{ \$} = 226\,500 \text{ \$ per year} \\
&\quad \text{(kWh charge)} \quad \text{(demand charge)} \quad \text{(total charge)}
\end{aligned}$$

The average kilowatt hour price in this example results as 0.09 \$ per kWh.

A formula for the determination of the average kilowatt hour price derived from the above mentioned total cost calculation can be given as follows:

$$\begin{aligned}
\frac{\text{cost}}{E} &= \text{pr}_E + \frac{P_{\text{max}} \cdot \text{pr}_P}{E} \quad [\text{\$/kWh}] \\
&= \text{pr}_E + \text{pr}_P \cdot \frac{1}{T} = \\
&= \text{pr}_E + \text{pr}_P \cdot \frac{1}{\text{LF} \cdot 8\,760 \text{ h}}
\end{aligned}$$

Figure 2.1.A gives an example of the average kilowatt hour price as a function of the load factor. Based on the figures shown in figure 2.1.A the peak demand price is 150 \$ per kW and year.

If this peak occurs only once, the actual specific price is 600 \$/kWh, based on the 15-minute measuring intervals. In cutting the maximum by 1 kW each 150 \$ can be saved. (1 kW power for 15 minutes represents an energy consumption of 0.25 kWh. If it occurs only once, the specific kWh price is 4 x 150 \$, because 1/4 of a kWh costs 150 \$ extra.)

If the maximum demand can be cut by 10 % without reducing the total energy consumption, e.g. by shifting loads off peak, the savings can be considerably high.

As an example, the same values as before are used just the maximum demand is reduced to 414 kW. The total costs are then:

$$\begin{aligned}
\text{Cost} &= 2\,500\,000 \text{ \$} \cdot 0.063 \text{ \$/kWh} + 414 \text{ kW} \cdot 150 \text{ \$/kW} \\
&= 157\,500 \text{ \$} + 62\,100 \text{ \$} = 219\,600 \text{ \$}
\end{aligned}$$

The savings are 6 900 \$, which represent already the value of a smaller car.

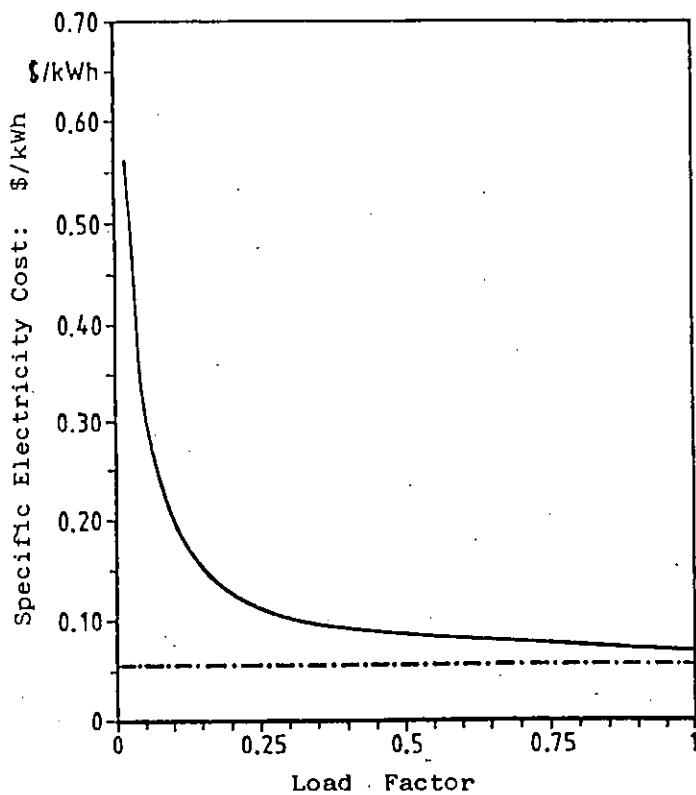

Price:

$pr_{HT} = 0.07$ \$/kWh

$pr_{NT} = 0.05$ \$/kWh

$pr_P = 150$ \$/kW

Peak Time: 6:00 to 22:00

Off-Peak Time: 22:00 to 6:00

$pr_E = 0.063$ \$/kWh

$pr_E =$ Average kWh charge

Figure 2.1.A. - Specific electricity costs as a function of the load factor

Figure 2.1.B shows schematically how electricity tariffs are derived from electricity generating costs in power plants. Specific cost reduction with higher consumption should not encourage higher electricity use. It should cause people to look for a balanced load cycle without high peaks and a high duration time of the peak load respectively a high load factor.

As an example of a typical daily load cycle and the corresponding yearly duration curve of a large German hospital is shown in figure 2.1.C.

(Formula as described before)

$$\begin{aligned} \frac{\text{Cost}}{E} &= pr_E + \frac{P_{\text{Max}} \cdot pr_P}{E} && [$/kWh] \\ &= pr_E + pr_P \cdot \frac{1}{T} \end{aligned}$$

The duration curve displays the change of price per kWh as a function of the yearly duration time T of the load.

These values are transferred to the load cycle to point out, that the price for electrical energy is drastically rising towards the peak load.

In figure 2.1.D, the same topic is shown as an explicit example for two different extreme load curves with the same total consumption. In addition to the decreased load demand, the lower prices during the night (NT) cause lower electricity costs.

2.1.6 Reactive energy account

Beside demand and kilowatt hour charge, a similar tariff system is usually set up for the reactive energy Q. The reactive energy flow in electrical systems is caused by either inductive or capacitive loads. Most of the installations in hospitals have inductive characteristics. One major group is the electrical asynchronous motors, which like transformers need magnetizing current in form of reactive power. Another group is the starters and the ballast in luminescent lamps.

Reactive energy, by definition, does not need active energy for its generation. However, the reactive current on the wires causes extra losses and also burdens the generator sets in the power plants. Therefore, a reactive energy flow should be compensated thereby becoming minimized. Costs may be calculated similar to active energy, or reactive energy

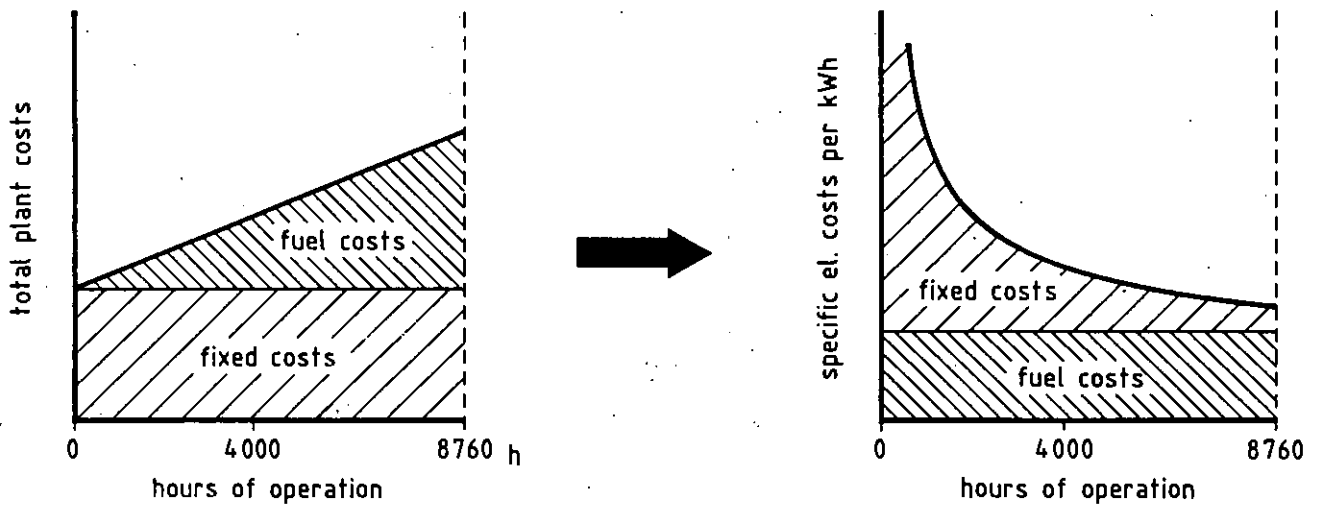

Fig. 2.1.B - Schematic: Basis for electricity costs at a generation plant

Average kilowatt hour charge $pr_E = 0.063 \text{ \$/kWh}$

Annual power demand charge $pr_p = 150 \text{ \$/kW}$

$$pr = \frac{\text{Cost}}{E} = pr_E + pr_p \cdot \frac{1}{T}$$

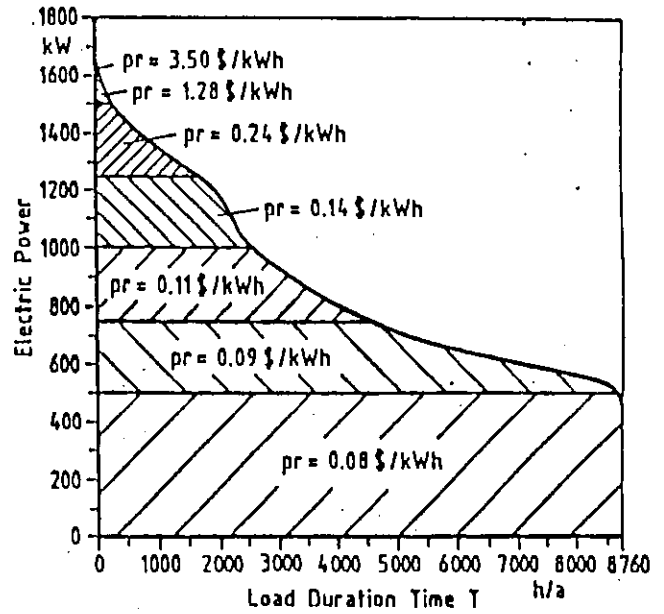
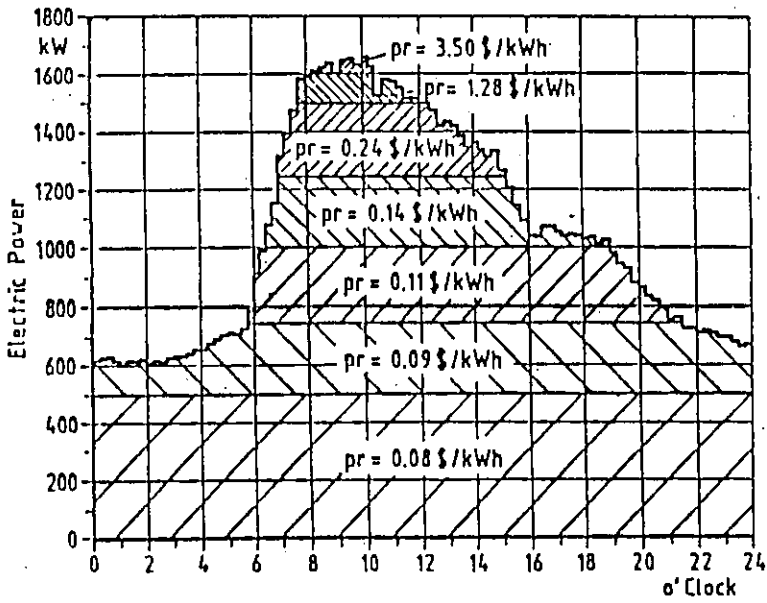
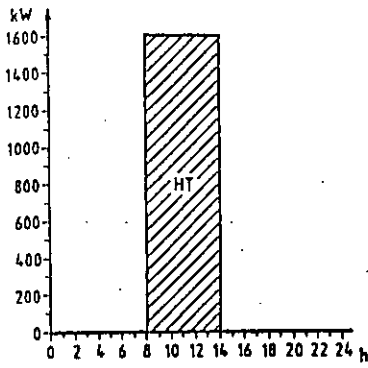

Figure 2.1.C - Typical daily load cycle and yearly duration curve of the load of a large German hospital



Price:

$$\begin{aligned} pr_{HT} &= 0.07 \text{ \$/kWh} \\ pr_{NT} &= 0.05 \text{ \$/kWh} \\ pr_P &= 150 \text{ \$/kW} \end{aligned}$$

Work:

$$(6 \cdot 365) \text{ h} \cdot 1\,600 \text{ kW} = 3\,504\,000 \text{ kWh}$$

kWh Charge:

$$3\,504\,000 \cdot 0.07 \text{ \$} = 245\,280 \text{ \$}$$

Peak Demand Charge:

$$1\,600 \text{ kW} \cdot 150 \text{ \$/kW} = 240\,000 \text{ \$}$$

$$\text{Total Cost} = 485\,280 \text{ \$}$$

Work:

$$(24 \cdot 365) \text{ h} \cdot 400 \text{ kW} = 3\,504\,000 \text{ kWh}$$

kWh Charge:

$$1\,168\,000 \cdot 0.05 \text{ \$} + 2\,336\,000 \cdot 0.07 \text{ \$} = 221\,920 \text{ \$}$$

Peak Demand Charge:

$$400 \text{ kW} \cdot 150 \text{ \$/kW} = 60\,000 \text{ \$}$$

$$\text{Total Cost} = 281\,920 \text{ \$}$$

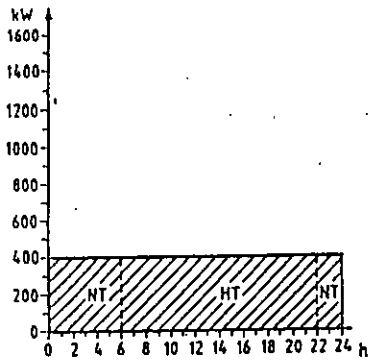

Figure 2.1.D. - Two extremes of load cycles with equal energy consumption

is normally not charged, which means that less than 48 per cent of the active energy is consumed as reactive energy ($\cos \phi \geq 0.9$).

Figure 2.1.E shows the connection between active and reactive current.

The $\cos \phi$ is a measure to determine the reactive power:

$$\cos \phi = \frac{\text{active current}}{\text{apparent current}}$$

$$\cos \phi = 1 \quad \text{only active power}$$

$$\cos \phi = 0 \quad \text{only reactive power}$$

2.2 Strategy

2.2.1 Objective and procedure

The objective of the project is to save energy costs without impairing the everyday operation and proper functioning of the hospital. Two approaches are conceivable, either separately or jointly:

- energy saving,
- taking advantage of the rate structure.

The topic of energy saving is treated in the chapters 3 - 6. This includes the reduction of losses and it is relevant for both reactive and active energy. Taking advantage of the tariff structure means:

- increase of the load factor
- reduction of the peak load
- shift consumption to times of low rates

For carrying out saving measures it is necessary, that the hospital technician in charge has a copy of the tariff contract in his hands. Costs can be cut in many cases simply by updating the parameters to the practical operation of the hospital. The contracted power for instance, in the beginning, is often determined on the basis of the installed power of the machinery under consideration of an estimated operating schedule. An adjustment to practical requirements is often overlooked. Therefore, the technician must also have the electricity bill at hand in order to have an overview over the situation. After studying the contract as well as the electricity bill, the person in charge should know the actual procedure of the cost calculation. When preset values, fixed in the contract, count towards the

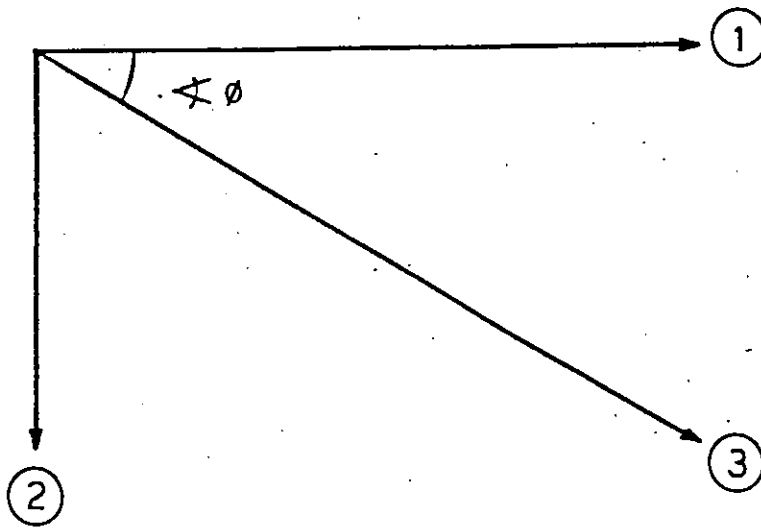

Figure 2.1.E.1 - Connection between active and reactive power

- 1 - active current
- 2 - reactive current
- 3 - apparent current

billing, it should be checked whether the contract conditions can be changed. If actual values of peak loads and power consumption are taken as a basis, the next step is to get a deeper understanding of the situation by measuring load cycles of the complete hospital and of single departments or consumer sections. This gives information about the major energy users and the consumers responsible for peak loads. Hospitals typically have relatively balanced load cycles.

Figure 2.2.A shows the daily mean consumption curve of a hospital on a workday. The time of utilization of the maximum equals about 15 h/d, the load factor related is 0.62. Major users in this case are ventilation drives, lighting and small consumers.

Figure 2.2.B shows the daily consumption in a pie chart. Load cycles for weekdays and weekends in each case are very uniform. One could even refer to typical load curves for weekdays and weekends. Figure 2.2.C shows the weekly load curve of various parts of a clinic and its total requirement for active and reactive energy. The steady and even curve indicates that only a few meters need to be available to assess the actual situation. Individual wards could also be measured one after the other if frequent peak loads were to be identified.

The electricity consumption of most of the users does not vary with the seasons. Here, however, the situation of the individual hospital has to be considered. If e.g. an extensive, electric driven cooling capacity is operated during summer, absolute peak loads appear during that season and are not compensated by the smaller demand for lighting compared to wintertime.

2.2.2 Measuring techniques

For the analysis of load cycles, an adequate set of measuring instruments is essential. The regular consumption pattern of individual users and the entire hospital allows measurement of one section after the other. In this way, the number of instruments can be limited.

The following equipment is recommended as a minimum:

- direct display power prongs that can be switched from active to reactive and/or apparent power, as well as to $\cos \phi$,
- current prongs of a suitable design and range that can be connected to power recorders and energy meters,

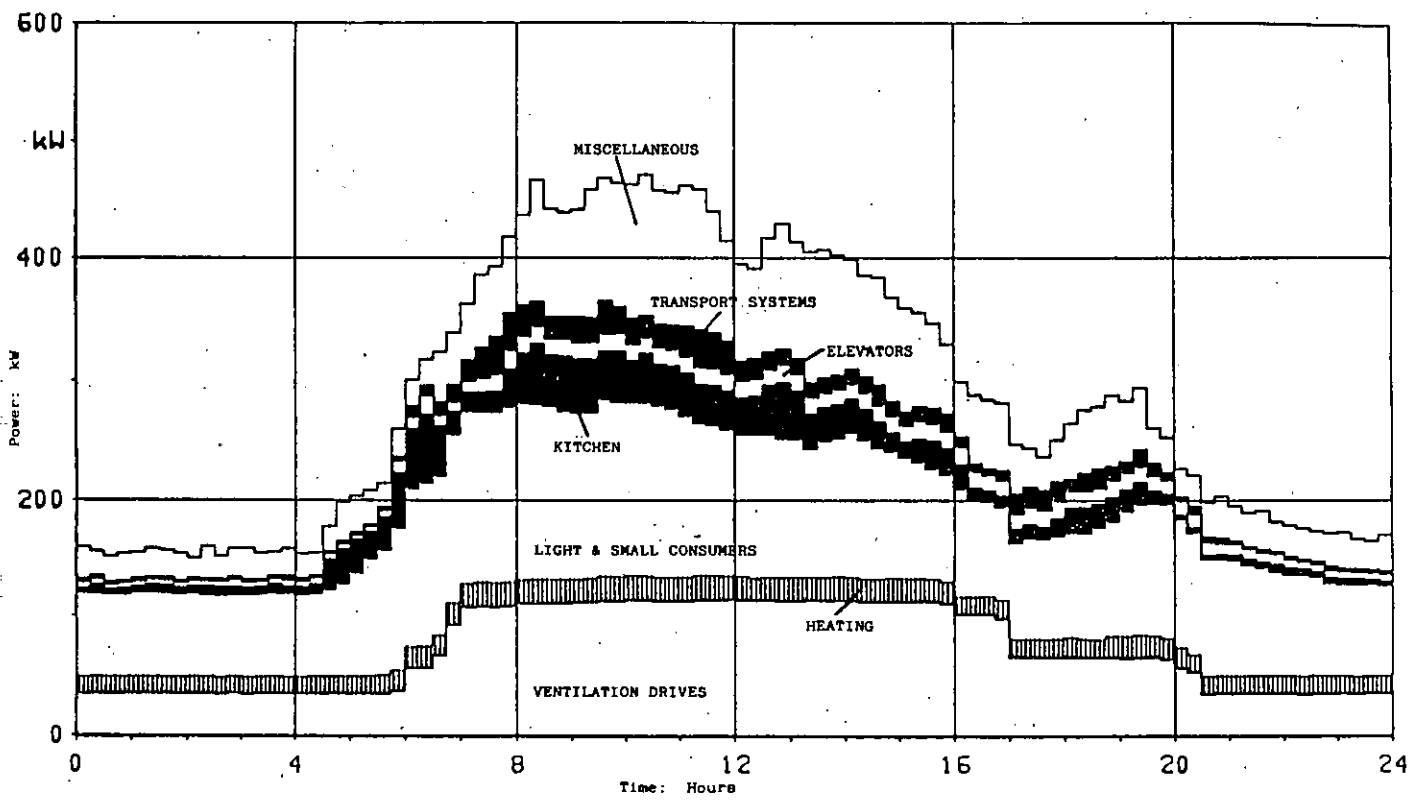

Fig. 2.2.A. - Average load cycle of the electricity consumption of Hospitals with 434 beds

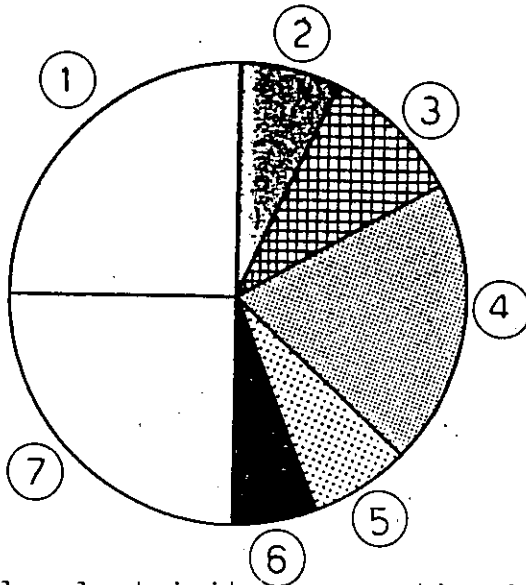

Figure 2.2.B - Daily electricity consumption broken down to main consumer sectors

1 - ventilation	25%
2 - kitchen	7%
3 - care facilities	10%
4 - miscellaneous	20%
5 - elevators, transport-systems	7%
6 - heating	6%
7 - lighting small consumers	25%

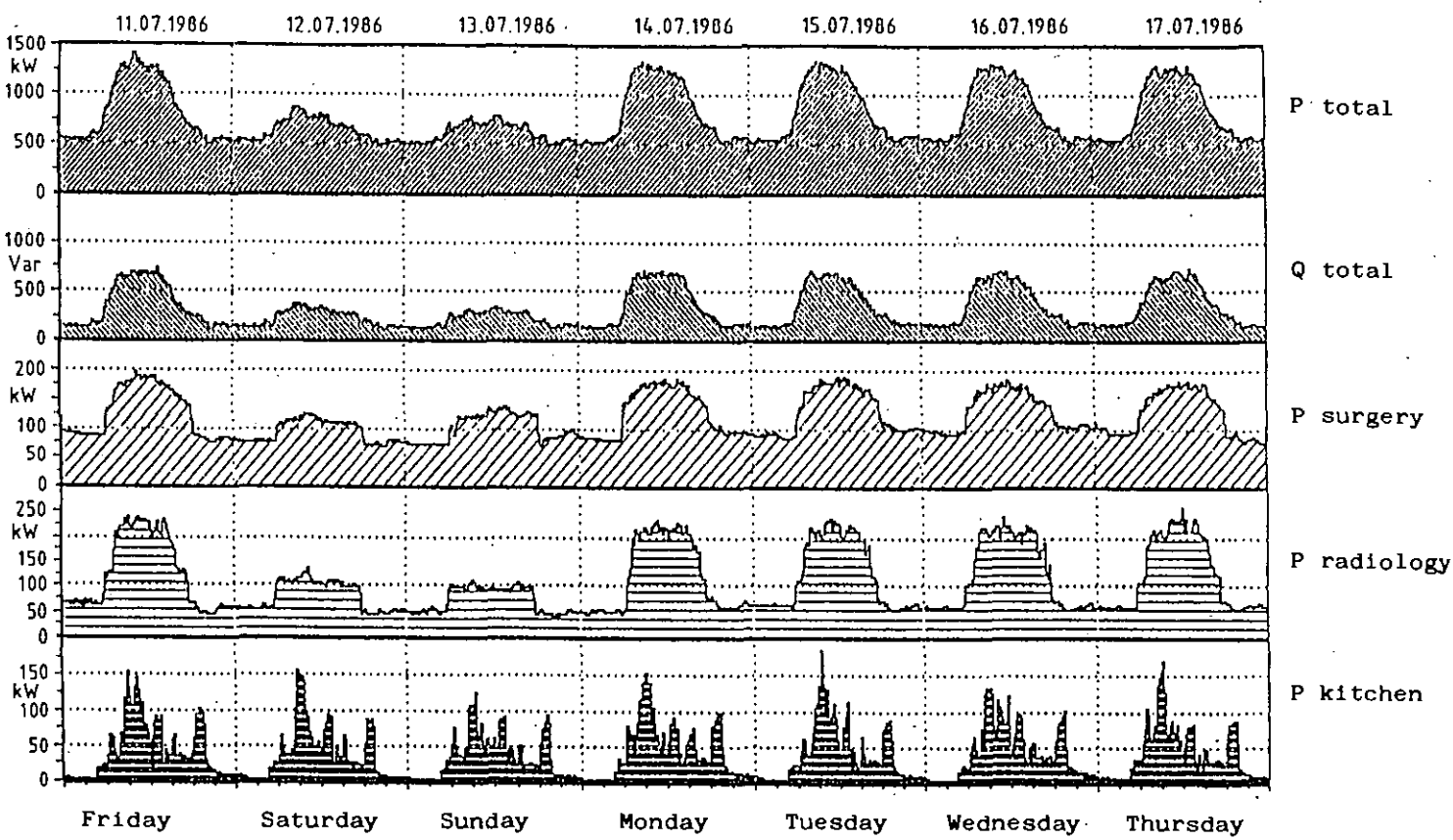

Fig. 2.2.C. - Weekly load curves of a large German Hospital (selection)

- three-phase power recorders to go with it, and
- meters or at least prepared measuring points to be connected with mobile equipment in every department for individual accounts.

Only in rare cases it is useful to fit ampere meters which only indicate the current utilization (apparent power of transformers), for instance.

As a matter of principle, measurements should be three-phase because experience has shown that additional users, which do not appear on plans or switching cabinets, are connected to single phases. Clear representations of the most important readings of part load curves and the total load are a must in successful electrical energy management.

2.3 How to save energy with minor changes

2.3.1 Updating of tariff parameters

If the contract is based on fixed values of contracted power and minimum consumption it must be checked to see whether these values can be changed to the advantage of the hospital. The result should be a lower electricity bill without even changing the consumption level. Electricity companies usually offer consulting services for this topic.

2.3.2 Avoiding of coincident peak loads

Cost can be cut mainly by avoiding extreme peak loads; peaks occurring with intermittently operating users are hard to anticipate, anyway. It would therefore seem obvious that ventilation drives, for instance, are slowed down at critical times and refrigeration or electrical boilers are switched off temporarily.

Judging suitable users for power reduction during times of peak loads depends very much on the organization of the particular hospital. For the technician, however, who knows his hospital it is usually possible to find consumers that can be influenced for these purposes. If possible, especially energy intensive operation of equipment should be shifted to times of low power consumption or low tariff times.

2.3.3 The hospital's internal cost distribution as an incentive for energy cost reduction

The easiest way for cost distribution is to calculate average cost per kWh by means of the energy bill and relate it to the department's consumption. Energy meters have to be installed in the departments first. This system, whatsoever, does not take expensive peak loads into account. In general,

it is very difficult to relate the contribution of different departments to peak loads. An exception are sections with a rather constant consumption, like ventilation systems or the supporting drives of the heating system.

An applicable way to take peak loads as well as plant and maintenance cost and cost for losses into account is the introduction of an additional factor (e.g. "f"). The following formula shows the context:

$$\text{cost} = E_{\text{tot}} \cdot \text{pr}_E \cdot (1 + f)$$

with:

E_{tot} total electricity consumption of the department
 pr_E average rate per kWh of the hospital
 f additional factor, usually between 0 and 0.5.

The factor f can be determined e.g. after the load factor of the single department and the time of the occurring maximum load, meaning the time congruency with the total maximum of the hospital. As those dependencies are not always easy to determine, the time distance between the absolute maximum of the hospital and the maximum of the single department can be used e.g. as shown in Fig. 2.3.A.

For the example in figure 2.3.A the maximum occurs at 11:00 o'clock and the time from 8:00 to 14:00 is considered as the "critical time" concerning a possible load peak. (180 minutes before and after the peak). A possible formula to get the factor f is then:

$$f = 0.5 - \frac{t_d}{2 \cdot 180 \text{ min}}$$

t_d : time difference in minutes of the single departments maximum to the total maximum

If a departments maximum is e.g. at 12:45, the distance to the time centre (11:00) is 105 minutes, the factor f then results as:

$$f = 0.5 - \frac{105 \text{ min}}{2 \cdot 180 \text{ min}} = 0.29$$

The formula is only to be used within the considered "critical time"!

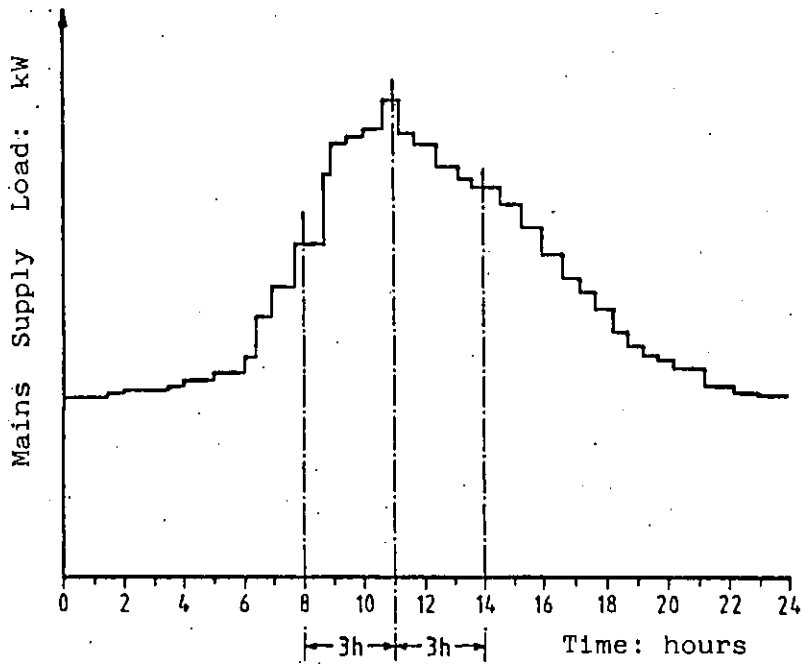

Figure 2.3.A. . . - Principal load cycle of a hospital

2.4 How to save energy by modifying installations

2.4.1 Maximum load control system

The installation of an automatic control system or the including of this function in a computerized building control system demands the consulting and planing by an engineering company. Nevertheless, some possibilities should be shown in this context to give the technician background information, because his feedback of knowledge is needed for the engineer.

Figure 2.4.A illustrates, in principle, three possibilities of reducing peak loads:

- a) switching off a consumer and bringing up the demand as soon as possible after the peak
- b) reduction of controllable items, e.g. the ventilation is reduced for a limited period
- c) load leveling for a consumer with compensation during low load times, e.g. a cooling system with an ice storage

For short term actions, not considering a longer load leveling, three different ways of handling can be distinguished:

Switching off

- without requiring compensation (e.g. ventilation)
- with a limited (in power) compensation (space cooling)
- with full compensation (refrigeration)

Figure 2.4.B gives a practical example, taken from the load curve in figure 2.2.C. One can see what makes up the peak of about 1 400 kW between 10:00 and 10:30 o'clock on 11th July 1986. Small peaks occur in the dishwashing section, in the utilities area and in several surgery departments, because they all start working again at the same time after their morning break. As the medical departments can usually not be influenced to change habits, special machinery in the utilities area and the dishwashing section should be gradually switched on again. To stagger the morning breaks would have a positive influence on the load cycle too.

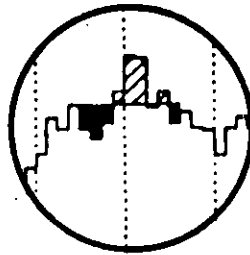
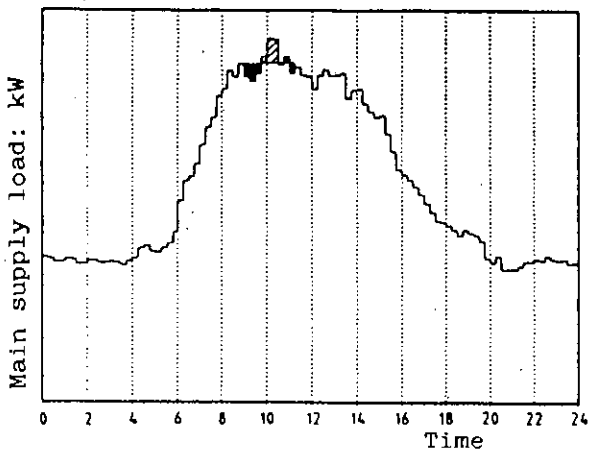

Switching off a consumer and bringing up the demand as soon as possible after the peak

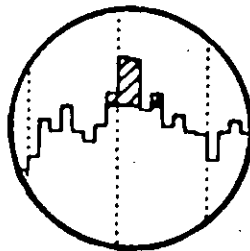
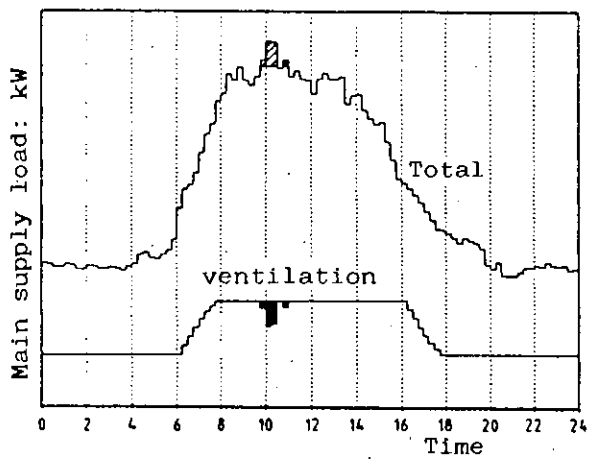

Reduction of a controllable items, e.g. the ventilation is reduced for a limited period

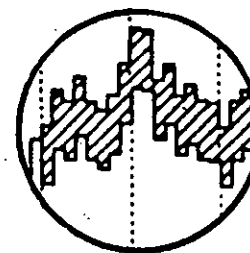
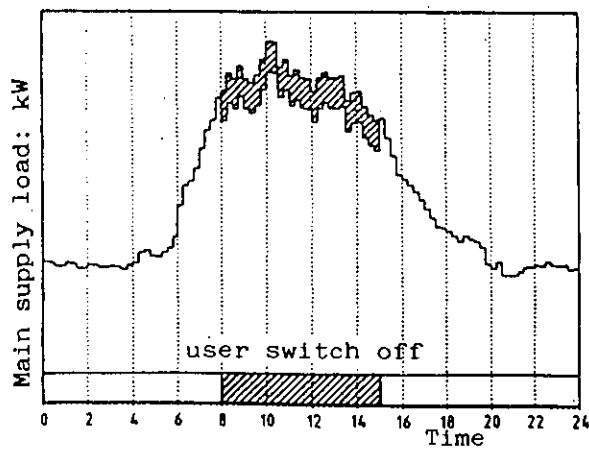

Load levelling for a consumer with compensation during the load times, e.g. a cooling system with an ice storage

Figure 2.4.A. - Possibilities for reducing peaks

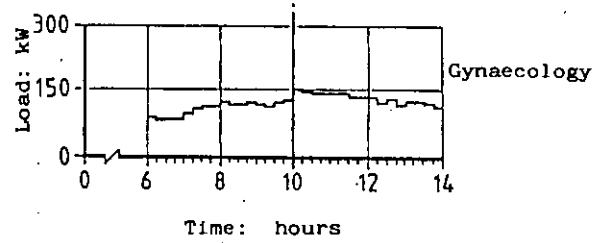
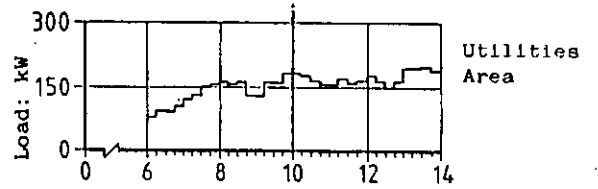
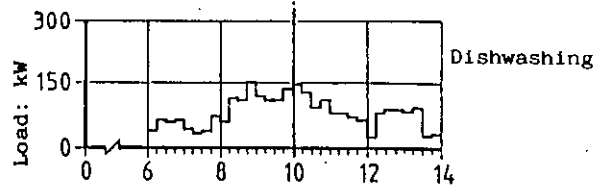
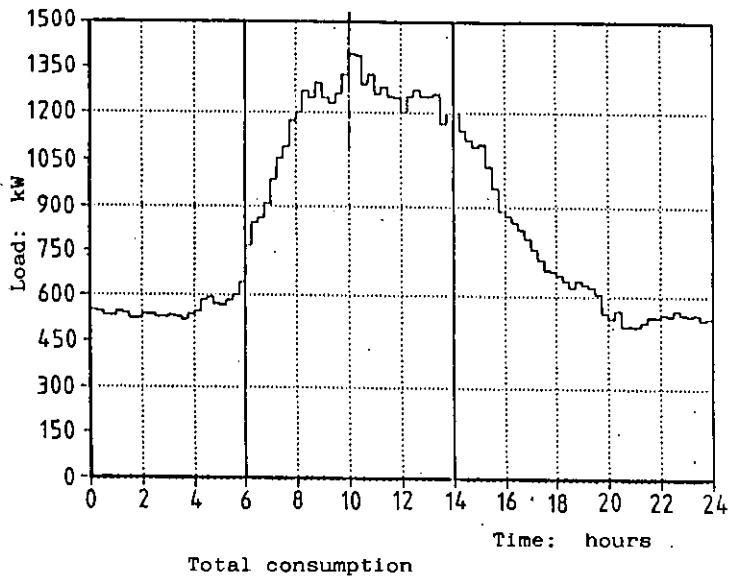

Fig. 2.4.B. - Summation of individual peaks

JUST FOR INFORMATION:

Three different principal methods are used for computerized peak load optimization with energy compensation:

- the free load method

It predicts, using the current load, what the energy consumption will be until the end of the measuring period. The prognosis of the consumption is compared with a preset maximum value. With additional criteria of free switchable or controllable machinery in operation, the computer can decide necessary power reduction.

- the base load method

It is based on the fact that a certain basic consumption, lower than the preset maximum, is always necessary. Within that two values, the computer calculates at what time during the measuring period it is needed to reduce the load.

- the average load method

It is quite similar to the free load method, it just takes the average power from the beginning of the measuring period instead of the momentary power.

Which method should be used should be decided together with the consulting engineer. It must be remarked here, however, that due to the various important and life-related tasks in a hospital the capacity for reducing peak loads is limited compared to many industrial utilities.

In all three methods, the computer senses loads exceeding a certain limit and automatically disconnects e.g. a ventilator or a cooling unit over a short period of time e.g. 5 minutes.

Because of that short time, temperatures in this case are nearly not affected at all.

CHAPTER 3. TRANSFORMERS

3. Introduction

3.1 Description

Transformers are installed in the distribution network between power input at medium or high voltage levels and the users. Transformers are used to transform the supply voltage to low voltage level. For operating theatres and special care wards, such as intensive care wards, a 1:1 converter is often used for potential separation.

Figure 3.1.A shows a principal sketch of a transformer including primary (index 1) and secondary (index 2) voltage and current.

Besides the consumption of reactive power for magnetizing, a transformer has constant active losses in the iron and copper losses in the windings, depending on the current.

To calculate actual losses for specific loads, two values of a transformer have to be determined:

P_{LO} idling losses in kW

P_{LCuN} copper losses at nominal power

The values of P_{LO} and P_{LCuN} can be either obtained from the transformer data sheet or they can be calculated using the following approximations for standard transformers:

$$P_{LO} \approx 0.010 \cdot S_N^{0.75} \quad (\text{kW})$$

$$P_{LCuN} \approx 0.052 \cdot S_N^{0.75} \quad (\text{kW})$$

with:

S_N - nominal apparent power of the transformer
in kVA

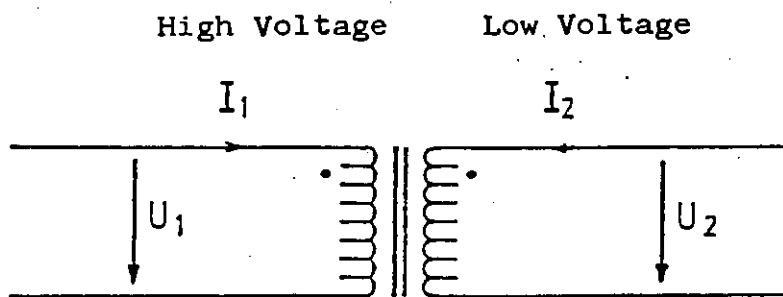

Figure 3.1.A. - Principal sketch of a transformer

Primary: index 1

Secondary: index 2

The following formula shows the calculation of transformer losses:

$$P_L = P_{LO} + \left[\frac{I_2}{I_{2N}} \right]^2 \cdot P_{LCuN}$$

with:

- P_L - total losses of the transformer in kW
- P_{LO} - idling losses in kW
- P_{LCuN} - copper losses at nominal power
- I_{2N} - secondary current at nominal power (see nominal data)
- I_2 - actual secondary current

3.2 Strategy

Beside a proper maintenance of the equipment, the reduction of transformer losses is an appropriate way to save energy costs. Especially in large hospitals, several transformers are operated to serve the various units. In low voltage installations, various bus bars can be linked with each other; they are meant to assume a stand-by function if one transformer fails. Very often, however, they are not split in these cases and the transformers are operated in parallel. This results in increased losses especially during low load periods. Through a suitable operation schedule, e.g. controlled by timers or by an automatic building control system, these losses can be minimized.

The first step, however, is to collect the data of all transformers installed in the hospital. If data sheets are not available, idling losses and copper losses at nominal power can be calculated as shown in the proceeding § 3.1.

This information is needed together with actual measuring values to investigate successfully an optimized operation. Sometimes an inactivation of units is not possible out of different reasons. To avoid a disturbing influence on other stations, X-ray equipment - because of their very high short term peaks - are supplied by a special transformer. Facts like this have to be taken into consideration when setting up a schedule.

The qualification of transformers and power switches, however, has to be suitable for more frequent switching.

Whenever several transformers of equal nominal power are operated in parallel, a rough figure is, that it is best to operate each unit between one third and two thirds of its nominal power.

3.3 How to save energy with minor changes

3.3.1 Reduction of transformer capacity in low load periods

When several parallel transformers supply a hospital, losses can be reduced by switching off units during low load hours. As load curves are usually very similar from day to day, a schedule can be set up, e.g. using a typical night load. The curve in Figure 2.2:A shows e.g. a power P between 180 and 200 kW. Either by measuring or by calculating the secondary current with the formula:

$$I_2 = 3 \cdot \frac{1}{U_2 \cdot \cos \phi} \quad (\text{for a 3 phase system})$$

with:

U_2 - voltage between phase and ground

the actual losses can be determined with the method shown in § 3.1.

By checking the losses with different transformer configurations, the best way of operation can be found.

The following approach can be taken when transformers supply separate groups of users in order to avoid the impact of shock loads from one area to another. Transformers can be switched to operate in parallel, when one user that causes short term peak loads is off duty, in which case the capacity of the transformers in operation can be optimized.

Another possibility is to use one of the transformers which are running anyway to supply one part of the hospital in parallel when this part is off-peak. In this case, for instance, the transformer supplying an X-ray centre during the day can be switched off during the night, and power required for lighting and other users is available from the transformer installed for a care facility. The steps explained above can also be included in a "schedule".

3.3.2 Optimization of the parallel operation of several transformers

If several transformer units of equal nominal power are available and can be operated in parallel, the performance can be optimized as follows:

Due to the constant, load-independent idling losses, it can be advisable to switch off transformer units during low load periods, although copper losses rise quadratic with the load current.

Figure 3.3.A shows the losses of a single or of two, three and four transformers of equal nominal power operated in parallel as a function of the secondary power. The interrupted line shows the optimal operation concerning total losses.

The following equations show how, by comparing copper and idling losses, the optimum operation for units of equal nominal power can be found.

The load value S_u constitutes the limit, at which a reduction of the transformer capacity by one unit (from n to $(n-1)$) appears meaningful.

$$S_u = a \cdot S_N \quad (\text{kVA})$$

$$a = \sqrt{n \cdot (n-1) \cdot \frac{P_{LO}}{P_{LCuN}}}$$

with:

S_u limit value for capacity reduction
 S_N rated capacity of one transformer in kVA
 P_{LO}, P_{LCuN} idling losses and copper losses at nominal power in kW

A possible procedure is shown in the following example:

A hospital is provided with several transformers of 400 kVA rated apparent power each.

Losses can be approximated to (§ 3.1):

$$\begin{aligned} P_{LO} &\approx 0.9 \text{ kW} \\ P_{LCuN} &\approx 4.6 \text{ kW} \end{aligned}$$

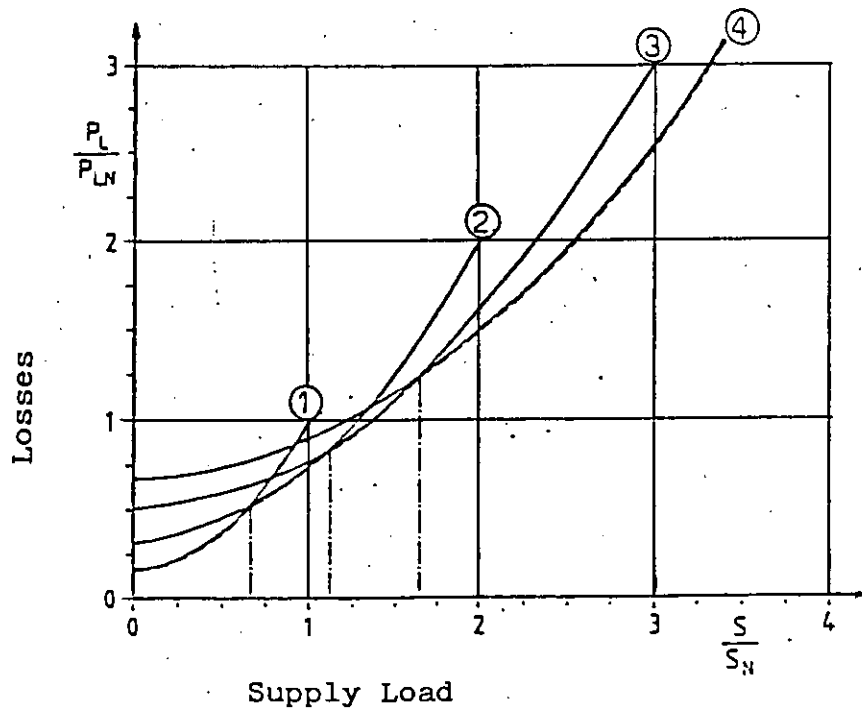

Figure 3.3.A. - Losses of one or more transformers operated in parallel depending on the load

S_N : Nominal apparent power of one transformer unit

P_{LN} : Losses of one unit when operating at nominal power

①②③④ : Number of units in parallel operation

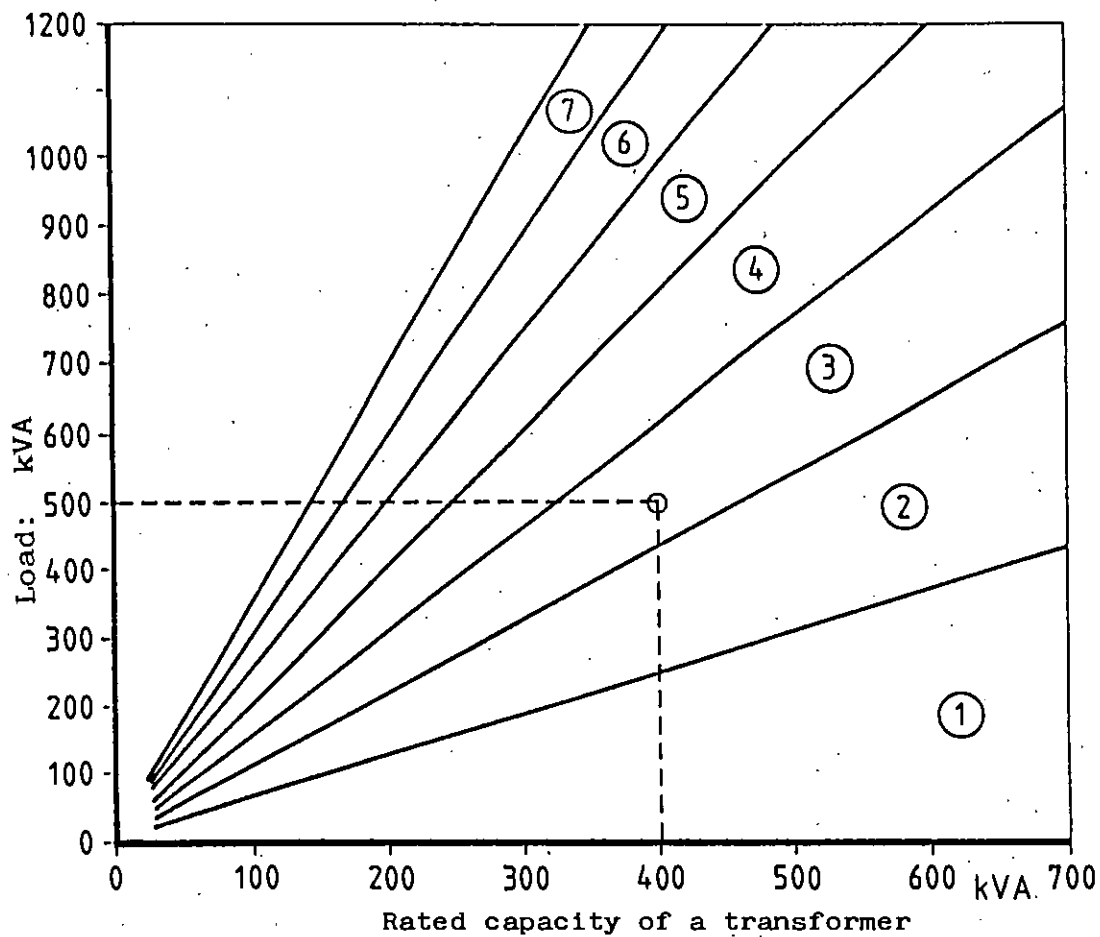

Figure 3.3.B. - Optimum number of transformer units of equal nominal power operated in parallel depending on the load.

The load, when e.g. three units in operation should be switched down to two would be:

$$S_u \approx 440 \text{ kVA} \quad \text{with} \quad a \approx 1.1$$

The diagram in Figure 3.3.B shows the number of transformers of same rated capacity (abscissa) that should be operated at respective capacity loads (ordinate). If e.g. several transformers are available with an apparent output of 400 kVA, as is shown on the diagram, then the loss will be at its lowest if three transformers are operated in parallel at a main load of 500 kVA.

To set up an operation schedule, that can be controlled automatically, a daily load curve can be divided into sections as shown in figure 3.3.C.

Again, the limits for 400 kVA transformers, taken from Figure 3.3.B are used. The intersecting points mark the point in time at which a clock can switch one unit on or off. The continuous supply is ensured because two transformers are on permanently, and their rated capacity could cover even the peak load, if necessary. Transformers can also be operated in overload for short periods of time, e.g. 110 % for 30 minutes. If an average load cycle is based for that method, this mode of operation produces the least losses.

Based on the evenness of the total load curve this schedule can be divided into various load ranges; using the diagram shown in Figure 2.2.C the operating times of various power stages can then be determined. In the simplest form, a distinction can be made between day and night operation.

For the example in Figure 3.3.C, it would be advisable to switch from 2 to 3 units at 6:00, to 4 units at 7:30, back to 3 units at 15:00 and to 2 units at 17:00.

Within the whole topic of operating transformers following a preset schedule, it has to be considered that power switches have a limited lifetime depending on the frequency of switching. Also the windings of the transformers are strongly stressed during switching due to magnetic forces. Transformers with mechanically supported windings should therefore always be used.

The reduced lifetime of the equipment through higher switching frequency must be included in an economical evaluation.

Generally speaking, one could say that the switching frequency should not be more than once or twice a day,

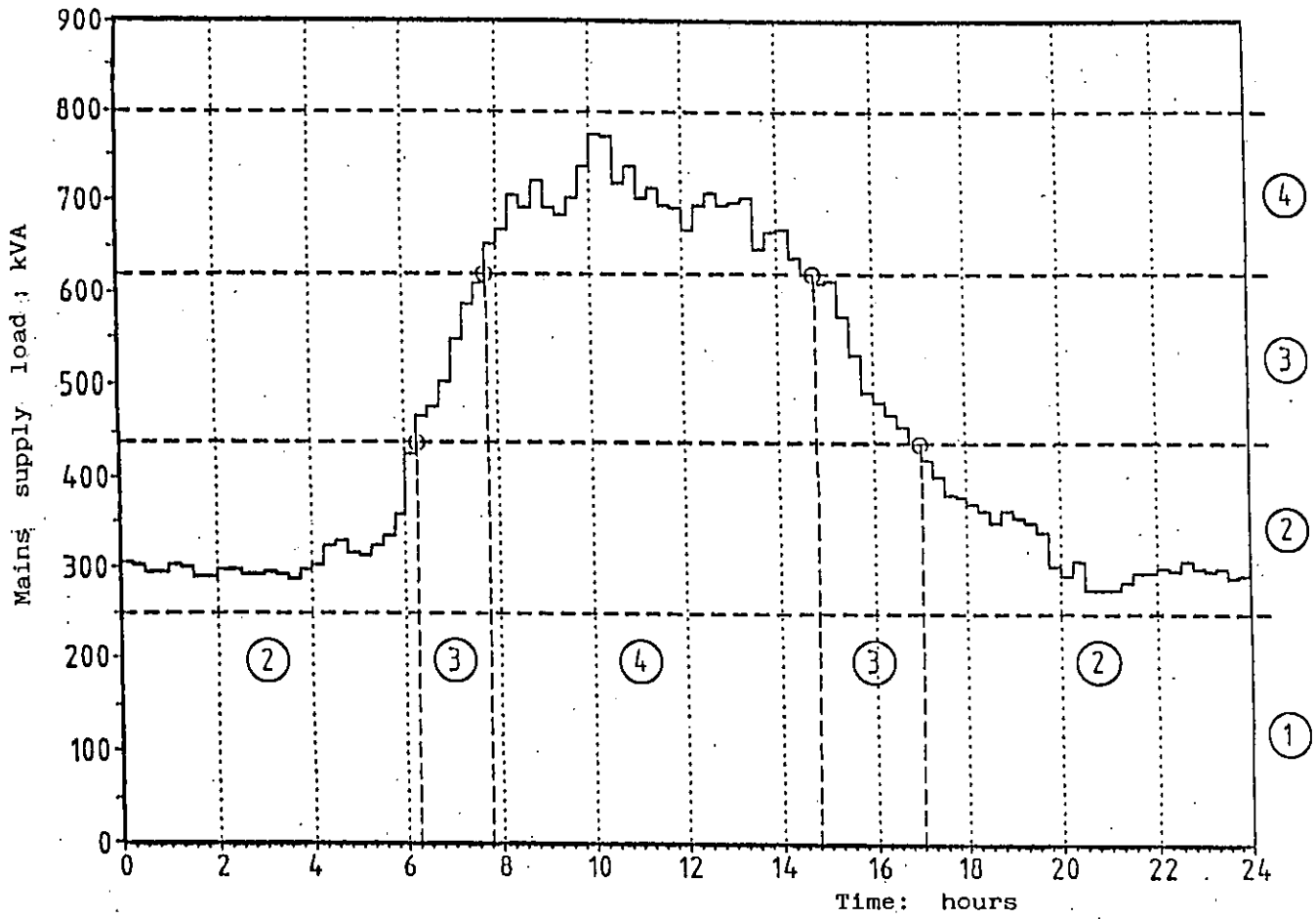

Figure 3.3.C. - Example of a transformer schedule

1 2 3 4 - number of transformers in use with same performance of 400 kVA each

depending on the type of equipment. For information, it would be best to contact the manufacturer.

3.4 How to save energy by modifying installations

3.4.1 Replacing old transformer units

If old transformers are still in operation, it could be possible, that they contain sheet iron packages, where the plates are still rolled in a hot state. Modern transformers with cold rolled iron consume of only about 50 % of the idle losses of the older units.

Decisions, however, have to be made after an economical calculation.

When transformers have to be replaced because of technical reasons, care should be taken to choose types with low losses and mechanically supported windings, that provide a high switching rate capability.

3.4.2 Installation of additional transformer units

If a hospital is supplied from only one transformer - a second back up unit with the same rated power is essential beside that - it can be advisable to install an additional smaller unit for low load periods during night-time. Also here, economical balances should be made in advance.

CHAPTER 4. ENERGY DISTRIBUTION NETWORK AND REACTIVE LOAD COMPENSATION

4. Introduction

4.1 Description

The energy distribution network covers the power system from the transformers and the supply point to the different users. It is a very wide and often intricate network supplying various users including vital medical machinery. In older hospitals, plans of the electrical network are often not updated or not available at all. For an organized energy management, however, a complete set of plans is very important.

Figure 4.1.A illustrates the main routing in a clinic, that has been enlarged and converted over a period of several decades. In this case no correct plans were available as it is often the case in old installations. Therefore the switching diagram shown has been reconstructed based on numerous local investigations and switching trials. This diagram will also serve as a basis for the new control room. Such a plan is extremely helpful for identifying and defining the power situation also supported by individual measurements.

The dimensioning of the internal distribution network is often not done with enough care, although it has a big importance for the rational electricity supply of the hospitals. Possible high voltage drops on transmissions can have a negative influence on the active and reactive power consumption of consumers. Losses within distribution networks can reach 4 - 8 % of the total energy consumption.

4.2 Strategy

For a successful energy saving program on the distribution network, an updated switching diagram of the hospital should be available. With the help of this diagram, a systematic program to determine cable losses and to check the reactive load consumption of users under typical operational conditions can be carried out. Concerning the $\cos \phi$, the first step is to optimize single users, especially those with high reactive power consumption. Electric asynchronous motors, e.g. have a nearly constant reactive power consumption depending on the load. Oversized motors, therefore, cause unnecessary high reactive load (see Chapter 5).

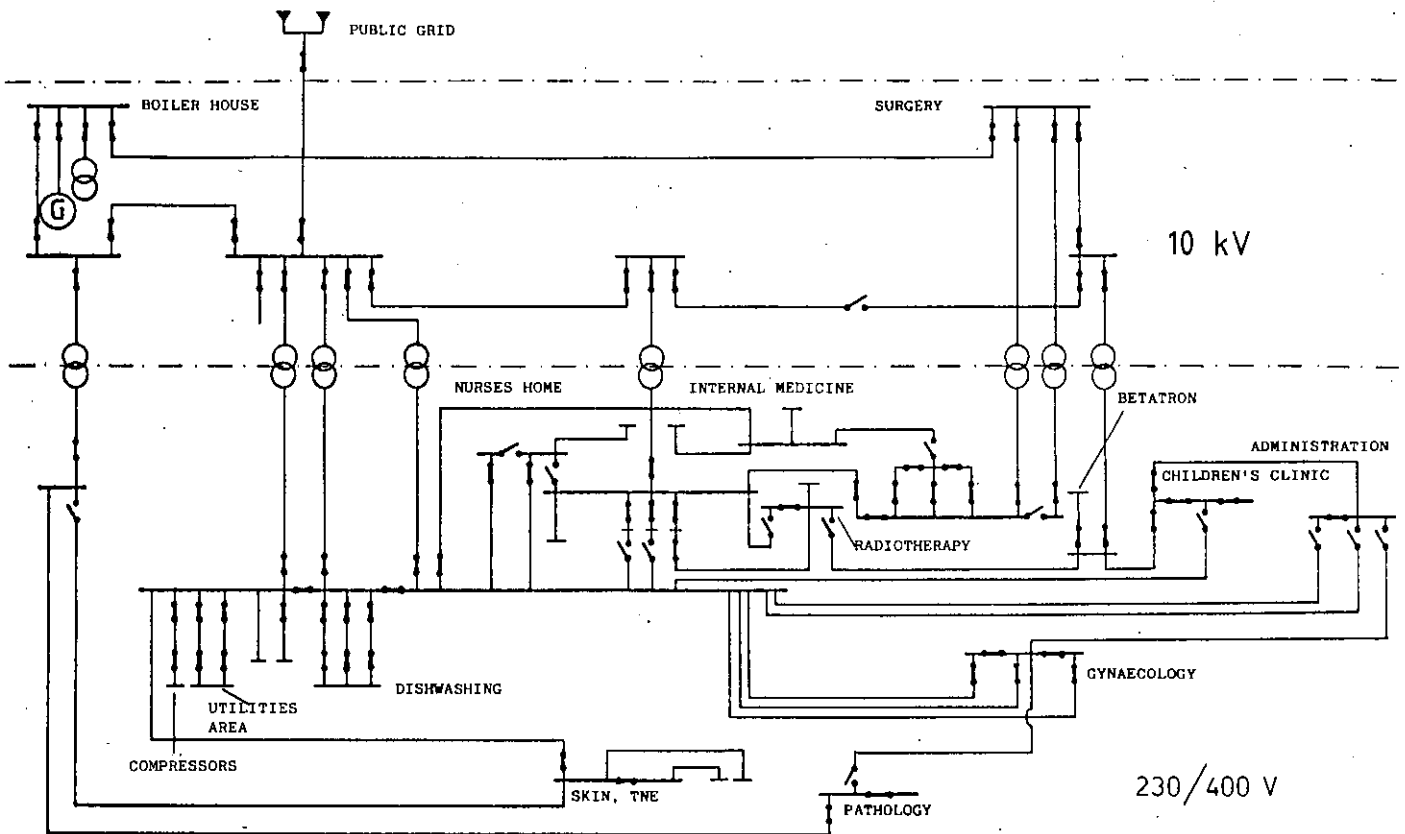

Figure 4.1.a - Distribution of electricity in a hospital with approx. 1,200 beds

By comparing the cost of avoidable losses with investments, that have to be made, cost effective measures can be decided (example in 4.3).

Even when new transmission lines are to be installed, a cost comparison between the increase of the investment through using a thicker cable and reduced energy costs should always be made.

4.3 How to save energy with minor and/or major changes

The examples in this section can be applied to either the section of minor or the section of major changes, depending on the range of the installed compensation load or the constructional measures that have to be undertaken for installing new cables.

4.3.1 Replacing cables through more cost efficient ones

By comparing the cost reduction through reduced losses with investment to be made for replacing cables it can be found out, whether it is economical to substitute old installations or to also just install a parallel cable. A way to evaluate the cost of losses in cables is described here.

Tables stating cable characteristics only show current limits, up to which a steady operation is possible without destruction of the material. As the cost for losses is considerably high, the economically best cable diameters are usually higher than the ones, that are necessary from a thermal point of view. An influence on that context exists from the average energy costs and the utilization time of the cable. Based on a constant voltage, the cost minimum goes to thicker cables when a higher utilization is occurring.

Cable losses are calculated as follows:

$$P_{LC} = I_2^2 \cdot R_C \cdot 0.001 \text{ (kW per phase)}$$

with:

P_{LC}	cable losses in kW
I_2	apparent current in amperes (A)
R_C	cable resistance in Ohms (Ω)

The resistance of a copper cable R_C is:

$$R_C = 0.0178 \cdot \frac{L}{A} \quad \Omega$$

with:

L cable's length in meters
A cable's cross section in mm²

To evaluate the costs of losses, e.g. during one day, the following formula can be used as an approximation for a more or less constant load:

$$E_L = (\bar{I}_2)^2 \cdot t \cdot R_C \cdot 0.001 \text{ (kWh per phase)}$$

with:

\bar{I}_2 average current during the operation in A
 E_L daily energy losses in kWh
t time of operation during the day in hours
 R_C cable resistance in Ω

For exact determination, one can use integrating meters, that measure

$$I^2 \cdot t \text{ in kA}^2\text{h.}$$

The above formula changes as follows:

$$E_L = (I^2 t) \cdot R_C \text{ (kWh per phase)}$$

Care has to be taken, that all phases of the system, usually 3, are considered.

By multiplying the daily losses with the average energy costs per kWh, the costs of losses can be evaluated.

Figure 4.3.A shows principally the transmission costs as a function of the cable cross section. The costs for losses reduce and the costs for the cable rise with thicker diameters.

When a rising amount of energy has to be transmitted, the costs for losses rise and the most economical cross section moves to higher values even when the maximum current is not reached.

4.3.2 Installation of decentral compensation capacitors

As the cable losses depend on the square value of the current, a reduction is possible through minimizing reactive current on the cables, which means decentral single or group compensation. By a clever choice of capacitor locations

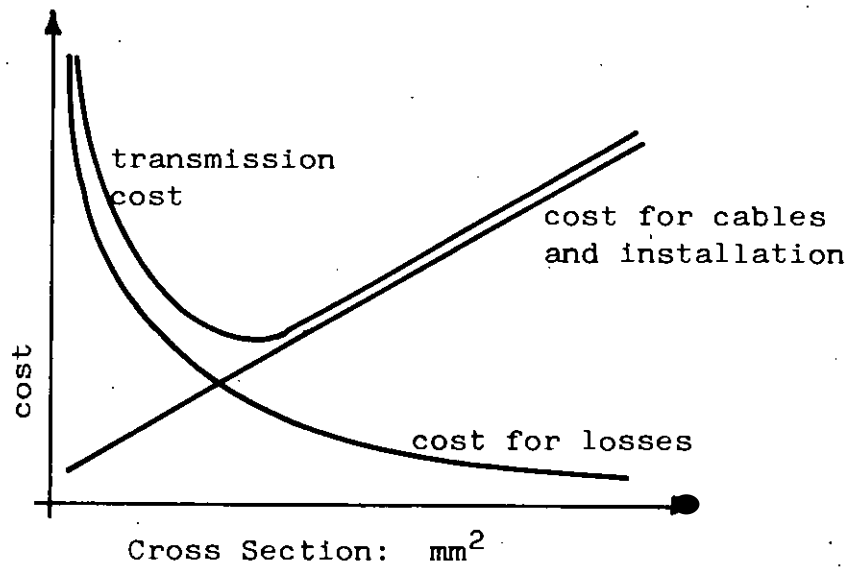

Figure 4.3.A. - Principal transmission cost depending on the cable cross section

remarkable advantages can be obtained. While a central compensation only saves costs for blind load, decentral compensation saves additional cable losses. The following formula shows how losses increase with decreasing $\cos \phi$:

$$P_{LC} = P_{LCW} \cdot \frac{1}{(\cos \phi)^2}$$

with:

P_{LC} cable losses in kW
 P_{LCW} cable losses with only active load
 ($\cos \phi = 1$) in kW

With a $\cos \phi$ of 0.5 e.g. cable losses are 4 times as high as with only active load ($\cos \phi = 1$). (Figure 4.3.B)

A determined compensation avoids high voltage drops and very often the necessity of thicker cables. The necessary capacitor load can be easily calculated as follows:

$$P_C = P_W \cdot (\tan \phi_1 - \tan \phi_2)$$

with:

P_C rated reactive power of the capacitor
 in kVAR
 P_W active power involved in kW
 ϕ_1 phase angle before compensation
 ϕ_2 phase angle after compensation

The following practical example shows a possible way to proceed:

A 3-phase copper cable with a cross section of 120 mm^2 per phase and a length of 210 m is supplying a group of asynchronous motors. During 10 hours of each day 660 kWh and 1320 kVARh are transmitted. The average $\cos \phi$ is only 0.45. The average current is 225 A. That means that the cable is not fully utilized from a thermal point of view. Related to the average value, power deviations of $\pm 20\%$ occur. Over all, $510 \text{ kA}^2\text{h}$ are transmitted per phase. The conductor resistance is:

$$R_C = 0.0178 \frac{\Omega \cdot \text{mm}^2}{\text{m}} \cdot \frac{210 \text{ m}}{120 \text{ mm}^2} = 0.0312 \Omega$$

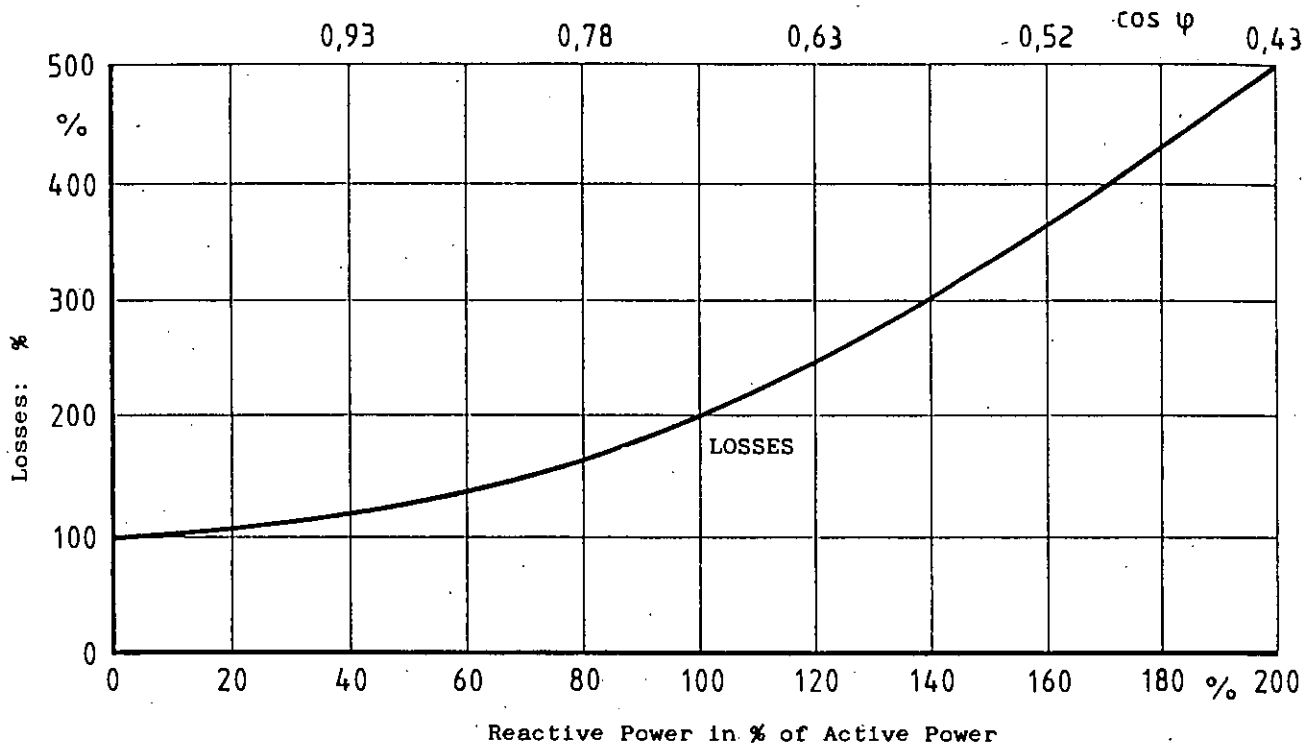

Fig. 4.3.B. - Dependence of cable losses from the cos φ

with the formula

$$E_L = 3 \cdot I^2 t \cdot R_C \cdot 10^{-3} \text{ (kWh) total}$$

daily losses of 48 kWh result.

With an average price of 0.07 \$/kWh and 300 days operation per year, 1 008 \$/a costs for losses can be determined.

Beside that, the reactive energy above 50 % of the active energy has to be paid with 0.015 \$/kVARh. Additional costs of

$$(1\ 320 \text{ kVARh/d} - 660 \text{ kWh/d} \cdot 0.5) \cdot 300 \text{ d/a} \cdot 0.015 \text{ $/kWh}$$
$$= 4\ 455 \text{ $/a}$$

can be calculated.

With an installation of a capacitor with 75 kVAR at the end of the cable the $I^2 t$ value is only 182 kA^2h per phase and, the daily losses can be reduced to 17 kWh. The yearly costs of losses are reduced to 357 \$. Besides that, only 570 kVARh reactive energy per day have to be transmitted.

The resulting cost for losses is now:

$$17 \text{ kWh/d} \cdot 0.07 \text{ $/kWh} \cdot 300 \text{ d} + (570 \text{ kVARh/d} +$$
$$- 660 \text{ kWh/d} \cdot 0.5) \cdot 300 \text{ d/a} \cdot 0.015 \text{ $/kVARh} =$$
$$= 1\ 437 \text{ $/a}$$

This means, that a yearly amount of 4 026 \$ can be saved in total. With investment costs for the capacitor of about 2 600 \$, which includes an automatic control system for the capacitor load in 6 steps with 12.5 kVAR each, the payback period is only 8 months. By placing the compensation central at the beginning of the transmission line, the payback period rises to 9.6 months. A 75 kVAR capacitor alone, that could be installed just parallel to the motors, costs only about 1 000 \$.

This example displays that investments like this usually pay back in a very short period of time, depending on the utilization of the system.

CHAPTER 5. ELECTRICITY CONSUMERS FOR THE PROCUREMENT OF THERMAL OR MECHANICAL ENERGY

5. Introduction

5.1 Description

5.1.1 General

This section discusses individual users of electrical energy with the concentration on those items where experience shows that energy use can be influenced in terms of operating mode and/or configuration in order to reduce energy consumption and cost. Lighting will be covered in Chapter 6. Special problems arising in an all-electric hospital are not discussed here, although many points of this Booklet can also be applied in these hospitals. The large number of electric powered medical machines and other small appliances are not mentioned here, because they cannot or must not be influenced by energy saving measures. The remaining possibilities for this group of users will occur in Booklet V, "Services".

The most important users in the sense of an efficient use of energy can be subdivided into two groups:

- electrical drives and
- electrical heaters

5.1.2 Electrical drives

Electric motors of various designs and capacities are among the main consumers of electrical energy in hospitals. The high requirements to be met in terms of air quality and the arrangements of buildings with large inner zones have led to a situation where large areas in hospitals have to be air-conditioned or at least ventilated. Ventilators used for this purpose are normally driven by asynchronous motors ranging from 100 W to far more than 10 kW, depending on the required air volume rates. Modes of operation are a function of differing requirements and may vary between 24 hours of full-load operation and intermittent operation, depending on the type of process the ventilation is linked with. Accordingly, they can be operated in part load during non-critical periods; this means that they can be influenced in terms of power consumption, e.g. by means of a monitoring system (see also Booklets II and III).

Other drives are found in pumps used for circulating heating water; such pumps are normally working continuously.

Numerous transport systems for persons and material are also driven by electrically powered machines. These are mainly lifts, material transport systems and battery-driven electric cars. At a clinic with 1 200 beds, studied in the Federal Republic of Germany, there were e.g. 96 elevators.

Air-conditioning systems and refrigeration chambers are usually linked to electric compressor refrigerators. In Booklet II, a separate chapter is devoted to cold generation, nevertheless, a few hints are given here on how electricity bills can be cut. Compressed air systems supplied by central compressors are also major users of electricity. Compressed air is used in medical appliances, in pneumatic heater controls and control valves, as well as in pneumatic tube conveyors.

Another user group comprises drives used in service areas, such as dishwashers and mixers in kitchens and large spin driers in laundries. It is difficult to provide a detailed list of all appliances because equipment may vary from hospital to hospital, apart from the fact that the technician at the hospital can sometimes hardly influence the operation of these machines in order to achieve a better energy management (see also Booklet V).

5.1.3 Electrical heaters

Electrical heat generation is used wherever it is impossible or very expensive to provide connection with a central heating network. This applies to both decentralized hot water and steam generation. Although the specific cost of electricity is higher it can be economical to use electrical heaters if that helps avoid high availability losses and line losses in fuel-heated central systems. Electric heating is also used in dishwashers and in steam-heated systems for post heating because it is easier to control the temperature electrically. In kitchens, both steam heated and electric pots and pans are used; most of the grills and griddles are electric.

5.2 Strategy

The objective is to achieve a reduction of electricity cost respectively total energy cost through influencing the operational mode as well as the hardware configuration of energy systems. It is important to restrict these interventions to actions that do not upset the whole hospital system. However, the possibilities for energy savings are limited compared to an industrial plant, because of the complex structure of a hospital, combined with demands of high operating safety, hygiene and the need to provide optimum recuperating conditions for patients. Nevertheless, a large number of energy saving measures can

be carried out and extreme peak loads can be avoided. This is associated directly with the situation described in § 2.3 in this Booklet. A systematic approach is recommended:

First of all, **any defects in the systems should be repaired**. This does not only apply to electrical equipment but also to the systems supplying the hospital service.

For instance, leaking in compressed air pipes should be repaired or missing insulation in a refrigeration system should be replaced. **The operation of the systems must be adjusted to practical use and needs of the hospital.**

Suitable basis for this approach can be the analysis of load cycles of departments or single users by power recorders. In this way individual peak loads and their causes can be identified. It also includes the checking and adjusting of air flow rates and operating times.

The personnel must be taught to think "energy-responsible" and, e.g. not to run machines during peak load hours whenever possible, or to avoid unnecessary operation of equipment.

Consumption can also be reduced by **replacing electrical installations** through more energy efficient ones or by additional energy saving equipment such as e.g. a comprehensive monitoring system or electronic devices to reduce losses.

At this point it should be mentioned, however, that energy saving measures concerning heat are often electricity-intensive. This means that overall energy costs are cut while electricity consumption rises. An example is the operation of decentralized electric steam generators in cooking facilities during weekends, when this entails at the same time the possibility to shut down the central steam supply. The electric peak load reached in the course of the week should not be exceeded. Another example is the use of electrical heat pumps. When changing the system it is important that no new and expensive peak loads are created because that may offset the benefits completely. In most cases, it will be necessary to introduce defined off-periods.

5.3 How to save energy with minor changes

In this context, a catalogue of measures is given, that contains trouble shooting and maintenance and changes in the mode of operation. The only additional installations needed are clocks, timers or time-controlled step switches. Measures entailing the necessity of installing other appliances are covered in § 5.4.

5.3.1 Trouble shooting and maintenance

- Appliances, thermostats, clocks, etc. must be checked on a regular basis for function and adjustment.
- Hot water boilers and steam generators must be cleaned regularly.
- Fan motors must be checked for function, V-belts, if torn, must be replaced.
- Filters in ventilation systems must be cleaned or replaced regularly, because excessive pressure losses increase electricity consumption.
- The compressed air system must be checked to eliminate any leaks.
- Any missing insulation on refrigeration systems and coolant pipes must be replaced. (Special care must be taken in the prevention of losses at wall break throughs and armatures.)

5.3.2 Changes in the modes of operation

Typical load curves can be derived from the characteristics of consumption. One of the main electricity consumers of a modern hospital is the sector of ventilation drives and pumps in the heating system. The load is usually very even over longer periods of time.

Figure 5.3.A shows qualitatively two load curves applying to this group of users. Both characteristics were found during measuring programs in hospitals. By determined part-load operation and by switching off ventilators out of utilization of service areas, consumption decreases overproportionally, because the air intake is reduced during lower outdoor temperatures at night-time.

The following catalogue gives some examples of possible measures, which, however depend on the individual conditions in the hospital.

- Appliances should be switched off whenever possible, for instance during breaks.
- Idling losses should be minimized.
- Rotary converters of lifts should also be switched off after a short delay, when the lift is not working.
- Ventilation in service or therapeutic areas should be switched off or at least reduced, when personnel in these areas is not on duty.
- Ventilation should anyhow always be operated on part load when possible.
- Air volume should be adjusted to the requirements.

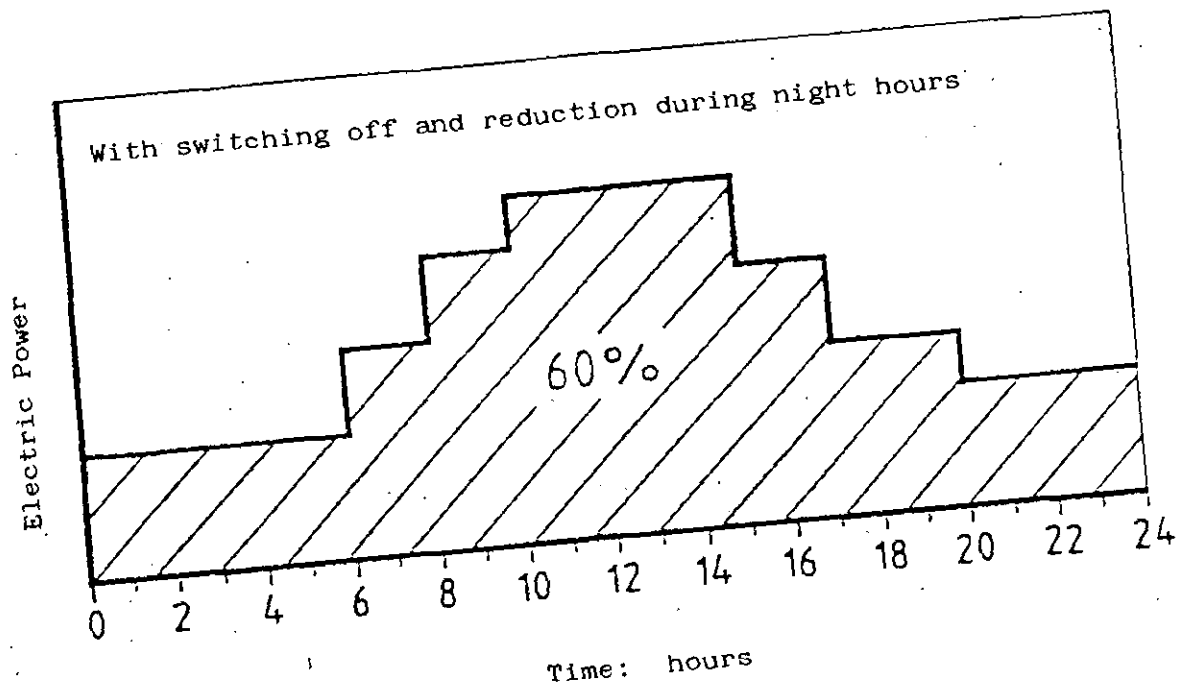
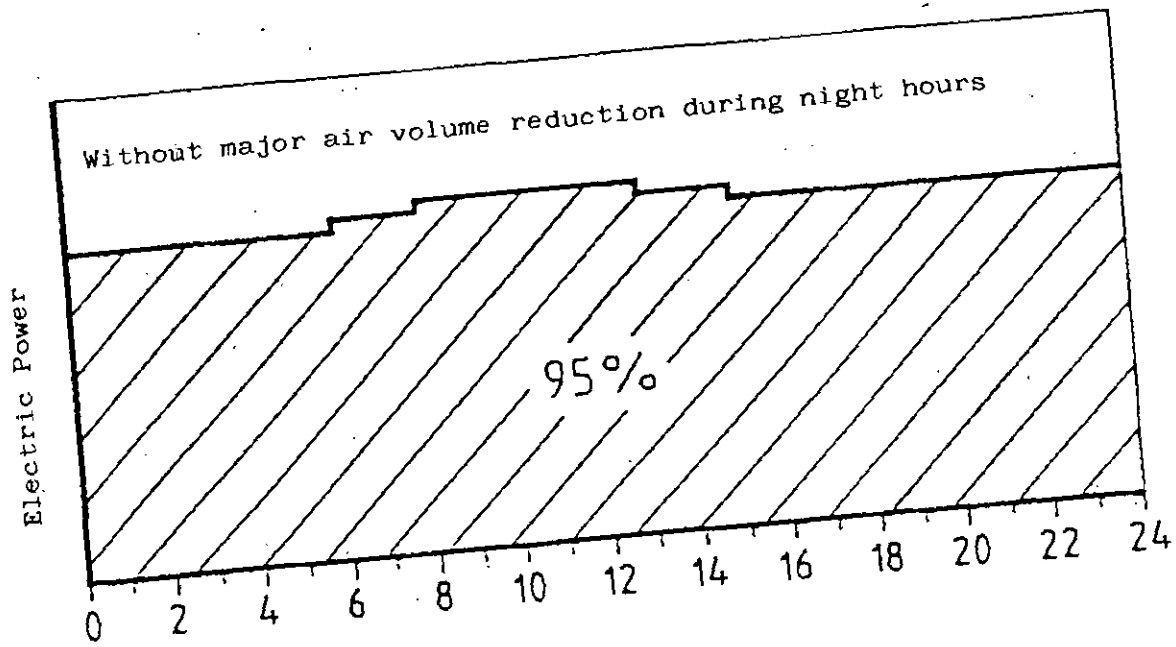

Fig. 5.3.A. - Electricity consumed by blowers and fans

- Kitchen staff should be instructed to give preference to steam cookers if there is a choice between electric cookers at peak times.
- Battery chargers, especially those of electric transporter batteries, should only be operated during off peak hours.

5.4 How to save energy with modifying installations

Today, a great variety of so called energy saving appliances are on the market. When new equipment is bought, the specific energy consumption of the device should be taken into consideration. This section, however, concentrates on some points that seem to be most interesting for a hospital application. Having the advice of a consulting engineer is recommendable most of the times.

5.4.1 Installation of cold storage

Through the installation of a storage unit for either cold water or ice, refrigeration can be shifted to off-peak hours. The increased energy consumption because of storage losses can be usually compensated by lower electricity prices during the night (see also Booklet III).

5.4.2 Decentral installation of control facilities for ventilation systems

Control facilities for ventilation and air conditioning systems should be installed at the location of utilization, not just in the mechanical rooms. The staff, in that case, can increase the ventilation rate when needed, e.g. in the operating theatre before an operation. The necessity of using full-load air rates when the full surgery lighting system is on is also used as a control parameter in practice.

5.4.3 Optimize drive motors for ventilations and other purposes

Electrical asynchronous motors (ASM) are the main source for mechanical energy in hospitals. It can be found very often, that they are oversized and therefore operated with low efficiency and a low $\cos \phi$, because the reactive energy consumption is nearly not depending on the load (compensation is discussed in Chapter 4). The easiest way to reduce the nominal power of an ASM in some cases is the switch over from delta to star connection, which means an electrical reduction to 1/3 of the power. Constant operation up to about 35 % of the nominal power is possible. It must be taken into account that the values stated on the electric

motor specifications show the mechanical output of the unit and not the electrical input, which is likely to be higher.

In some cases, it can also be economically better to replace the whole motor. New types of energy efficient motors should be used and sized in a way that they can be operated with maximum efficiency.

5.4.4 Installation of electronic control units for electric motors

The development of such appliances are very much connected to the development of microprocessors and power-semiconductors. Several new types are on the market, with which the operation of ASM can be controlled and optimized.

Only one possible choice will be given here, it is an electronic motor starter manufactured by Siemens. It provides a smooth start up by starting with only 40 % of the nominal voltage and slowly increasing it to 100 %. This rise can be timed in 8 steps from 0.5 to 60 seconds. The start-current can be limited in the range of 250 to 450 % of the nominal current (the usual start current of an ASM can be up to 8 - 10 times as high as the nominal current). When operating in part load, the control device reduces the supply voltage, the current reduces and the $\cos \phi$ rises. By providing the user with the necessary momentum, the ASM is always operated with an optimum load factor.

Such electronic devices can help in reducing costs for active and reactive energy. The amount of energy savings, however, depends on the type of motor, the time of utilization and the load of the connected appliance. Because of the smoother operation, an increase in lifetime of the ASM has to be considered.

Figure 5.4.A shows the integration of the starter.

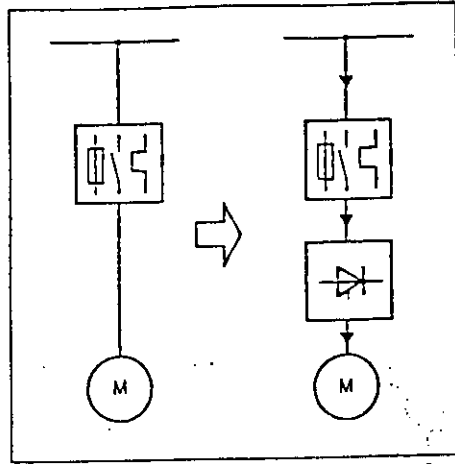

Figure 5.4.A. - Integration of electronic starter devices

CHAPTER 6. LIGHTING

6. Introduction

6.1 Description

6.1.1 General

Artificial lighting is, with ventilation, one of the biggest electricity consumers in hospitals. It is often difficult to give accurate data on what part lighting plays in the overall electricity consumption, but we can expect it to be around 30 % for general hospitals and 20 % for long term care facilities and nursing homes. As electricity is a costly, high grade energy, a remarkably high amount of energy cost can be saved by a careful carrying out of energy conservation measures in this field.

The installations concerned by this chapter include the luminous sources, the luminaries, the auxiliaries (ballast and starters), the circuitry from the lighting board and the control system.

The lighting system in a hospital comprises daylighting and all artificial lighting including emergency lighting. Built-in lighting of specialized medical equipment is excluded here.

The availability of emergency lighting during electrical outages is especially important because of the critical needs of hospital patients. Outdoors, lighting is used to create a more attractive environment as well as for security.

The important points to be seen and discussed when looking for energy cost reductions in lighting are:

- sources of light (lamps)
- ballasts and starters
- luminaries
- control systems and lighting design
- maintenance.

6.1.2 Lamps

There are two principal families of lamps:

Incandescent lamps and discharge lamps.

- In incandescent lamps, light is produced by a filament heated to incandescence by the passage of the electric current. The filament is enclosed in a glass bulb which is either evacuated or more usually filled with an inert gas at low pressure. A tungsten filament is used in most incandescent lamps which are often called tungsten lamps. When filled with a gas containing some proportion of halogen like iodine or bromine, they are called tungsten halogen lamps or iodine lamps.
- In the large family of discharge lamps, light is produced directly or indirectly by the electric discharge through a metallic vapour, a rare gas or a mixture of both. The lamp usually is coated by fluorescent material.

Depending of the metallic vapour and the inner pressure of the mixture of gases, we distinguish in this family:

- metal vapour lamps (mercury or sodium vapour; high pressure)
- (metal) halide lamps: high pressure, metallic vapour with addition of halides of thallium, indium and sodium
- sodium lamps: high or low pressure discharge lamps with sodium vapour
- fluorescent lamps: low pressure mercury discharge lamps

Unlike incandescent lamps, the discharge lamps need auxiliaries called ballasts so they can be started.

The progress in this field is very rapid and lamps with new properties appear regularly on the market. A careful examination of the data given by the manufacturer is therefore necessary to effectuate the best choice between lamps, regarding the application and needs.

The properties of sources (lamps) which are important for the user are:

- The luminous flux (light output) of the lamp (lm=lumen):

It is obvious that to obtain a given illuminance (illumination level) in an area, the greater the luminous flux per lamp is, the fewer are the lamps needed.

But, apart from other criteria of choice, there is a limitation in the maximum value of luminous flux: for lamps installed at low or moderate height, luminous fluxes that are too high can induce too high illuminance and/or inhomogeneity, glare, etc.

- The luminous efficiency of the lamp (lm/W):

This is the ratio of the luminous flux emitted by the lamp to the power consumed by it. It is expressed in lumen/Watt (lm/W).

- The colour of the lamp described by its colour temperature (K):

The colour temperature expresses the degree of warmth associated with the source colour: lamps with low colour temperature have a warm colour appearance and those with high colour temperature have a cool colour appearance. So, if we want the patients to "look nice", we will prefer lamps with low colour temperature.

- The colour rendering properties of the emitted light described by the CRI (colour rendering index) of the lamp:

The higher the colour rendering index is, the better are the colour rendering properties of the lamp.

It is important to have a perfect perception of colour in many hospital locations:

- where medical examinations or operations take place,
- where chemical or biological analysis are performed,
- in pharmaceutical laboratories and
- in some degree in kitchens and restaurants.

- The time necessary to obtain the full light output:

This point is in close relation with control systems. The starting time is the time delay necessary for a lamp to give its full light output when switched ON.

Some lamps immediately give their full light output; some need a special ballast to do it; others require a certain delay after having been turned off, before they can be switched ON again.

It is obvious that lamps with delayed starting time cannot be employed in areas where immediate lighting is necessary: medical areas, pharmaceutical or drugs storage, patient rooms, etc...

- life cycle
- cost (including auxiliaries)

6.1.3 Ballasts and starters

All discharge lamps need **auxiliary equipment** to be started and operated. This auxiliary equipment will stabilize the electric voltage at the electrodes of the lamp. It always comprises a small transformer and, depending on the type of lamp, possibly a starter or capacitor.

For mercury low-pressure lamps (fluo tubes), different types of ballasts can be used: normally, rapid start or electronic types are applied (this last type reduces ballast losses by eliminating core and coil assembly and offers greater flexibility for control).

6.1.4 Luminaries

Lamps are installed in luminaries of various characteristics. The function of luminaries are:

- holding lamps and eventually part or all of the auxiliaries;
- protecting them against dust, water, shocks and excess rise of temperature;
- diffusing and/or directing the light emitted by the lamp(s) in different directions;
- participating to the creation of a pleasant environment from an aesthetic point of view;
- protection of the user against high voltage.

6.1.5 Control systems

For lighting control equipment, we can define the following categories:

- the lighting can be **switched** or **dimmed**: when the electrical circuit is switched ON or OFF, the illumination level varies abruptly from zero to full value or inversely; when dimmed, the illumination level varies continuously.

- the control can be **local** or **central** depending if the control device (switch or dimmer) is placed near the electrical circuit and the lighted zone or not. Obviously "CENTRAL" control comprises many devices acting on separate electrical circuits.
- the control can be **manual** or **automatic**, depending if it requires some active manipulation to effect control operation or not. An automatic control system acts on electrical circuits through orders given by clocks, photocells, presence indicators.

The most basic control is a simple **on/off-switch**. In many cases a large number of fixtures are controlled from a single switch or circuit breaker.

Time clocks, or time switches have been in use for many years, especially for outdoor applications. New developments include programmable time clocks which allow the user to schedule lighting for a week at a time, and astronomic clocks which cause the control to adjust automatically for changing hours of light or darkness during the year.

Photocell controls are particularly useful outdoors, and are applied indoors to control lighting near windows. The most basic version switches lighting on and off depending on the amount of daylight. They can be combined with an additional timer.

Incandescent lamps (with or without halogens) can be regulated by dimmers from maximum value to zero; discharge lamps cannot be dimmed except special mercury low-pressure lamps which can be dimmed from maximum value to near 30 % with special auxiliaries. But it seems that in the U.S.A., energy-saving solid-state dimmers are available for use with all incandescent, most fluorescent, and some mercury vapour, metal halide, and high-pressure sodium fixture, and lamps used.

A type of dimmer popular with hospitals is the power reducer: a small electrical device designed to be wired to the ballast of fluorescent fixtures. There are two models of dimmers. One typically reduces power input by one-half; the other by one-third.

Dimmer-photocell control maintains a given lighting level through combined use of electric illumination and daylight. Used for fixtures near windows and skylights, they automatically reduce fixture light output as more daylight enters the space, then increase light output as the amount of available daylight diminishes. The same type of dimmer is used to compensate for decreasing light output with age of fluorescent tubes in areas without daylight.

It must be added, however, that the efficiency of lamps is reduced overproportional to the light flux. From the point of luminous efficiency it is better to switch lamps of step by step, when it is possible.

Occupancy-based controls sense the presence of people by motion, sound, heat, or some combination, and immediately turn lighting on. After a preset interval during which people are no longer detected, lighting is automatically turned off. Occupancy controls are particularly useful for spaces such as bathrooms and storage areas, which are used irregularly during the day.

Lighting for large facilities may be controlled by an **energy management system** (EMS) or programmable lighting controller. A variety of communication systems from dedicated hard wiring to transmitters are used to connect the lighting to the controller. Some systems provide local overrides and hard-copy printouts of lighting actions taken.

6.2 Strategy

Opportunities for conservation in lighting energy use consist of preventive maintenance and updating lighting systems. When looking for energy conservation opportunities through examination of lighting installation, we must first bear this in mind:

- specific medical, nursing or research tasks need specific levels of illumination
- comfort of patients influences their recovery
- working hours are not well defined in many areas of the building, so that nurses, doctors or other staff can go and work at any time in these areas.

Consequently, energy conservation measures can never impair security nor comfort of medical staff, nursing people or patients. An optimum energy conservation schedule must begin, as usual by the appointment of a well motivated person.

At first, that person must be familiar with the existing installations in the hospital and have a detailed knowledge about specific lighting demands in different areas of hospitals and about the available techniques on the market.

Then an optimum maintenance schedule must be established. It should contain the evaluation of the actual performance of the installation and the comparison of measured values with target values.

Beside the colour of the lamps, the illumination level is the determining value for judging lighting systems.

An important factor is the amount of light falling on a certain area. It is defined as the luminous flux and measured in lux (lm/m^2). A lux meter therefore is an essential tool for the technical staff.

Obviously, it is necessary to measure lighting levels in all places, indoors and outdoors to know how artificial lighting is suited to its function.

The measurement of lighting levels obtained in places near windows by natural daylight is also important to know if it would be acceptable to switch OFF artificial lighting in these zones during some time.

Other data, which are helpful in the optimization of the lighting system, that should be measured are:

- Supply voltage

Deviations of the voltage have an effect on lamps life, and light output. Especially voltage peaks reduce the lamps lifetime, low voltage entails a lower light output. Voltage fluctuations also shorten the useful life of the ballast.

- Supply power

The measurement of the power required to obtain certain lighting levels allows the energy manager to compare these data with the target values and to follow the progress obtained by the energy management program.

- Cos ϕ of the circuitry

The phase relationship can be measured with a multiple splitcore powermeter. The cos ϕ gives a direct indication of the circuit losses and shows the possible necessity of an installation of compensation capacitors, especially in discharge lighting (see Chapter 4).

The following checklist shows what possible defects or other negative circumstances can occur. These can be evaluated even during a brief walk through the hospital facilities:

- luminaries with burned-out or flickering bulbs or tubes
- dirty luminaries that absorb light
- luminaries with yellowed covers, that absorb light
- inefficient mercury vapor lighting in parking lots
- lights turned on even though the area is well lit by daylight
- lights turned on even though no one is in the area and signs request that unused lights should be turned off

- areas that use too much lighting
- glare on TV and CRT screens
- parking lots so dimly lit as to cause concern for security
- cold, clinical looking lounges and corridors with bright overhead lights and bland walls
- brightly lit areas that contrast harshly with dark adjacent areas
- stock rooms overflowing with the large variety of replacement lamps required.

Target Values

The following tables show recommended lighting levels. For hospitals, no international standards are available. As an example for common international standards, Figure 6.2.A presents ranges of recommended illuminance for different areas or activities, prepared by the CIE.

Range of recommended illuminance (lx)	Type of area or activity
20 - 30 - 50	Outdoor circulation and work areas
50 - 100 - 150	Circulation areas, simple orientation or short temporary visits
100 - 150 - 200	Rooms not used continuously for working purposes
200 - 300 - 500	Tasks with simple visual requirements
300 - 500 - 750	Tasks with medium visual requirements
500 - 750 - 1000	Tasks with demanding visual requirements
750 - 1000 - 1500	Tasks with difficult visual requirements
1000 - 1500 - 2000	Tasks with special visual requirements
above 2000	Performance of very exacting visual tasks

Figure 6.2.A: Range of recommended illuminance for different areas.

As health care facilities are not listed herein, one can refer to values presented in the applicable norms and regulations.

In a number of hospitals, lighting measurements were taken after energy conservation measures were implemented. These reduced lighting levels were considered acceptable.

Care must be taken in following **national or local rules** which cover these subject areas, particularly lighting levels regarding the nature of tasks performed.

Design of lighting is a specialist's business and it is not the purpose of this manual to present the different methods of lighting calculations that can be found in special literature.

- Control of actions

The regular checking of the results of the actions undertaken is essential.

This checking allows comparisons from month to month (taking into account the different duration of artificial lighting) and from year to year of:

- electricity consumption for lighting
- number of replaced lamps and ballasts.

It allows also a checking of lighting levels to be sure that these are always acceptable.

This checking is made easier with the help of tables and graphs that the energy manager fills out and analyses.

6.3 How to save energy with minor changes

Pure maintenance without operational changes has two components:

- luminaries cleaning and
- bulb and ballast replacement on a routine basis.

Lack of proper maintenance wastes money and energy, and in many instances, denies patients and staff the benefits of good lighting.

6.3.1 Actions in maintenance

- Clean dirt deposited on luminaries and lamps

Lamps dirt refers to the accumulation of dust and dirt on reflecting surfaces, lamps and lenses. Ventilated luminaries generally accumulate less dust than non-

ventilated luminaries. Dust-tight luminaries must be maintained as dust will collect on the endosing surfaces.

Reflecting surfaces deteriorate gradually. Plastics in luminaries may deteriorate through age. Some plastics may discolour and reduce light transmission. Of the various plastics used, acrylics are the most resistant to use. Discoloured plastics which have lost their transmitting characteristics should be replaced. Proper cleaning materials and techniques should be used to minimize transmission losses due to:

- chemical action
- scratching of surfaces
- electrostatic dust accumulation

Plastic parts should therefore be cleaned at least once a year with a detergent that has anti-static properties. They should not be wiped dry after application of the solution, but should be air dried.

- Replace burned out lamps

Burned out lamps should be replaced as quickly as possible, even if group relamping scheme is in use. In a two-lamp series circuit, the failure of one lamp will cause the other lamp to operate at low brightness. This condition not only reduces the average lighting level in the area but also reduces the life of the second lamp and causes abnormally high currents to flow in the ballast producing a rise in ballast temperature and reducing ballast life.

If frequent burn-outs of incandescent lamps occur, it may be necessary to check and if possible to improve the ventilation of the luminaries. Unusually hot luminaries should be replaced with new luminaries or relamped with lower wattage lamps. Frequent burn-outs of incandescent lamps could also be due to overvoltage problems. Recording voltage over time may prove revealing.

- Replacement of lamps with depreciated efficiency

Light output of fluorescent lamps decreases over time. Lamp lumen depreciation is an inherent characteristic of lamps. The effect of lamp lumen depreciation on an installation can be reduced by systematic and planned relamping either individually or in groups. Careful recording of the replacement date will allow the replacement of the lamp before the lumen depreciation goes beyond acceptable limits.

- Carry out relamping and cleaning on a regular basis

The timing of relamping and cleaning is critical to retain the levels of a well-designed lighting system. Premature cleaning and relamping will waste equipment and labour, overlong intervals between cleaning will result in excessive losses of light.

Planned relamping should include recording the date of lamp replacement. Lamp replacement should be coordinated with listed expected lamp life. All lamp manufacturers publish the anticipated average lamp life. This should be considered when determining the relamping periods.

Relamping should generally take place when the lamp has reached approximately 75 to 80 % of its rated average life. In instances where lamps are often switched on and off it may be difficult to determine when that time occurs. In those instances the inspection of lamps is necessary to determine if the lamp is near its end of life. The blackening of the ends of the fluorescent tubes is usually a good indication that the lamp is near the end of its useful life. If the relamping date has been recorded, it is sometimes possible to estimate the amount of useful life remaining in the lamp after a given period. In large areas where lamps are on continuously or for definitive periods of time, group relamping is possible and desirable. In these areas, it is relatively easy to determine the number of hours that the lamps have been in service. Disposal of fluorescent and H.I.D. lamps should be done with care to avoid breaking the lamps.

A recording of all data concerning the exchange of lamps is needed to optimize a **relamping schedule**. The following example shows a possible solution.

After 20 % of the lamps of a fluo-tube-lit area are replaced because of obvious defects or because 75-80 % of the design lifetime is reached, all lamps are then replaced by new ones. By hand selection, judged after the colour change of the tube ends, the best 20 % of the lamps are kept to replace defect units during the next interval. The remaining 80 % are thrown away. When the remaining stock of used tubes is exhausted through replacing damaged tubes, all lamps are replaced and the same procedure starts again.

In relamping, care must be exercised not to relamp fixtures with higher wattage lamps than recommended. Most fixtures have a label or plate indicating the maximum permitted lamp wattage. Relamping with higher wattage lamps may create a fire hazard.

- Ballast replacement

When replacing ballasts, care must be taken that proper ballasts of similar type and manufacture are installed to provide maximum lumen output. Ballast shall be mounted solidly to the fixture body to ensure good contact for temperature dissipation and elimination of noise. At the end of life, some ballasts become noisy and replacement is necessary to eliminate the objectionable noise prior to ballast failure.

Ballasts for fluorescent lamps contain capacitors. Many of these capacitors contain a very small amount of P.C.B.s (Polychlorinated Biphenyls), which present a health hazard if it escapes. For this reason a ballast container should never be opened and capacitors should not be disposed into the regular garbage.

6.3.2 Actions with operational changes

The most direct way of reducing lighting energy use is **turning off unneeded light**. Light reduction generally is accomplished through automatic controls because they are more reliable and effective than trying to change long standing habits of behaviour. However, in some smaller facilities, the cost of automatic controls may not be justified.

In these situations it may be necessary to rely on the human element, and to instruct and encourage people to use lighting wisely.

Some people still believe fluorescent lighting should not be extinguished when leaving a room. Frequent on-off switching will reduce the usable life of fluorescent lamps, but with today's long-life lamps, the value of the energy saved almost always exceeds the value of the lamp life lost.

The cooperation of the medical staff is important because they must be relied upon to turn off unneeded lights. The entire staff as well as patients and visitors should accept the obvious changes as appropriate if the lighting program is to be successful. **A successful program must include, first, convincing people that it is worthwhile, and second, frequent reminders.**

Making people aware of what is at stake in more personal terms - a new piece of medical equipment, a pay raise, or simply keeping a job - should help produce a more enduring program.

6.3.3 Actions concerning the room surfaces

The maintenance concerns essentially lamps, luminaries and auxiliaries, but it must be remembered that high reflectivity for ceilings, walls and floors, as well as good transparency for windows increase the illumination level.

In calculating anticipated light levels, the designer should take into account the colour and the reflectance of the surface of the walls, ceiling, floors and furniture. Thus, changing the colour of the room to a much darker and light absorbing surface may drastically reduce the lighting levels. On the other hand, repainting of rooms with lighter and better reflecting paints will increase the lighting levels.

When refinishing surfaces, caution is advised to provide reflectances that will maintain or increase the designed lighting levels.

A high reflectivity coefficient is obtained through use of light colours and regular cleaning; transparency of windows is obtained by regular cleaning of these and of the curtains (if present). Cleaning personnel can be taught to use lighting more judiciously when cleaning offices, laboratories, and clinic areas after official hours.

Finally people could be reminded to conserve energy through lighting switch stickers, lighting campaign posters, hospital newsletters, and incentive programs. The hospital management must demonstrate a long term commitment to the lighting program.

6.4 How to save energy with modifying installations

6.4.1 General

The technical solutions to reduced lighting energy use can be categorized as:

- improved maintenance
 - improved controls
 - more efficient lamps
 - fewer lamps
 - improved ballast efficiency, and
 - improved luminaries efficiency.
-
- To obtain the minimum electricity costs for lighting, the best way is to light up the desired area with a sufficient illumination level at the appointed time with the highest possible efficiency.

- Sometimes, old buildings need a complete restoration of the electrical installation to meet new security standards or to supply a new lighting system.
- Lighting technology has developed quickly over the past few years. In particular, a variety of retrofit controls and power reduction hardware has appeared. These new technologies are intended to reduce lighting energy use in a more pleasing and reliable manner than the old combination of delamping and manual switching.
- The focus of this chapter, however, is on lighting energy cost reduction in existing hospitals. Design of lighting systems for new hospitals is not addressed. It is intended here to assist the plant engineer in balancing lighting operating economy with other, often conflicting, requirements. Whether a change of the whole technique or the type of lamps is more efficient on the long run has to be checked before regular maintenance actions.

6.4.2 How to approach

There are several steps in determining the appropriate program for a particular hospital. Since the lighting needs vary in a wide range for the different tasks in a hospital, the evaluation (sometimes referred to as a technical audit) should be performed on a task-by-task or area-by-area basis. In general, the steps are:

- determine the amount of light required for the tasks in the space under consideration;
- determine the type and amount of energy use of the existing lighting system for the space;
- review the options available for converting the existing lighting system into that actually needed along with increasing its efficiency;
- develop estimates of investment and operating costs and cost savings for each option and,
- calculate estimated payback periods or rate of return on investment for each option;
- use the payback period or return on investment for the most favourable option to prepare a project justification.

The modification of existing installations must be carefully designed and life cycle cost evaluations must be made with the help of a lighting specialist. Factors

influencing the overall profitability of such an operation are:

- investment cost (including material, manpower control devices, etc.)
- energy cost (lower peak power, lower energy consumption, there might even be an influence on the cooling and heating demand in air conditioned areas)
- maintenance cost
- operating hours (in areas with a long operation, the payback time for replacement of lamps is much shorter than in areas with intermittent operation)

6.4.3 Measures to be taken

- Replacement of lamps by different types

The efficiency of lamps is expressed in terms of lumen per Watt (lm/W). It is a measure of the light output from a lamp related to the electrical power input.

In general the efficiencies of various types of lamps (including ballast losses) decrease in the following order:

- low pressure sodium 100 - 150 lm/W
- high-pressure sodium 46 - 127 lm/W
- metal halide 50 - 115 lm/W
- fluorescent 42 - 88 lm/W
- mercury vapour 23 - 58 lm/W and
- incandescent 19 - 23 lm/W.

Typically, a more efficient lamp with lower wattage is substituting a given lamp. In this way the light output can be kept more or less constant while the energy use has decreased. However, several other factors should always be kept in mind when making substitutions:

- color and color rendition
- light distribution - useful life
- lamp cost
- minimum size lamp available
- lumen depreciation rate and
- time to full output.

For example, low-pressure sodium lamps, the most efficient of all, render all colours as shades of grey. This lack of color rendition makes low-pressure sodium unsuitable for most applications inside hospitals, although it may be acceptable for parking lots.

Compact fluorescent lamps are especially well suited for retrofit applications. In many applications the lamp can simply be screwed into the old incandescent socket. These

miniature lamps of 5 to 44 W can serve as replacements for incandescent lamps ranging from 40 to 150 W. They produce the same light output as an incandescent lamp with 1/3 to 1/4 of the energy use and provide a colour output close to that of the incandescent lamp.

It is also possible to replace old type (diam. 38 mm) fluorescent tubes by new ones (diam. 26 mm) without changing the ballast, although the replacement of the old ballast by a new one is often necessary due to the approaching end of its life.

For other discharge lamps however, changing a lamp by another one, even of the same type but from another manufacturer, can require the changing of the auxiliary equipment.

- Reduce the number of lamps

Optical reflectors sometimes allow a fixture to be partially delamped with very little loss in lighting level. A reflector installed in a four-tube fluorescent fixture allows the two inboard tubes to be removed and their ballast disconnected. The result is an energy saving of 50 % and a light level reduction of about 10 %, that can be compensated by the use of higher efficient tubes.

Delamping of luminaries should be the last way of reducing the number of lamps. One should then think about an installation of a complete new system that can have less luminaries due to better lamps but provide the area with at least the same quality of lighting level and light distribution.

- Improve ballast efficiency

All types of lamps except incandescent require a ballast to function. The ballast performs two functions. The first is to match the line voltage with the voltage required for striking the arc across the lamp; the second is to control lamp current after the arc has been struck.

From a strict point of view of operating costs, it is interesting to install lamps with higher luminous efficiency. But we cannot forget the consumption and losses of auxiliaries; so we define also a circuit efficiency which is the ratio of the luminous flux emitted by the lamp to the total power consumed by the lamp and its ballast.

Both the flux output and these efficiencies vary throughout the operating life of the lamp and the ballast.

High-efficiency premium-priced ballasts use 8 to 10 W less energy per pair of 50 W fluorescent lamps than standard ballasts. They are also compatible with 34 or 35 W lamps.

Electronic ballasts convert the 50 or 60 Hz input frequency to a frequency in the range of about 25 kHz. Lamp efficiency is improved, and ballast losses are reduced. Electronic ballasts tend to be more expensive than the high-efficiency regular ballasts. Depending on the type of lamps, auxiliary equipment can be placed on boards separated from lamps, where additional capacitors must be added to increase the $\cos \phi$ of the circuitry. This can make maintenance easier and shift the heat dissipated by the auxiliaries out of the room.

- Improve luminaries efficiency

Efficient generation of light by means of efficient lamps and ballasts can be negated by inefficient or poorly maintained reflectors and lenses. Both luminaries efficiency - the amount of light that escapes from the luminaries - and coefficient of utilization - the percentage of light reaching the work place in a particular application - are important.

If new luminaries can be justified, they should be selected for maintenance as well as coefficient of utilization. Luminaries should have durable, non-yellowing reflectors and lenses that can be easily cleaned.

If there is no opportunity for replacement, relocation of luminaries causing glare can improve overall lighting quality. Lowering the luminaries so that more of its light falls directly on the task is another possible improvement. Yellowed lenses can be replaced with new lenses or louvers which shield the lamps from view to prevent direct glare, and diffuse their light to control its distribution. There are so many types of luminaries that it is impossible here to describe all of them.

Regarding our energy management problem, it will be sufficient to notice the following points:

A given luminaries has specific optical properties which determine, for a given lamp, the intensity of light emitted in each direction. Changing a luminaries with another one with different optical characteristics, with or without changing the lamp(s), or substituting them (if technically feasible) by others with different lighting properties with or without changing the luminaries needs a careful redesign.

Unless the effects of these combinations are taken into account the following problems can appear:

- Reduction of comfort or security of tasks through appearance of glare, reduction of illumination levels on tasks planes or inhomogeneity of lighting;
- Reduction of operating life of lamps and/or ballasts because of an increase of their temperature;
- Increase of maintenance cost due to a more difficult cleaning of luminaries and replacement of lamps.
- More important in hospitals, however, is that in many areas the luminaries must be tight enough and installed in a way to impair bacteriological contamination, and they must resist to cleaning and disinfection products, especially in high-risk rooms (operating theater, neonatology, resuscitation, etc.)
- In areas open to public, and often in some other places like the cafeteria, restaurant, etc. ..., care must be taken about vandalism or risks of accidental shocks on luminaries.
- **Improve control systems**

Modifying the control system could be more advantageous than replacing lamps and luminaries in areas with intermittent occupancy; therefore control must be also considered in case of partial or complete retrofitting of lighting installation and electrical circuitry.

Avoiding unnecessary lighting or unnecessary illumination levels are the most important sources of energy conservation and this can only be obtained by proper control systems. Because patients, medical staff and nurses are preoccupied with health-related problems, energy conservation must be carefully emphasized.

The examination of type of occupancy and task is of prime necessity when looking at modification of the control systems. Some examples are given:

In individual or multi-patient rooms, local control by switch or dimmer, plus local lighting at the front of the bed is the rule.

In corridors, light can never be switched OFF by a clock nor a timer, but central dimming during night and lower activity hours can be considered.

In interior parking areas, a presence detection associated with a timer can be used outside high traffic hours.

The same control system should be considered in janitor, mechanical and electrical rooms, meeting rooms, restaurants, storage areas during working hours and for all areas during predicted cleaning hours (dimming during cleaning hours is not recommended because good illumination levels at that time increase the quality of cleaning which is of prime importance in an hospital).

For doctors offices, local control should be used, because of frequent time work or unregular duty.

The installation of occupancy-based controls is suitable for rooms that are used irregularly. They sense the presence of people in rooms by electronic means and turn on the light immediately. After a preset interval of no detection of people, lighting is automatically turned off.

Photosensitive control to regulate lighting in conjunction with available daylight could be installed in large administrative areas.

Rewiring the fixtures so that additional switches each control a smaller group of fixtures provides the flexibility to shut off unneeded lights.

In areas partially lit by daylight the fixtures nearest to the windows or skylights can be switched as a group so they can be turned off when the daylight provides sufficient light.

Three- or four-tube fluorescent fixtures can be rewired so that one switch controls the two outboard tubes of each fixture and another switch controls the remaining tube(s). This allows lighting energy to be reduced by half, or by two-thirds, when full lighting is not needed.

