



**International Energy Agency**

**Energy Conservation in Buildings  
and Community Systems Programme**

**Annex 20 Air Flow Patterns within Buildings**

# **Stochastic model of inhabitant behavior in regard to ventilation**

**Subtask-2 Technical Report**

C.-A. Roulet, P. Cretton, R. Fritsch and J.-L. Scartezzini

Laboratoire d'Énergie Solaire et de Physique du Bâtiment  
Ecole Polytechnique Fédérale de Lausanne  
CH-1015 Lausanne, Switzerland

Ann 20 1991:2

International Energy Agency  
Energy Conservation in Buildings and Community Systems Programme

Annex 20: Air Flow Patterns Within Buildings  
Subtask 2: Air Flows Between Zones

**STOCHASTIC MODEL OF INHABITANT  
BEHAVIOR  
WITH REGARD TO VENTILATION**

C-A. Roulet, P. Cretton, R. Fritsch and J.-L. Scartezzini

Laboratoire d'Energie Solaire et de Physique du Bâtiment  
Ecole Polytechnique Fédérale de Lausanne  
CH - 1015 Lausanne

November 1991

## Preface

### International Energy Agency

The International Energy Agency (IEA) was established in 1974 within the framework of the Organisation for Economic Co-operation and Development (OECD) to implement an International Energy Programme. A basic aim of the IEA is to foster co-operation among the twenty-one IEA Participating Countries to increase energy security through energy conservation, development of alternative energy sources and energy research development and demonstration (RD&D). This is achieved in part through a programme of collaborative RD&D consisting of forty-two Implementing Agreements, containing a total of over eighty separate energy RD&D projects. This publication forms one element of this programme.

### Energy Conservation in Buildings and Community Systems

The IEA sponsors research and development in a number of areas related to energy. In one of these areas, energy conservation in buildings, the IEA is sponsoring various exercises to predict more accurately the energy use of buildings, including comparison of existing computer programs, building monitoring, comparison of calculation methods, as well as air quality and studies of occupancy. Seventeen countries have elected to participate in this area and have designated contracting parties to the Implementing Agreement covering collaborative research in this area. The designation by governments of a number of private organisations, as well as universities and government laboratories, as contracting parties, has provided a broader range of expertise to tackle the projects in the different technology areas than would have been the case if participation was restricted to governments. The importance of associating industry with government sponsored energy research and development is recognized in the IEA, and every effort is made to encourage this trend.

### The Executive Committee

Overall control of the programme is maintained by an Executive Committee, which not only monitors existing projects but identifies new areas where collaborative effort may be beneficial. The Executive Committee ensures that all projects fit into a pre-determined strategy, without unnecessary overlap or duplication but with effective liaison and communication. The Executive Committee has initiated the following projects to date (completed projects are identified by \*).

- Annex 1: Load energy determination of buildings (\*)
- Annex 2: Ekistics & advanced community energy systems (\*)
- Annex 3: Energy conservation in residential buildings (\*)
- Annex 4: Glasgow commercial building monitoring (\*)
- Annex 5: Air infiltration and ventilation centre
- Annex 6: Energy systems and design of communities (\*)
- Annex 7: Local government energy planning (\*)
- Annex 8: Inhabitants behaviour with regard to ventilation (\*)
- Annex 9: Minimum ventilation rates (\*)
- Annex 10: Building HVAC system simulation (\*)
- Annex 11: Energy auditing (\*)
- Annex 12: Windows and fenestration (\*)
- Annex 13: Energy management in hospitals (\*)
- Annex 14: Condensation and energy (\*)
- Annex 15: Energy efficiency of schools (\*)
- Annex 16: BEMS 1 - User interfaces and system integration
- Annex 17: BEMS 2 - Evaluation and emulation techniques
- Annex 18: Demand controlled ventilating systems
- Annex 19: Low slope roofs systems
- Annex 20: Air flow patterns within buildings
- Annex 21: Calculation of energy & environmental performance of buildings
- Annex 22: Energy efficient communities
- Annex 23: Multizone air flow modelling
- Annex 24: Heat, air & moisture transport in new and retrofitted insulated envelope parts
- Annex 25: Real time simulation of HVAC systems and fault detection

## **Annex 20: Air Flow Patterns within Buildings**

A task-sharing Annex to the International Energy Agency's Implementing Agreement for a Program of Research and Development on Energy Conservation in Buildings and Community Systems.

**Objectives:** To evaluate the performance of single- and multi-zone air and contaminant flow simulation techniques and to establish their viability as design tools.

**Start:** May 1, 1988

**Duration:** 3 1/2 years

**Completion:** November 1, 1991

**Subtasks:** The work is organized in two parallel subtasks

1. Room air and contaminant flow
2. Multi-zone air and contaminant flow and measurement techniques

**Participating Countries:** Belgium, Canada, Denmark, Finland, France, Germany, Italy, The Netherlands, Norway, Sweden, Switzerland, United Kingdom, and the United States of America.

**Operating Agent:** The Swiss Federal Office of Energy (BEW). Contractor The Energy Systems Laboratory of the Swiss Federal Institute of Technology (ETH), Zurich, Switzerland. Executive OA: Dr. Alfred Moser.

**Subtask leader 1 (single room):** Ir. Tony Lemaire, TNO Building and Construction Research, P.O. Box 29, NL-2600 AA Delft, The Netherlands.

**Subtask leader (multi-zone):** Dr. Claude-Alain Roulet, LESO-PB, EPFL - Ecublens, CH-1015 Lausanne, Switzerland.

### **Specific Objectives of Subtask 1**

- . To evaluate the performance of 3-dimensional complex and simplified air flow models in predicting flow patterns, energy transport, and indoor air quality
- . to show how to improve air flow models
- . to evaluate applicability as design tools
- . to produce guidelines for selection and use of models
- . to acquire experimental data for evaluation of models.

### **Specific Objectives of Subtask 2**

- . to develop new algorithms for specific problems, as flow through large openings, inhabitant behaviour, air-flow-driven contaminants, or multi-room ventilation efficiency
- . to develop new, or improve existing measurement techniques
- . to collect and test input data sets of experimental data (reference cases for code validation)

# Table of Contents

Synopsis.....	1
1. Introduction .....	1
1.1. Importance of the Inhabitant .....	1
1.2. Driving Variables.....	1
1.3. Basic Principles of the Models .....	2
2. The Internal Door Model.....	3
2.1. Data Used For the Model .....	3
2.2. Setting up the Model.....	3
2.2.1. Activity level.....	3
2.3. The Internal Door Model.....	5
2.4. Evaluation of the Model.....	5
3. The Window Opening Angle Model.....	8
3.1. Data Used for the Model .....	8
3.2. Setting up the Model.....	8
3.2.1. Autocorrelation functions.....	8
3.2.2. Discretisation of $T_a$ and window opening angle.....	9
3.3. The Window Opening Angle Model.....	10
3.3.1. Description of the Model .....	10
3.3.2. Generation of window angle time series.....	10
3.4. Evaluation of the Model.....	11
4. The Window Opening Model .....	14
4.1. Data Used for the Model .....	14
4.2. Setting up the Model.....	14
4.2.1. Which user should be simulated?.....	14
4.2.2. How take account of several windows?.....	16
4.3. Independent Windows Model.....	16
4.3.1. Treatment of the data .....	16
4.3.2. Results .....	17
4.3.3. Generation of opening sequences .....	18
4.4. Evaluation of the Model.....	19
4.4.1. Comments on the evaluation procedure.....	19
4.4.2. Average duration of the openings.....	19
4.4.3. Number of transitions .....	20
4.4.4. Histogram of opening times .....	20
4.4.5. Temperature dependance .....	21
4.4.6. Correlations and variances .....	22
4.4.7. Time schedule.....	23
5. Conclusions.....	24
6. Acknowledgements .....	25
7. References .....	25
8. Appendix 1: Probability Distribution Functions for Door Opening .....	26
9. Appendix 2: Markov Matrices of Transition Probabilities- Window Opening Angles.....	27
10. Appendix 3: Markov Matrices of Transition Probabilities, Window Opening Model.....	31

## Synopsis

Airflow rates, hence energy consumption, are directly affected by the amount of open area and consequently by the inhabitant behavior with respect to window opening. This report describes stochastic models using Markov chains, and used to generate time series of window and door openings or window opening angles. It is based on data measured on one hand at the LESO and on the other hand by the TNO Delft on 80 identical, 16 openings dwellings located at Schiedam (NL). The models are validated by a comparison of the real and generated data. The use of these models within building air infiltration design programmes should improve significantly the likelihood of the latter.

Three models are presented:

- a model generating internal door openings and valid during the whole year for office buildings with doors equipped with hydraulic automatic shutters,
- a model simulating window opening angle versus time, and valid during the heating season for office building with a single window in each office room,
- a model generating window openings, useable mainly during the heating seasons for dwellings with several windows.

This report describes the methods used to develop the models and the models themselves. On this basis, other models, based on other measured data, could easily be developed.

## 1. Introduction

### 1.1. Importance of the Inhabitant

The importance of airflow rates on heating cost and the elimination of pollutants within buildings is a fact and already many softwares are available to simulate them [Liddament, 1989]. However, it must be pointed out that all these programmes run with unoccupied buildings, even though airflow rates are closely related to the amount of open area and therefore to the inhabitant behavior concerning window opening. For instance, measurements conducted in 25 Danish buildings shows that in average the increase in the airflow rate due to occupancy is more than 100% [Dubrul, 1988].

In order to improve future programmes a model simulating window opening during the winter has been developed and was presented elsewhere [Fritsch, Kohler, Nygård-Ferguson and Scartezzini, 1990]. This model was based on measured data from four offices of the three storey's LESO experimental office building [Harrje and Piggins, 1991]. Using a method similar described by Fewkes & Ferris [Fewkes & Ferris, 1982], the model generates time series of window opening angles with the same statistics (i.e. average opening angle, time correlation, temperature dependance, etc.) as the measured openings for the heating period.

### 1.2. Driving Variables

From the work of IEA-ECB annex 8 [Dubrul, 1988], and since the 7th AIVC conference, it is well known that the inhabitant behavior concerning the openings depends on several variables. Some of these may drive the opening and closing, some others only one of this action (e.g. the occurrence of rain may enhance the probability of closing the windows). These driving variables are listed in Table 1

Table 1.1: Possible driving variables for window opening and closing [Fritsch, Kohler, Nygård-Ferguson and Scartezzini, 1990].

External variables	Internal variables	"Human" parameters
Outdoor temperature	Indoor temperature	Time of the day
Solar radiation	Odors	Type of day
Wind velocity	Contaminants	Type of building
Rain	Moisture	Habits
Noise		etc.
Odors and pollutants		

Several intercorrelations between the openings and some of these variables were examined. It was found that the most significant one is the outdoor temperature [Fritsch, Kohler, Nygård-Ferguson and Scartezzini, 1990]. Only this variable is taken into account in the present work. This has moreover the advantage of linking the model to a data which is already used in infiltration simulation codes and generally available all around the World in each meteorological station.

The indoor temperature was considered, but not retained as driving variable, the reason being that it is difficult to handle in multiroom infiltration programmes which are seldom combined with a thermal calculation code.

### 1.3. Basic Principles of the Models

A simple way of introducing inhabitant behavior in a computer code is to record the windows and doors openings in a dwelling, at a convenient time interval and during a statistically significant time period. These recorded data could then be introduced as input schedule in the computer code, which receives that way exact information on the inhabitant behavior of the monitored dwelling. However, this method presents several inconveniences:

The recorded data are valid only together with the meteorological data synchronously recorded on the same site. It is therefore not possible to translate the recorded information to other buildings under other climates.

Only the measured inhabitant is represented that way. Other behaviors could however be introduced by performing other measurements and storing other sets of data.

The many recorded data use much memory space. One data base used within the framework of this report filled fifteen 1.44 Megabyte disks, that is about 20 Megabyte for 80 dwellings.

The purpose of the models presented below is to generate opening sequences which are similar to the measured ones, but with a very small amount of input data. These input data are obtained by statistical treatment of measured data. The opening sequence is reconstructed by random generation according to some rules resulting from that statistical treatment and is automatically adapted to the outdoor temperature.

The simplest generation is to close and open the windows following an independant stochastic process, according to frequency and opening time distributions. However, this method does not provide realistic sequences only for internal door openings; since it is well known that the opening time depends on the outdoor temperature [Dubrul, 1988] and it was shown [Fritsch, Kohler, Nygård-Ferguson and Scartezzini, 1990] that the opening angle of a window is autocorrelated, which means that the state at a given time depends on the preceding states.

The next step in complexity is the Markov chain, in which the state at one time step depends only on the preceding state. Markovian processes present a non-zero autocorrelation function, but a differential autocorrelation function which is zero, except at the origin. The Markov chain has proven to be a suitable model for simulating window opening angles.



## 2. The Internal Door Model

This model, based on measurement performed at the LESO office building, provides internal doors opening sequences. As it is the simplest of the models presented here, it is presented first.

### 2.1. Data Used For the Model

The doors of two office rooms of the LESO building were equipped with a switch and a potentiometer, allowing to record the opening and the opening angle. These doors are also equipped with an hydraulic dash-pot system, automatically closing the door within 10 seconds after release (Fig. 2.1). These rooms have only one door, the measured one.

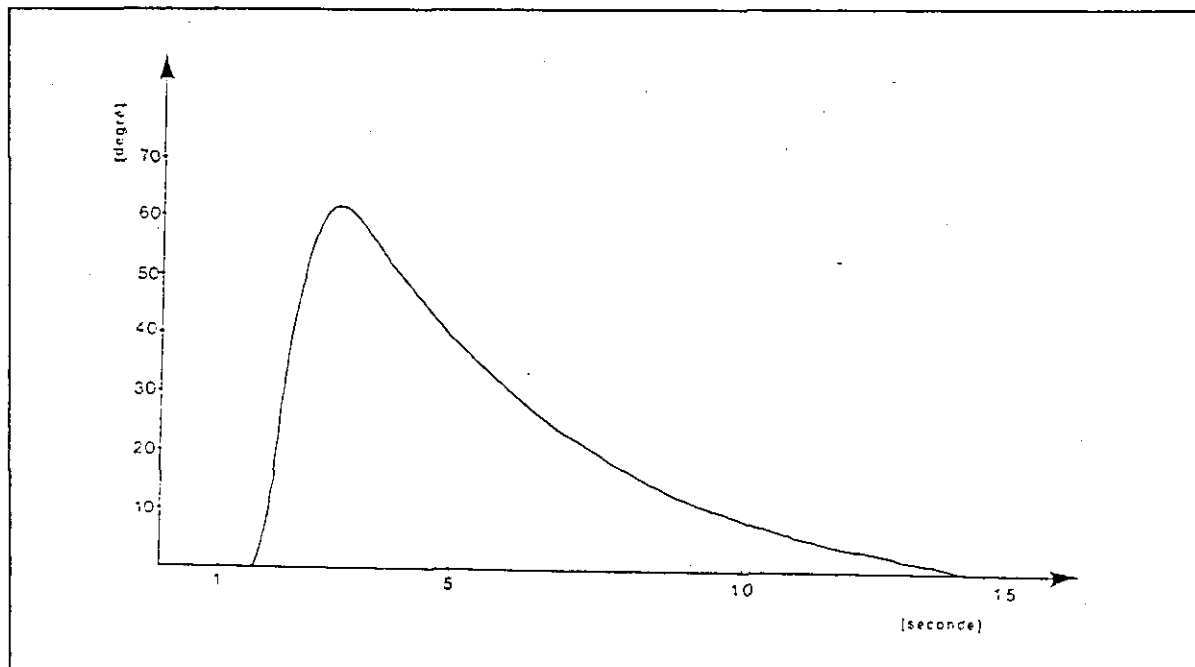

Figure 2.1: Opening angle versus time of a door equipped with an hydraulic shutter.

measurement were recorded every half hour between June 5 and August 27, 1989. Care was taken to ensure that the inhabitant behaviour during this summer period is similar to that of winter: it was not allowed to maintain the door open to ventilate the room. Only the openings necessary to let people enter and leave the office were allowed.

One room was occupied by one person only, while the other one was used by two people.

### 2.2. Setting up the Model

The model is a simple stochastic model, but the distribution of the door openings changes with the activity of the occupants, i.e. with the time during the work day.

#### 2.2.1. Activity level

The daily opening frequency schedule is shown on Figure 2.2. It is clearly related to the schedule of the occupants (work hours, coffee breaks, lunch, etc).

To take account of that non stationary schedule, the door opening activity is defined as the number of door openings within half an hour, and activity levels thresholds were chosen. It was shown [Scartezini, Fritsch, Kohler and Nygård Ferguson, 1990], that the real behavior was best reproduced by defining four activity levels, whose thresholds are shown on Table 2.1.

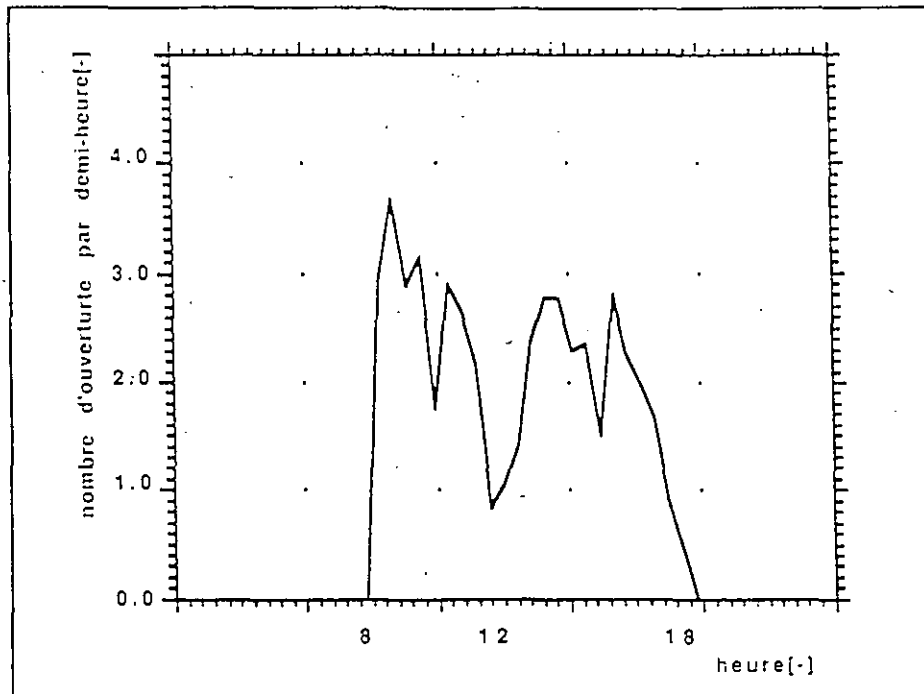

Figure 2.2: Average daily schedule of the door opening frequency during the measurement period, for the two-person office.

Table 2.1: Activity levels for door openings.

Activity level	Critical number of door opening per half hour
Very low	0 to 1
Low	1 to 2
Medium	2 to 3
High	More than 3

From a new set of data, containing the number of door openings during each time step, the following steps should be performed in order to obtain the parameters for the model:

- 1 Adopt a convenient time step, either according the time step of the measured data or the time step required when using the model, which should be an integer multiple of the former.
- 2 Determine the daily schedule of the occupant, by averaging the door openings for each time step within the day, over the whole measurement period.
- 3 Define the critical thresholds for the activity level, or adopt those shown on Table 2.1, and determine, from these and from the schedule, the average activity level of each time in the day.
- 4 Scan the measured data to obtain the four door opening distributions corresponding to the four activity levels. For that purpose, open a table with four columns for the activity and 15 or more lines corresponding to the number of openings during a time step. Then, at each time step:

- determine the activity level,
- add 1 to the box in the table corresponding to the activity level and to the recorded number of openings.

Once this scan ended, divide all the elements of each column by the sum of the corresponding column, in order to obtain the door opening distribution functions corresponding to each activity level.

- 5 Record these four distribution functions and the daily schedule.

### 2.3. The Internal Door Model

The technique used to reproduce synthetic data refers to the inverse function method [Bartlett, 1979]. This method is commonly used with stochastic processes and therefore will just be presented roughly here.

The inverse function method allows the generation of time series of a stochastic process given its distribution function. The only requirement is to dispose of a random number generator with a uniform probability density function between 0 and 1. The generated numbers, going from 0 to 1, are compared to the distribution function as shown on figure 2.3: for every number given by the generator, there corresponds only one state.

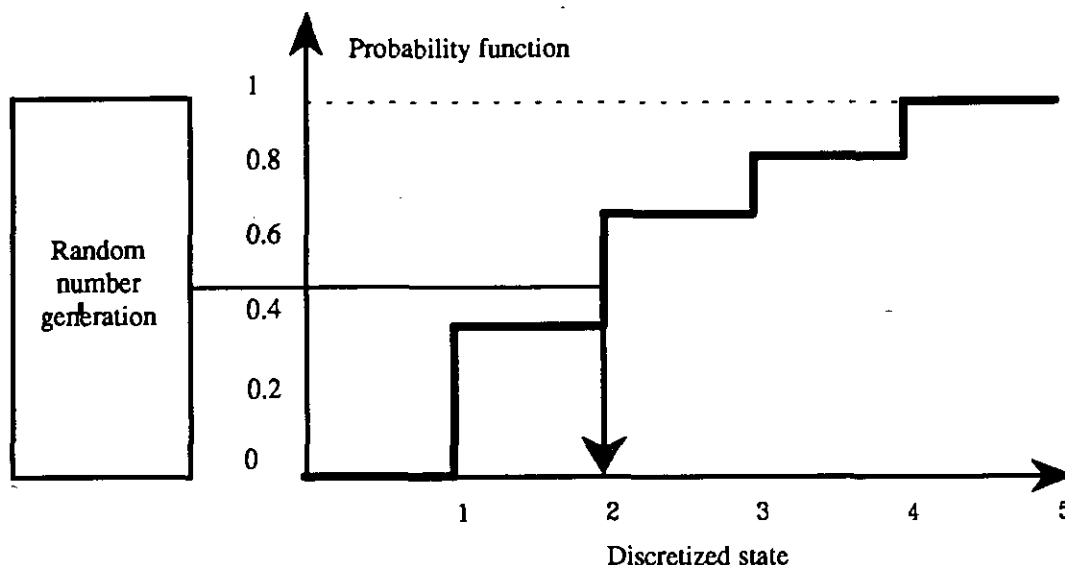

Figure 2.3: Generating a new state according a distribution function.

The procedure to be followed for generating door opening sequences is the following:

At each time step:

- 1 Take the time of the day. Outside office hours, the number of door opening is zero, and jump to the next time step.
- 2 From the time of the day and the recorded schedule, determine the activity level
- 3 Select the opening distribution function corresponding to that activity level
- 4 Take a random number according to that distribution function (see fig. 2.3). This is the number of door openings during that time step.
- 5 Jump to the next time step.

Opening distribution functions are provided in Appendix 1.

### 2.4. Evaluation of the Model

The evaluation of the model is based on the comparison of the main statistical characteristics of real and rebuilt door opening data. Figures 2.4 and 2.5 result from this evaluation.

Moreover, 20 simulated data were produced to compare the distribution functions of the door openings. Table 2.2 shows these distribution functions, which are very close each other.

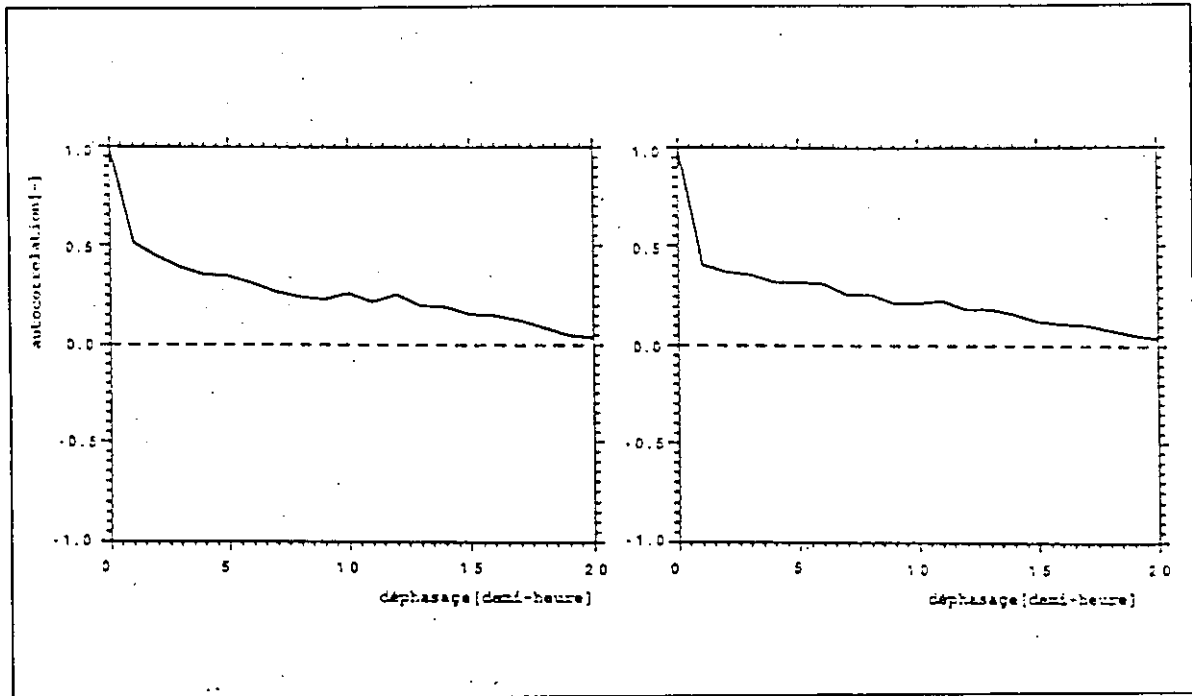

Figure 2.4: Autocorrelation functions of the original (left) and rebuilt (right) data. Their similarity shows that the time dependence of the door opening frequency is correctly reproduced.

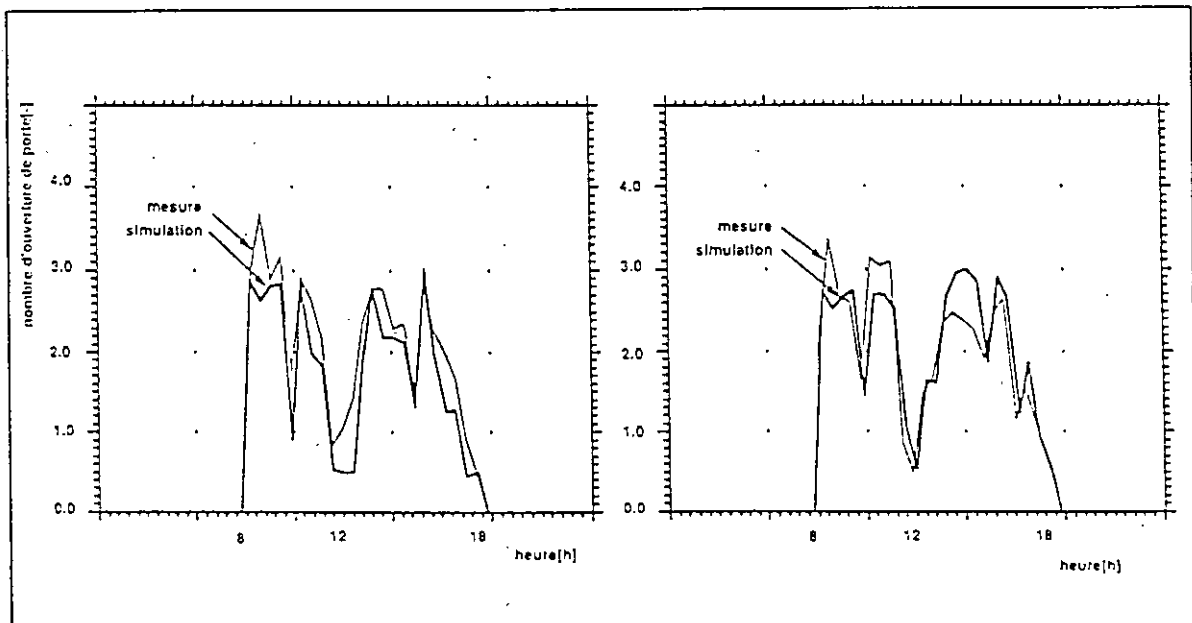

Figure 2.5: Measured and simulated opening frequency schedules for both offices.

Table 2.2: Measured and simulated distribution function of door openings for both office rooms.

Number of door openings during 30 minutes	Office with on occupant		Office with two occupants	
	Measured Probability	Calculated Probability	Measured Probability	Calculated Probability
0	0.2818.	0.2790.	0.3132.	0.3152
1	0.1242.	0.1247.	0.0828.	0.0833.
2	0.1452.	0.1461.	0.1043.	0.1043
3	0.1144.	0.1147.	0.1108.	0.1087
4	0.0842.	0.0832.	0.1072.	0.1072
5	0.0712.	0.0726.	0.0696.	0.0675.
6	0.0690.	0.0707.	0.0618.	0.0616.
7	0.0298.	0.0283.	0.0429.	0.0442.
8	0.0320.	0.0318.	0.0324.	0.0341.
9	0.0139.	0.0143.	0.0205.	0.0197.
10	0.0073.	0.0067.	0.0165.	0.0152
11	0.0087.	0.0086.	0.0083.	0.0101
12	0.0058.	0.0058.	0.0074.	0.0072
13	0.0036.	0.0036.	0.0081.	0.0072
14	0.0015.	0.0012.	0.0086.	0.0087
15 and more	0.0074.	0.0087.	0.0056.	0.0058
Average frequency [h <sup>-1</sup> ]	2.915	3.088	3.175	3.173

### 3. The Window Opening Angle Model

This model provides window opening angles, and is based on measurements taken on the LESO building, which is an office building.

#### 3.1. Data Used for the Model

The model developed is based on measurements taken every half hour in four office rooms located south in the LESO building [Scartezzini, Faist and Gay, 1987]. All the rooms are identical, except for the facade, and each one is occupied by two persons (Figure 3.1).

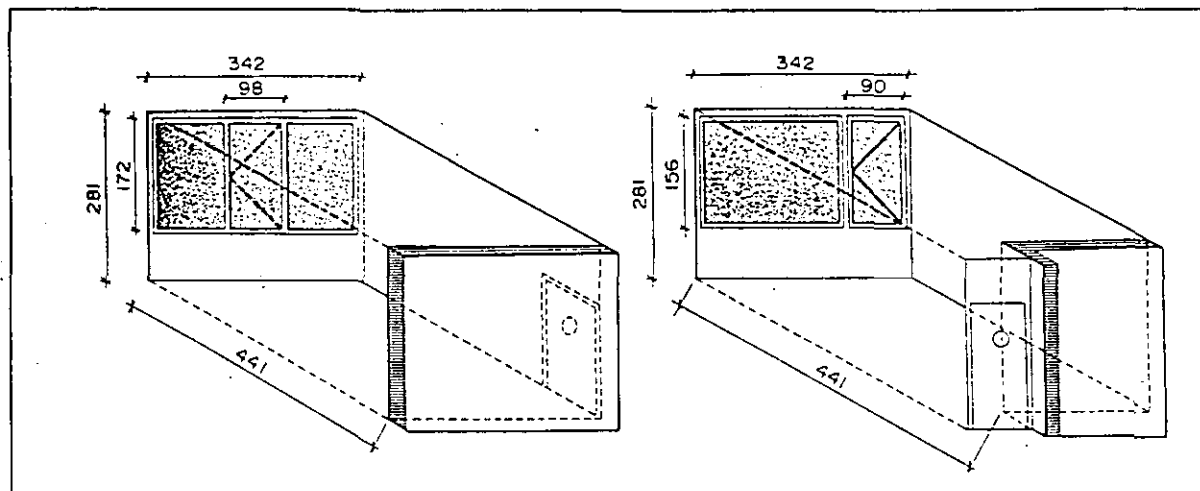

Figure 3.1: The two monitored office rooms which provide the data for the model.

The GDIR rooms are equipped with a direct solar gain façade. It is comprised of double glazed windows sustained by wooden frames covered with aluminium. The breast wall is made of wood and glass wool protected by Eternit panel ( $U = 0.4 \text{ W/m}^2 \text{ K}$ ). There is one site mounted casement window (156 x 90 cm) on the side. For a volume of  $86 \text{ m}^3$ , the average air change rate due to infiltration is  $0.39 \text{ h}^{-1}$  [Scartezzini, Roecker, Quévit, 1985].

The second facade of the remaining two rooms based on thermal high insulation technique (HIT facade) consists of double glazed windows with two infrared films inbetween, frames of polyurethane foam in aluminium profile. The breast wall is also made of polyurethane foam protected by metal sheets ( $U = 0.25 \text{ W/m}^2 \text{ K}$ ). There is one site mounted casement window in the center of dimension 78 x 152 cm. The volume is the same as before,  $86 \text{ m}^3$ , and the average air renewal rate due to infiltration is very low,  $0.16 \text{ h}^{-1}$ .

The opening angle of the four windows is measured every half hour and stored on magnetic tapes. The winters of 83/84 for the local HIT and 84/85 for the local GDIR were used for the model construction and validation. Meteorological variables such as ambient temperature, wind speed or the south vertical solar radiation as well as the inside temperature were also available.

#### 3.2. Setting up the Model

##### 3.2.1. Autocorrelation functions

The first approach was to analyse the autocorrelation functions of the measured data. Figure 3.2 present the autocorrelation as well as the differentiated autocorrelation of the window opening angle. From the first one we can observe that the dependance between two successive measurements (30 minutes delay) is strong : this simply states the fact that a window is usually left in one position for long periods of time. On the other hand, the differentiated autocorrelation function shows clearly that there is not any significative dependance at a greater order. We can deduce from both these graphs that the probability of finding a window in a certain position depends only of its precedent position and not any other ones. Therefore we can assume that discrete Markov chains can be used to make a suitable model. A Markovian process has no memory : the next state

will depend only of the present state and no others. Thoroughfully described in the literature [Kemeny & Snell, 1976], it is rather simple and commonly used.

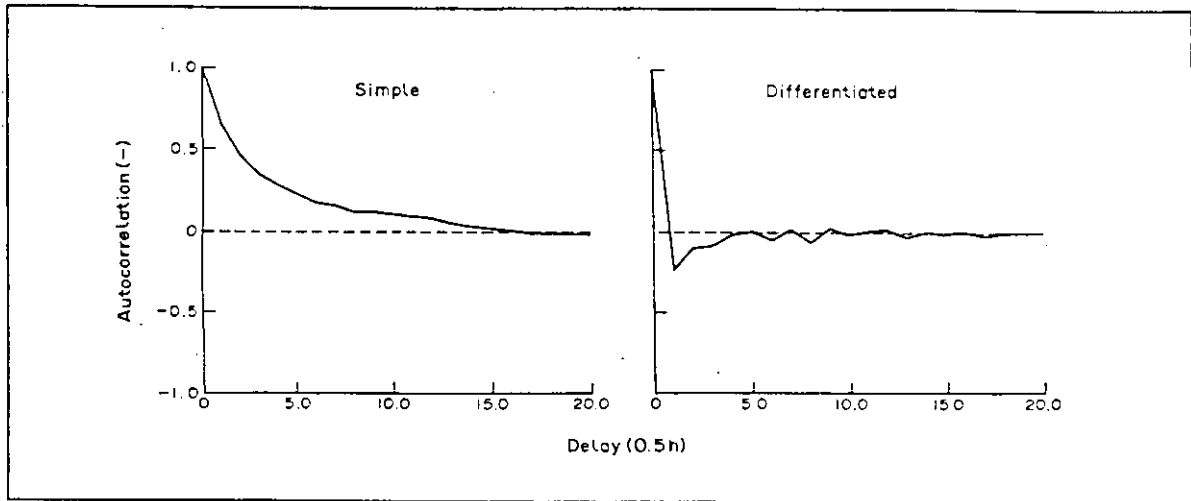

Figure 3.2: Simple and differential autocorrelation functions for the window opening angle in the GDIR west room, during the winter 1984-1985.

### 3.2.2. Discretisation of $T_a$ and window opening angle

Since the model refers to discrete Markov chain, the outdoor temperature and window opening angle were divided into classes. The airflow rate through our single window office rooms versus the opening angle follows a known curve shown on Figure 3.3 [Warren, 1978].

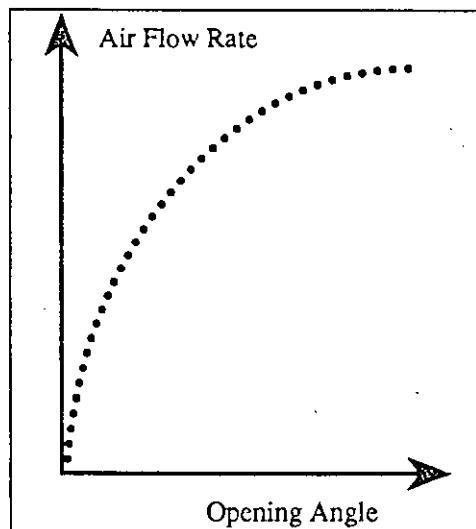

Figure 3.3: Air flow rate through an open window [Warren, 1978].

In order to obtain meaningful average airflow rates, it is obvious that narrower classes should be chosen at small angles. We set ourselves upon  $[0, 1 [$  (closed),  $[1, 15 [$ ,  $[15, 35 [$ ,  $[35, 60 [$ ,  $[60, 90 [$ ,  $[90, +\infty[$ . In the model the value taken by a window angle inside a class was the average of the measured angle inside the same class throughout the whole year. Then, reporting these classes on the bi-parametric graph, dense part of the cloud were isolated and decided of the ambient temperature classes :  $] - 273, 0 [$   $[0, 8 [$ ,  $[8, 16 [$  and  $[16, +\infty [$ . (Figure 3.4).

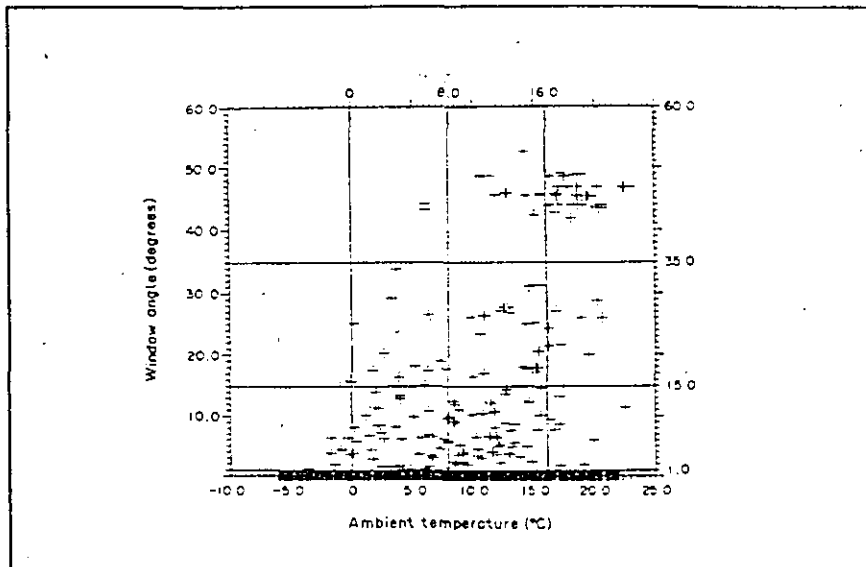

Figure 3.4: Window angle and temperature classes on the bi-parametric graph [Fritsch et al., 1990].

### 3.3. The Window Opening Angle Model

#### 3.3.1. Description of the Model

The winter model is based on six states Markov chains. Each one of the states corresponds to a definite class of window opening angles.

During office hours, that is to say 8 : 00 am to 6 : 00 pm, four different Markov chains realized the link between the ambient temperature and the inhabitant behaviour concerning windows. Every one of them refers to a class of temperature (taken from ] - 273, 0[, [9, 8 [, [8, 16 [, [16, + ∞[ ). The four matrices, corresponding to the four chains, were derived for a definite winter and for a precise office room : the matrices elements are the probabilities of moving a window to a certain angle given a certain temperature and they depend closely on the inhabitants and particularities of a room.

During the night and week-end, we have imposed the window to be closed. This is due to the fact that only two occurrences of window opened all night were found during the whole winter and for the four rooms considered.

#### 3.3.2. Generation of window angle time series

To generate the time series, the procedure is the following (Figure 3.5):

- 1 Check the time, if it is not in the office hours the window is closed and go to step 5
- 2 Choose a Markov matrix according to the outdoor temperature
- 3 Build the distribution function from a line of the matrix
- 4 Generate a new realization for the window position for the next time step
- 5 Memorize the window position or window angle class
- 6 Start in step 1 for the next time step.

Appendix 2 provides Markov matrices for four different office rooms, with different occupants.



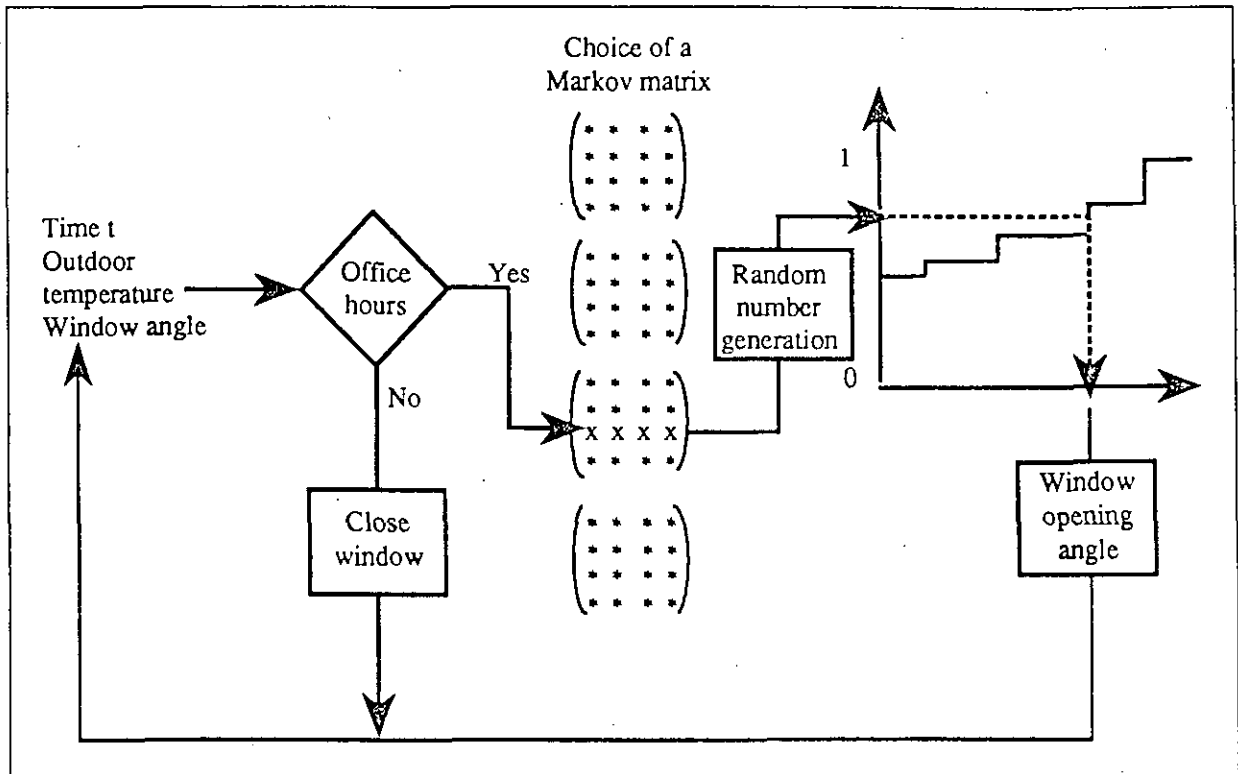

Figure 3.5: Procedure for the markovian generation of window opening angle.

### 3.4. Evaluation of the Model

For comparison purposes, synthetic and real time series of window angle are reproduced in figure 3.6. In order to validate our model, the major characteristics of the generated data was compared to reality.

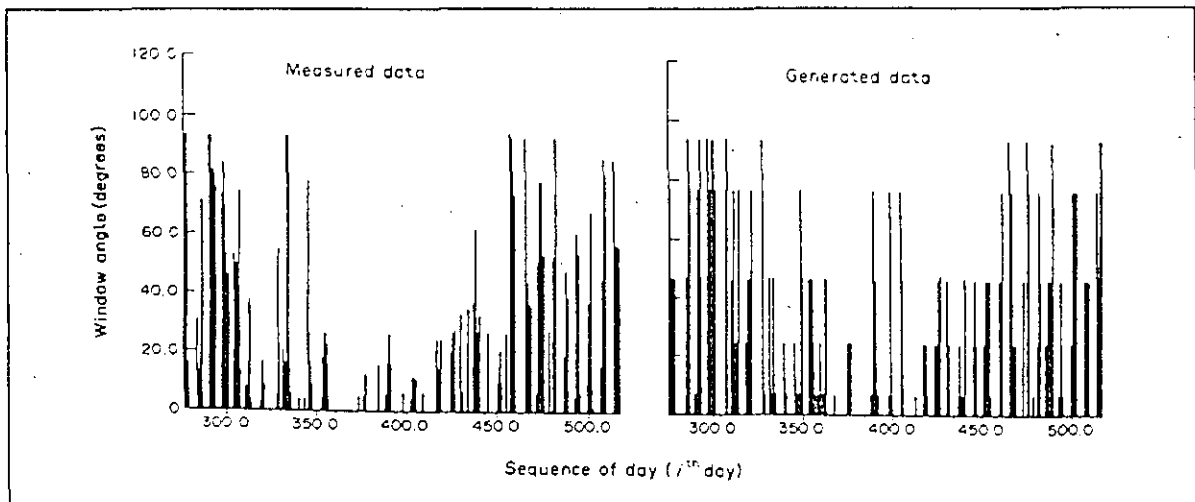

Figure 3.6: Real and synthetic time series for the window angle (winter 1984-85, room GDIR west).

The first stage was the comparison of the auto and inter-correlations calculated from the synthetic and real time series of window opening angle. The general shapes of the autocorrelation are very similar (see Fig. 3.7). It is therefore possible to conclude that the time dependance was respected : for a given temperature, both the window represented by the synthetic data and the real window stay open the same amount of time. The intercorrelations between the window opening angle and the ambient temperature were also considered. It is clear that the link is very strong in both cases (Fig. 3.8).

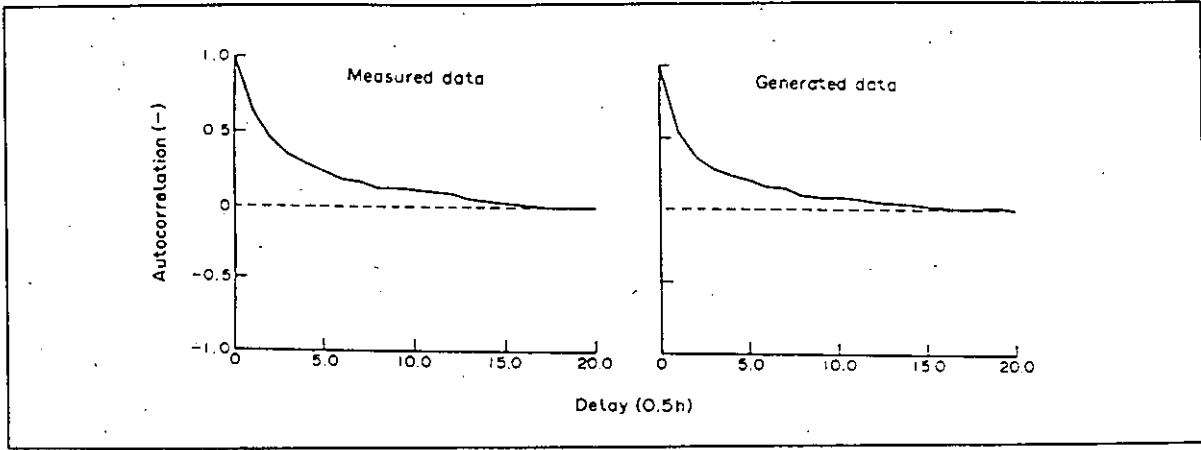

Figure 3.7: Autocorrelation function of the measured and generated series for the winter season (winter 1984-85, room GDIR west).

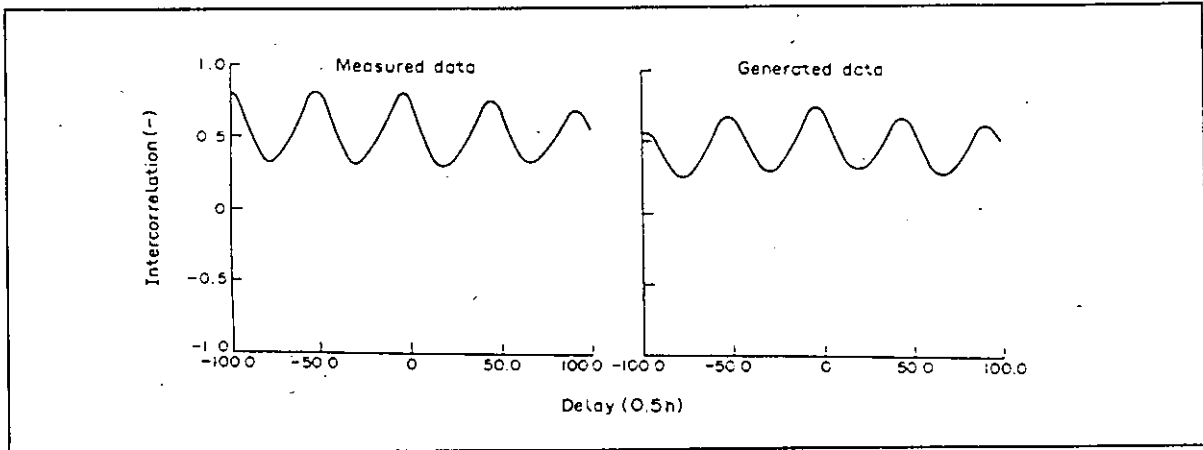

Figure 3.8: Intercorrelation function between the window angle and the ambient temperature (winter 1984-85, room GDIR-west).

Then we studied the average opening angle over the winter. Figure 3.9 represents the histogram of the average of 14 simulations (14 winters). The mean of this histogram was computed and a 95% confidence interval was estimated. The measured mean was found to be in the interval in all four offices considered.

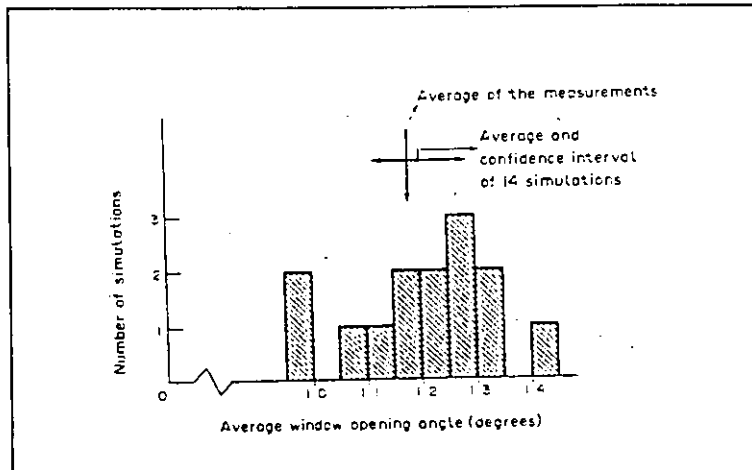

Figure 3.9: Histogram of the averages of 14 simulations of the opening angle, compared to the measured average on the whole winter (room GDIR-west).

And last, the histogram of generated (14 simulations for each room) and measured probabilities of finding the

window open at an angle within a certain class were compared (Table 3.3). The comparison is very satisfying. The probability to be right by accepting the model cannot be deduced from the  $\chi^2$  test based on only one histogram, but a  $\chi^2$  test at 95% is satisfied if the comparison is made with an average histogram of several calculated series

**Table 3.3:** Comparison of the measured and calculated probabilities to find the window open at a given angle and  $\chi^2$  test. The probability shown under and at the right of the  $\chi^2$  value is the probability to be wrong when rejecting the proposed model.

Office Opening angle class	HIT W		HIT E		GDIR W	
	Measured	Calculated	Measured	Calculated	Measured	Calculated
[ 0, 1[	0.9786	0.9791	0.9938	0.9938	0.9605	0.9608
[ 1, 15[	0.0111	0.0113	0.0044	0.0043	0.0164	0.0174
[15, 35[	0.0045	0.0051	0.0007	0.0007	0.0084	0.0071
[35, 60[	0.0058	0.0045	0.0011	0.0012	0.0079	0.0075
[60, 90[	0	0	0	0	0.0069	0.0072
$\chi^2$	3.65		0.18		2.84	
Probability	30%		98%		55%	

## 4. The Window Opening Model

This model is very similar to the preceding one, but is based on measurements performed in dwellings, and provides only the status (open or closed) of the windows.

### 4.1. Data Used for the Model

The model developed here is based on measurements recorded every 10 minutes in 80 dwellings of a 10-floor building located at Schiedam (Netherlands) [*de Gids, Phaff, van Dongen and van Schjindel, 1985; Phaff, 1986; van Dongen, 1986*]. All the dwellings are similar (Figure 4.1) and there are 14 dwellings per floor. Each dwelling has 14 windows and two doors, located on both facades as shown on Figure 4.1.

Measurements of the window opening (using switches) were taken at very short time intervals (20 seconds). In order to discretize the time scale as required by the Markov chain, a time step of 10 minutes was adopted as a compromise, large enough to limit the number of data, and not too short in order not to lose too much accuracy. The opening time during these intervals was calculated for every window. When that opening time was larger than 5 minutes, the window was considered open during 10 minutes, and considered as closed if the open time was less than 5 minutes.

Each dwelling having 14 windows and 2 doors, the status of these was recorded as two bytes of 8 bits, that is 2 ASCII characters. Meteorological variables such as outdoor temperature, wind speed, solar radiation and rain as well as inside air temperature and inlet and outlet heating water temperatures were also recorded.

The measurements used for that study were taken during 118 days from winter to summer. These were taken out of longer files, using the following criteria:

- both meteorological data and window openings should be available at each time step,
- there should not be more than 20 minutes between two measurements, i.e. not more than one missing measurement. If one measurement was missing, the preceding data were taken without change.
- series of data with less than 100 measurements (that is shorter than 16.7 hours) were eliminated.

This resulted in a file of 17 043 measurements at 10 minutes interval, which is a pack of several smaller files. The transition between two files (i.e. during apparent time intervals larger than 10 minutes) were not taken into account in the analysis. The final number of valid transitions is then 16 976.

### 4.2. Setting up the Model

The Schiedam measurements are window and door openings (that is either 0 for closed or 1 for open) and each dwelling has 14 windows and two doors, whose opening probabilities are likely to be correlated. The existing model should therefore be modified first to provide time series of openings instead of angles, but also to take account as far as possible of the many windows in a dwelling.

The difference between the opening angle and the opening indicated by a switch is a trivial but important change: the 6 classes of opening angle of the preceding model are replaced by only two: closed or open. Since the air flow rates through a window depends on the opening angle, it is an important issue and maybe a dramatic approximation. However, there are, at our knowledge, no available data providing the opening angle for many windows in dwellings and this model should be based on existing measured data.

#### 4.2.1. Which user should be simulated?

It is well known [*Dubrul, 1988*] that the inhabitant behaviors differ much from each other, and these differences give the basic reason to take them into account in the simulations. Since the measurements were performed on 80 dwellings, there is a large choice of behaviors. Whose of these should be chosen? Which criteria could be used for that choice?

The criteria could be the total opening time of all the windows and doors, the total number of changes or some more complex criterion such as the extra air change rate induced by the behavior. The latter is too complex to be handled and the total opening time was taken as criteria, since it is more related to air flow rates than the number of opening.

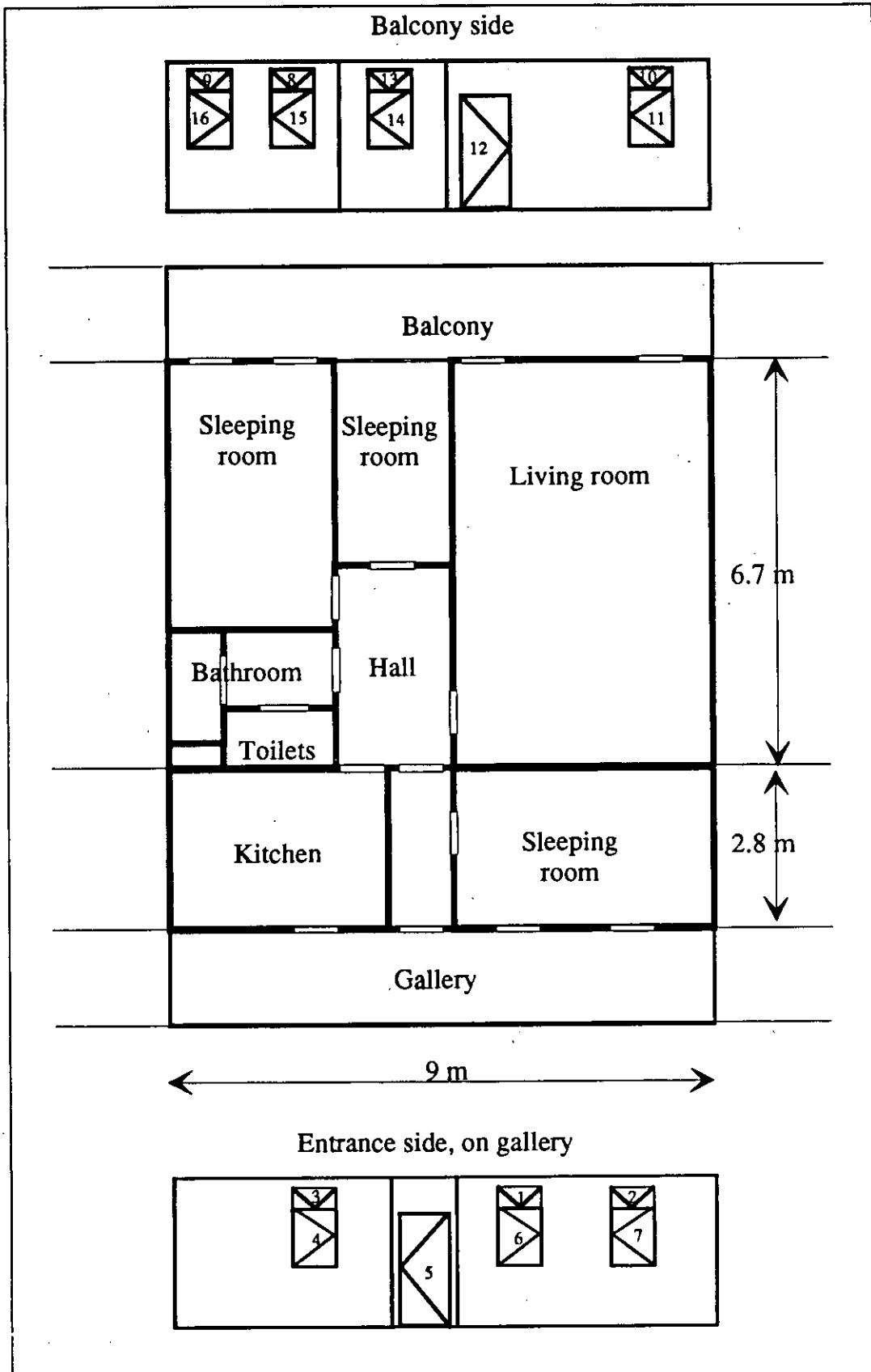

Figure 4.1: Floor plan of a dwelling and position of windows and doors in the facades and the corresponding numbers [de Gids, Phaff, van Dongen and van Schjindel, 1985]

One can choose an "average" inhabitant, a "closer", or an "opener". Note that the definition of the "average" dwelling is not obvious. First of all, none of the 80 dwellings has opening times close to the general average for each window. Therefore, it makes no sense to generate an artificial average user by averaging the data over the 80 dwellings. It is proposed here to choose one user which is close to the general average.

This could be the one with the average opening time,  $\mu$ , closest to the general average (the average being taken as well on time as on the windows), or the one which is the closest for each window and door, that is the one which has the smallest standard deviation,  $\sigma$ , to the average for each opening, summed over the 16 windows and doors.

Some figures are given in Table 4.1, which shows the dramatic differences between the dwellings. In this Table,  $m$  is the average of the corresponding line and  $s$  is the standard deviation between the corresponding line and the global average. Note that the database used to make that table and hence choose the interesting users is slightly smaller than the complete database used for the rest of the work.

Table 4.1: Relative windows (and doors) opening times, in ‰, for some selected dwellings.

Side Type of room	Gallery side						Balcony side						$\mu$	$\sigma$				
	Bedroom		Kitchen		Door	Living		Bed		Large bedroom								
Opening No:	1	2	6	7	3	4	5	10	11	12	13	14	8	9	15	16		
Global average	156	90	24	19	137	14	6	45	13	20	142	77	257	89	167	36	81	
Average users (see text):																		
smallest $\sigma$	135	0	2	0	107	1	1	7	0	1	143	12	303	0	15	0	45	58
closest $\mu$	18	4	6	0	145	2	2	0	0	6	320	18	607	99	134	0	85	113
"Closed" user	168	0	7	0	47	10	1	0	0	3	39	10	12	0	4	0	19	93
"Open" user	108	340	0	0	684	0	1	333	1	30	764	938	616	330	11	53	263	345

#### 4.2.2. How take account of several windows?

The proper way allowing one to take account of the presence of 16 windows in a dwelling is not so obvious, since there are several possibilities. The model based on Markov chains reproduces transitions between states. The variable(s) representing the state should therefore be first defined.

Having 16 openings, a basic state of these could be represented by a 16-bit word, each bit representing one opening, and be 0 when the window is closed and 1 when open. There are theoretically  $2^{16}$  (about 65 000) such states, hence  $2^{16} \times 2^{16}$  possible transitions whose probabilities could be represented in a square matrix with more than 4 billion numbers for each temperature class. Most of the elements of this matrix are zero and will not be stored but, nevertheless, this solution is neither practical nor possible. In particular, there are not enough available data (only about 17 000 transitions) to calculate the transition probabilities.

At the other end of the spectrum, each window could be considered as independent, with two states. In this case, the window and door openings of the dwelling would be modelled by 16 transition matrices,  $2 \times 2$ , that is 64 transition probabilities for each temperature class. This model can obviously not reproduce any intercorrelation between the opening sequence of different windows

Any intermediate model could be chosen between these extremes. As a first approximation, the simplest model is developed and tested below.

#### 4.3. Independent Windows Model

The 16 windows and doors are assumed to be independent from each other and are treated separately. The state variables are the state of each window or door, e.g. 0 for closed and 1 for open. There are hence four transition probabilities (0 to 0, 0 to 1, 1 to 0 and 1 to 1) for each window and each temperature class.

##### 4.3.1. Treatment of the data

To fill-up these  $16 \times 4$  matrices (16 for each temperature class), the measured data were treated the following way:

- 1 A building is chosen and a file is generated from the big basic data file. This file contains, for the 17 000

time steps of 10 minutes, the meteorological data and the 16 window (or doors) openings of the chosen building.

Then, at each time step and for each window or door:

- 2 the outdoor temperature is examined and the corresponding class noted,
- 3 the type of transition from the preceding state to the present one is determined and the corresponding element in the transition matrix for that window and that temperature class is incremented by 1. The elements are arranged as shown below:

Closed to Closed	Closed to Open
Open to Closed	Open to Open

- 4 When the complete file is treated that way, the elements of the transition matrices are divided by the sum of their lines or by 1, whichever is larger. This gives the 16 x 4 matrices of transition probabilities, for each window and each temperature class. Their elements are the transition probabilities to pass from the initial state to the next state. Since the windows are moved at time intervals which are generally much more than 10 minutes, these matrices are mainly diagonal.

If a line does not contain any transition, the window is either always closed or always open. The corresponding transition matrices are then artificially modified as shown below:

Always closed

$$\begin{pmatrix} 1 & 0 \\ 1 & 0 \end{pmatrix}$$

Always open

$$\begin{pmatrix} 0 & 1 \\ 0 & 1 \end{pmatrix}$$

This slight change ensures first that the sums of the lines are equal to one, as should be the sum of transition probabilities, and secondly that the corresponding window will be put in its permanent state at the first time step, even if the starting state does not correspond to the reality.

4.3.2. Results

The four dwellings presenting an interesting average opening time as shown in Table 4.1 were treated that way. The 16 976 valid measurements were distributed between the temperature classes the following way:

Temperature class	[- 273, 0[	[0 to 8[	[8 to 16[	16 & more
Number of measurements	2743	7495	4241	2497

The Markov transition matrices are given in Appendix 3, and can be used in computer codes as described in Section 3.2 below.

Some interesting statistical data are shown in Table 4.2. Note that, for all the four chosen dwellings, the window 7 is always closed and the entrance door (5) has a high probability of closing when open. Each dwelling has at least two windows which are always closed. The generous opener (dwelling 41) has three windows which are open more than 95% of the time and his windows 2 and 14 are always open.

Table 4.2: Number of time intervals during which the window, (i = 1 to 16) is open.

Dwelling	1	2	3	4	5	6	7	8	9	10	11	12	13	14	15	16	sum
(small o)	5850	0	3922	105	103	220	0	9302	0	2211	307	1036	2736	1565	2278	0	29635
(closed)	5768	5727	2552	201	73	1226	0	2982	325	1	0	1807	3348	1985	1225	764	27984
(open)	5148	16973	11766	55	24	8	0	16976	3034	11570	0	5688	16196	16976	9827	859	115100
(same μ)	179	28	2532	36	32	60	0	12692	8599	60	0	837	1260	5781	3839	0	35935

Number of changes from open to closed or vice-versa, for each window or door (i = 1 to 16).

Dwelling	1	2	3	4	5	6	7	8	9	10	11	12	13	14	15	16	sum
(small o)	218	0	388	36	60	36	0	149	0	65	44	223	99	76	136	0	1530
(closed)	74	5	120	81	48	50	0	26	2	2	0	162	8	93	78	10	759
(open)	11	1	239	18	28	1	0	0	13	25	0	192	15	0	45	25	613
(same μ)	14	4	291	16	36	14	0	27	39	2	0	152	1	139	215	0	950

4.3.3. Generation of opening sequences

The following reconstruction procedure should be used for that model:

- 1 At time  $t_0$ , a starting pattern of open windows is chosen arbitrarily.
- 2 The value of the outdoor temperature is examined, and the corresponding temperature class  $T$  ( $[- 273, 0[$ ,  $[0, 8[$ ,  $[8, 16[$ ,  $[16, + \infty[$ ) is noted. Choose the 16 transition matrices corresponding to that class.
- 3 The line of the transition matrix corresponding to the state of the window  $j$ , contains the transition probabilities  $P(S_0, S_j)$  to have the window in state  $S_j$ , at time  $t_j$ , knowing its preceding state  $S_0$ . Build the from that line of the matrix: the probability to become (or stay) closed is given in the first column and the probability to become either closed or open is 1.

The new state is generated at random according the distribution function, using the inverse function method. In this case, the distribution functions have only two steps and are deduced from the lines of the Markov matrices.

- 5 Repeat the procedure from step 2 for the next time steps.

To take account of the very low night activity, the openings could be left unchanged from midnight to 7 AM. This was however not done in this work.

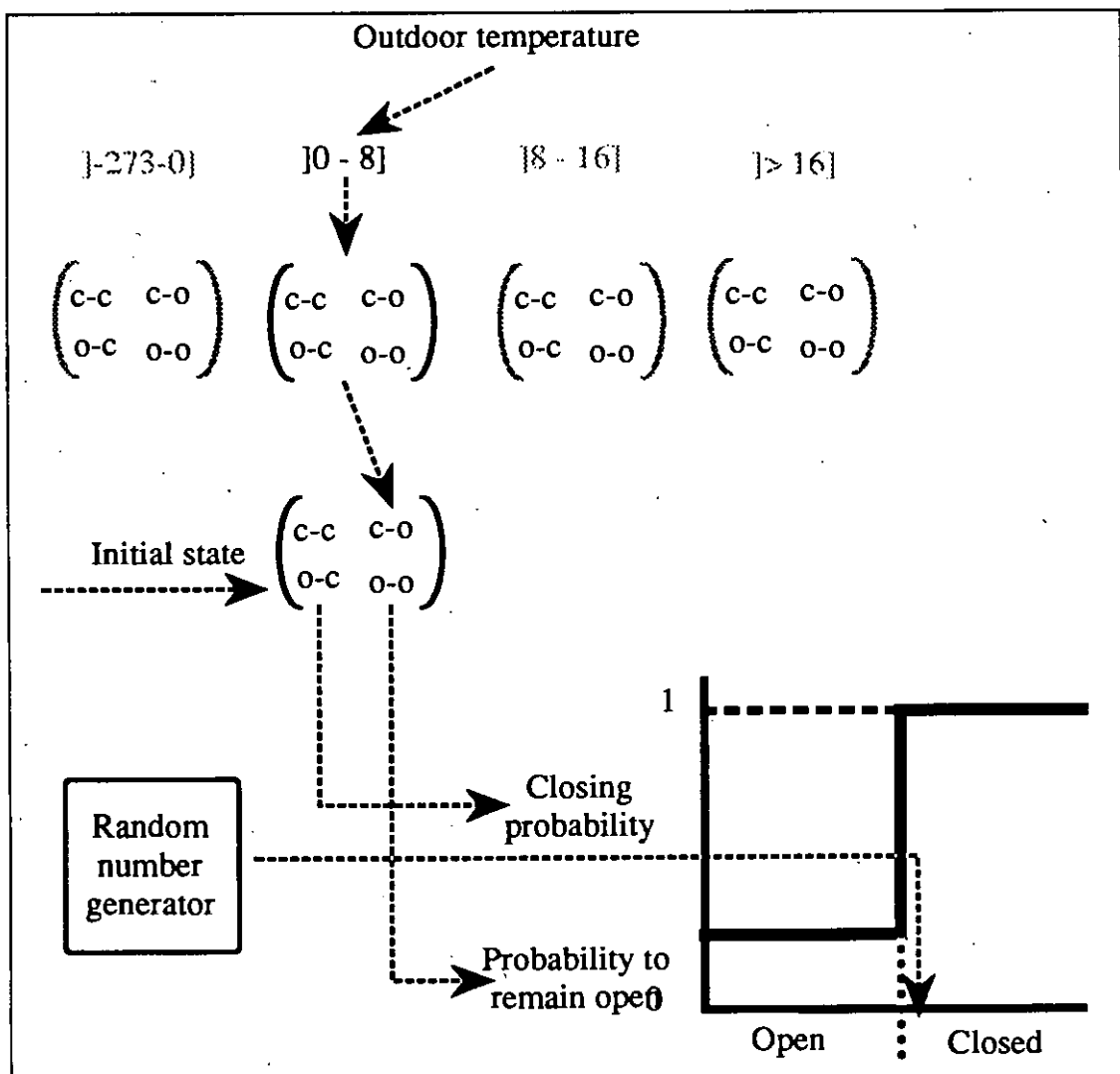

Figure 4.2: Generation of opening sequences.



#### 4.4. Evaluation of the Model

##### 4.4.1. Comments on the evaluation procedure

It should first be stated here that a good evaluation procedure is to compare the air flow rates measured in a dwelling with the corresponding air flow rates obtained by a computer code using the presented model with its Markov matrices based on measurements in the same dwelling. Another, simpler possibility could be to compare computer code results for the same dwelling, obtained on one hand with measured opening schedules and on the other hand with opening schedules generated by the present model. These methods could however not be used within the present work, by lack of time to adapt an existing multizone infiltration code. This adaptation would require not only the present model but also a routine calculating air flow rates through large openings. This could be performed within the Annex 23 of the IEA-ECB research program.

A first estimate of the performances of this model can however be obtained by comparison of major characteristics of the generated data with reality. The compared characteristic are opening duration, frequency of changes, relation with the outdoor temperature and inter correlations between openings.

For that purpose, 6 opening schedules were reconstructed using the procedure described in Section 4.3 and the Markov matrices corresponding to the dwelling 43, whose total opening time was the closest to the global average. A different seed for the random generator was used for each schedule, but the real first state (i.e. the real status of the 16 openings at the first measurement) was always used as starting state. The reason is, that, when starting from a non realistic state (e.g. all windows closed), the Markov process takes some time to reach a realistic behavior. That way, even the first simulated days could be compared to the real data.

From these six rebuilt schedules, some statistics were calculated and compared with the same statistics extracted from the measured schedule. These comparisons are presented below.

##### 4.4.2. Average duration of the openings

Table 4.3 presents the number of 10 minutes time intervals during which the windows and doors are open, as well for the 6 calculated behaviors as for the measured one. It can immediately be seen that the average synthetic behavior is close to the measured behavior, except maybe for the window 13, in which a relative difference of more than 30 % is observed.  $\chi^2$  test, however, is not passed, even with a low probability.

**Table 4.3:** Number of time intervals during which the window, ( $i = 1$  to 16) is open.

Dwelling	1	2	3	4	5	6	7	8	9	10	11	12	13	14	15	16	sum
Rebuilt 1	154	1	2516	45	33	35	0	14458	10269	54	0	945	1325	5473	2797	0	38105
Rebuilt 2	293	33	2462	37	17	49	0	11766	7095	134	0	624	362	5589	3931	0	32392
Rebuilt 3	210	15	2323	16	38	50	0	12381	8029	48	0	689	1519	5240	3507	0	34065
Rebuilt 4	103	42	2860	5	21	55	0	9400	8805	1	0	826	1519	5120	3423	0	32180
Rebuilt 5	84	17	2785	34	32	22	0	12429	10976	17	0	641	383	5702	2951	0	36073
Rebuilt 6	238	80	3013	64	40	31	0	11217	10539	151	0	975	67	5207	3314	0	34936
Average	180	31	2660	35	30	40	0	11941	9286	68	0	783	863	5388	3316	0	34625
measured	179	28	2532	36	32	60	0	12692	8599	60	0	837	1260	5781	3839	0	35935

The dispersion between the various rebuilt schedules varies with the opening. Large variations are seen in openings 1, 2, 4, 10, and 13 again. These openings are characterized by being seldom changed but changed anyway. In other words, they have many transitions from closed to closed and open to open, but very few (less than 5) transitions from open to closed or closed to open. In particular, window 13 started open and was closed once during the measurements.

In this case, the accuracy of the off-diagonal transition probabilities is poor (since based on a few transitions) and the re-calculated behavior is therefore not very accurate. This limit does not come from the model itself, but from the relatively small number of measurements on which the model is based. A good reproducibility of the total open time is obtained when the number of off-diagonal transitions is either 0 (always closed or open windows) or larger than 10.

This leads us to a first limitation: The complexity of the model should be adapted to the available data. In particular, it has no meaning to prepare detailed Markov matrices with many possibilities of transitions, if

some of the transitions are poorly represented in the available data.

4.4.3. *Number of transitions*

Table 4.4 presents the number of transitions from one state to the other. Here again, there is a good agreement between calculated and experimental data, the largest dispersions being for windows having few changes of state. This small discrepancy also comes from the reason evoked above. In this case,  $\chi^2$  test is passed, with a probability of 97.5 %.

Table 4.4: Number of changes from open to closed or vice-versa, for each window or door (i = 1 to 16).

Dwelling	1	2	3	4	5	6	7	8	9	10	11	12	13	14	15	16	sum
Rebuilt 1	12	2	287	12	40	10	0	26	38	4	0	160	1	152	200	0	943
Rebuilt 2	18	4	277	14	22	12	0	37	29	4	0	148	1	191	240	0	997
Rebuilt 3	25	2	256	10	40	14	0	34	38	2	0	152	1	162	228	0	964
Rebuilt 4	16	6	334	8	26	8	0	25	33	2	0	152	1	143	219	0	973
Rebuilt 5	9	4	340	16	42	12	0	28	45	2	0	138	1	138	223	0	998
Rebuilt 6	20	10	301	28	36	12	0	30	47	4	0	170	1	169	228	0	1056
Average	17	5	299	15	34	11	0	30	38	3	0	153	1	159	223	0	989
measured	14	4	291	16	36	14	0	27	39	2	0	152	1	139	215	0	950

Markov transition matrices were also rebuilt from the calculated data. They were found very similar, when not identical, to the Markov matrices built from the measured data. However, for particular windows like window 13, one rebuilt matrix (for temperature class 3) was purely diagonal, which looks strange, like if the window was closed and open, but without transition. In fact, the only transition was done in another temperature class and such a matrix tells that, for that temperature class, this window remains in the state it was when entering the temperature class.

4.4.4. *Histogram of opening times*

Figure 4.2 shows, always for dwelling 43, histograms of opening times, that is the number of windows open during less than 1 hour, between 1 and 2 hours, etc. up to open more than 16 hours. The front histogram represents the experimental data, the next 6 ones are the 6 re-calculated data and the last one, in the back, is the average of these. This picture shows a good agreement between these data, except for the large opening times, where the algorithm overestimates the number of windows remaining open during more than 16 hours. Therefore, the  $\chi^2$  test is passed only with a probability of 10%.

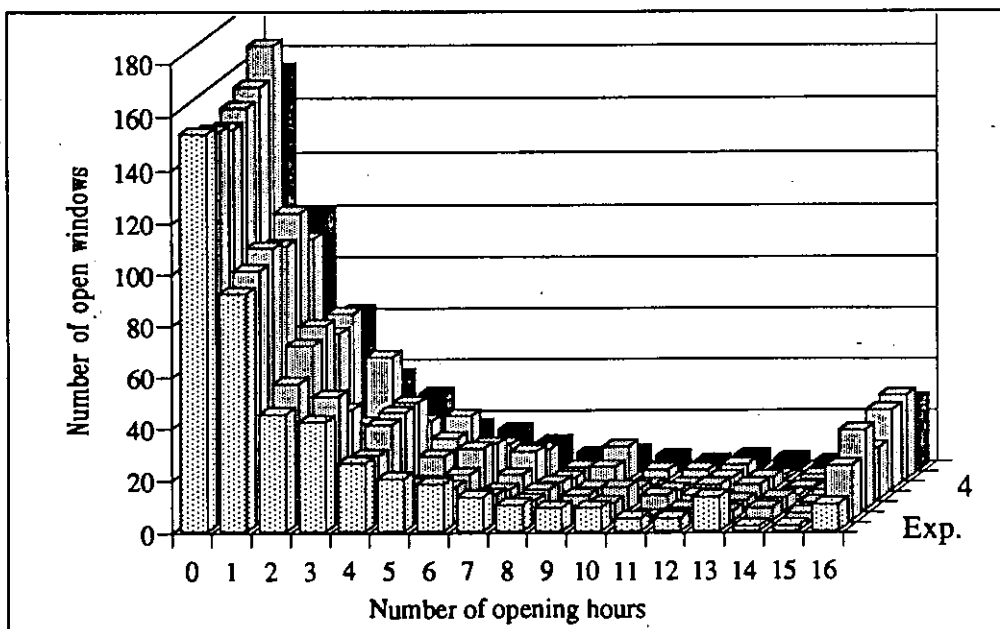

Figure 3: Histograms of opening times for dwelling 43. The experimented data are in front and re-calculated

data are in back. The last histogram in the back is the average of re-calculated data.

#### 4.4.5. Temperature dependence

Probability density function for the number of open windows in dwelling 43 and as a function of the outdoor temperature are presented on Figures 4.4 and 4.5, respectively for the experimental data and for one rebuilt set of data. Both figures show that the number of open windows increases with the outdoor temperature, and that general tendency is hence reproduced by the model.

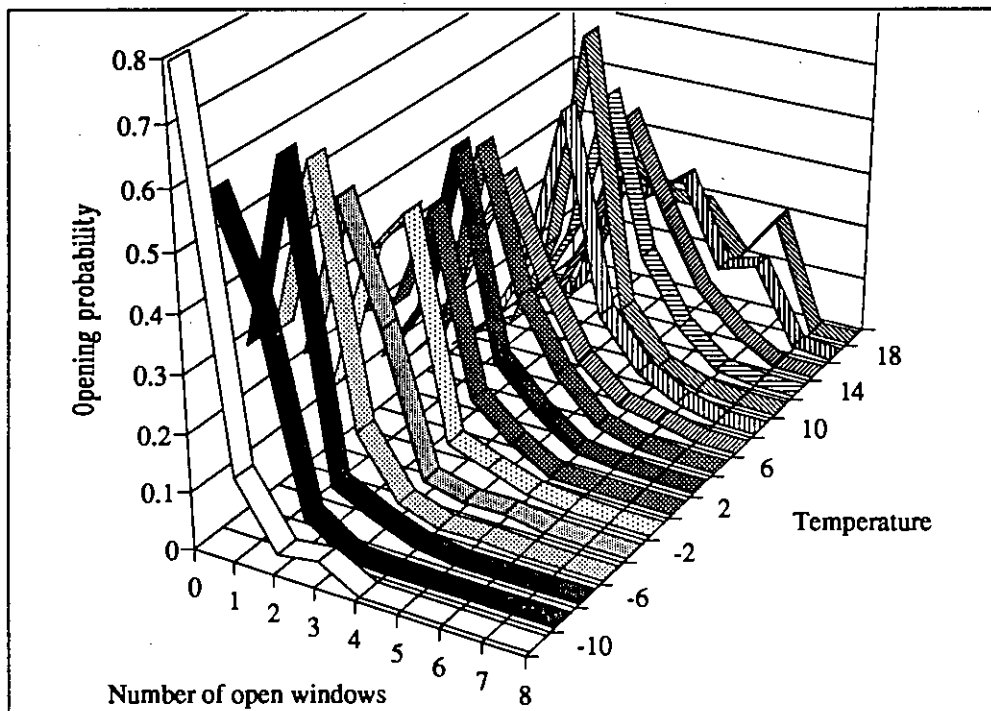

Figure 4.4: Probability density function for the number of open windows as measured in dwelling 43.

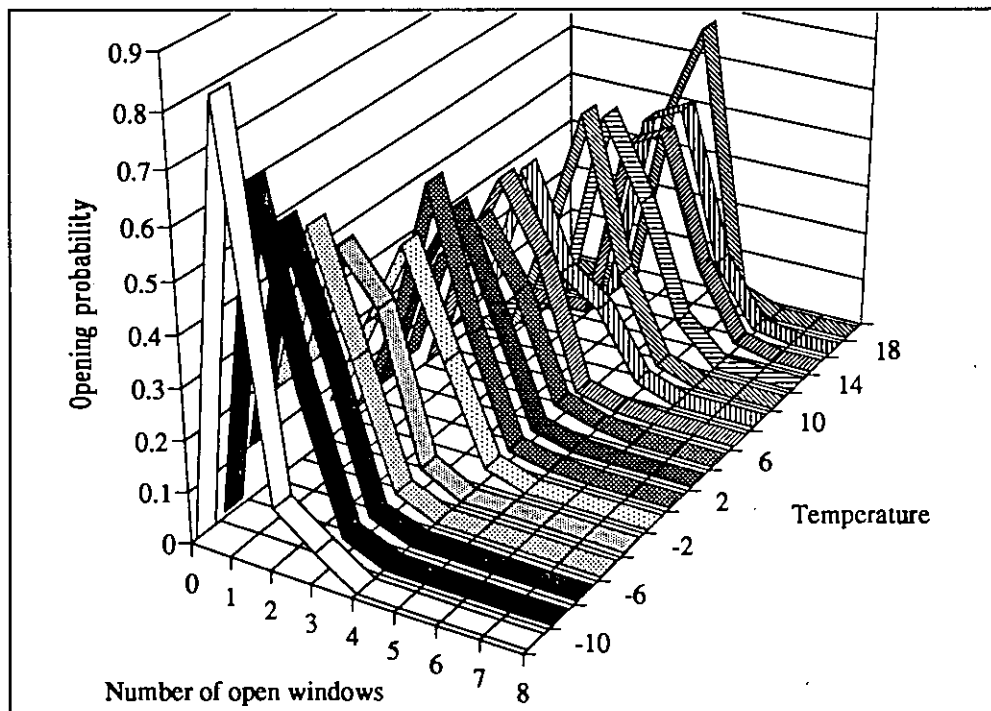

Figure 4.5: Probability density function for the number of open windows for the data rebuilt using the model,

based on measurements on dwelling 43.

However, large differences can be seen at very low and at high temperatures. At low temperatures (less than -6 °C), the algorithms underpredicts the probability to have all the windows closed and, therefore, overpredicts the probability to have one (or more) window open. At high temperatures (more than 12 °C), the model results in a probability density function which is narrower than the measured one. This summer phenomenon was already mentioned by Fritsch et Al. [1990] who have restricted therefore the validity of their model to the heating season.

The small number of samples could also be a cause of that discrepancy. In the 2 degree wide classes which were used for these Figures, the 17000 measurements were inhomogeneously distributed: more than 500 measurements per degree class from -4 up to 8 °C, and 300 or less above 16 and below -6 °C.

**4.4.6. Correlations and variances**

The next stage was the comparison of the inter-correlations calculated from the synthetic and real time series of window openings. These cross correlation between the 16 windows and doors themselves and between these and the outdoor temperature and the number of open windows are shown on Tables 4.5 and 4.6, for the measured and re-calculated data respectively. These tables are symmetric, and on their diagonals are the variances of each opening.

**Table 4.5: Cross-correlations between windows, dwelling 43, Experimental Data. On the diagonal (bold characters) are the variances of each window opening.**

No	1	2	3	4	5	6	7	8	9	10	11	12	13	14	15	16	T <sub>ext</sub>	Sum
1	<b>0.01</b>	0.34	0.12	0.00	0.02	-0.01	0.00	0.03	0.00	-0.01	0.00	0.03	0.05	-0.01	0.07	0.00	-0.01	0.16
2	0.34	<b>0.00</b>	0.06	0.00	0.00	0.00	0.00	-0.07	0.00	0.00	0.00	-0.01	-0.01	-0.03	0.02	0.00	-0.06	0.04
3	0.12	0.06	<b>0.13</b>	0.03	0.07	0.04	0.00	0.09	0.05	-0.02	0.00	0.16	0.02	0.04	0.11	0.00	0.06	0.41
4	0.00	0.00	0.03	<b>0.00</b>	0.00	0.00	0.00	0.01	0.02	0.00	0.00	-0.01	-0.01	-0.01	-0.01	0.00	0.00	0.05
5	0.02	0.00	0.07	0.00	<b>0.00</b>	0.00	0.00	0.02	0.01	0.00	0.00	0.04	0.01	0.01	0.04	0.00	0.02	0.09
6	-0.01	0.00	0.04	0.00	0.00	<b>0.00</b>	0.00	0.03	0.03	0.00	0.00	0.01	0.04	0.05	0.06	0.00	0.03	0.12
7	0.00	0.00	0.00	0.00	0.00	0.00	<b>0.00</b>	0.00	0.00	0.00	0.00	0.00	0.00	0.00	0.00	0.00	0.00	0.00
8	0.03	-0.07	0.09	0.01	0.02	0.03	0.00	<b>0.19</b>	0.36	0.03	0.00	0.00	0.16	0.05	-0.11	0.00	0.16	0.50
9	0.00	0.00	0.05	0.02	0.01	0.03	0.00	0.36	<b>0.25</b>	0.06	0.00	0.08	-0.29	0.30	-0.02	0.00	0.26	0.57
10	-0.01	0.00	-0.02	0.00	0.00	0.00	0.00	0.03	0.06	<b>0.00</b>	0.00	0.02	-0.02	0.01	0.00	0.00	-0.01	0.07
11	0.00	0.00	0.00	0.00	0.00	0.00	0.00	0.00	0.00	0.00	<b>0.00</b>	0.00	0.00	0.00	0.00	0.00	0.00	0.00
12	0.03	-0.01	0.16	-0.01	0.04	0.01	0.00	0.00	0.08	0.02	0.00	<b>0.05</b>	-0.04	0.28	0.37	0.00	0.34	0.45
13	0.05	-0.01	0.02	-0.01	0.01	0.04	0.00	-0.16	-0.29	-0.02	0.00	-0.04	<b>0.07</b>	-0.18	0.03	0.00	-0.01	0.09
14	-0.01	-0.03	0.04	-0.01	0.01	0.05	0.00	0.05	0.30	0.01	0.00	0.28	-0.18	<b>0.22</b>	0.44	0.00	0.77	0.64
15	0.07	0.02	0.11	-0.01	0.04	0.06	0.00	-0.11	-0.02	0.00	0.00	0.37	0.03	0.44	<b>0.17</b>	0.00	0.41	0.53
16	0.00	0.00	0.00	0.00	0.00	0.00	0.00	0.00	0.00	0.00	0.00	0.00	0.00	0.00	0.00	<b>0.00</b>	0.00	0.00
T <sub>ext</sub>	-0.01	-0.06	0.06	0.00	0.02	0.03	0.00	0.16	0.26	-0.01	0.00	0.34	-0.01	0.77	0.41	0.00		0.62
Sum	0.16	0.04	0.41	0.05	0.09	0.12	0.00	0.50	0.57	0.07	0.00	0.45	0.09	0.64	0.53	0.00		1.77

**Table 4.6: Cross-correlations, dwelling 43. Rebuilt data**

NNo	1	2	3	4	5	6	7	8	9	10	11	12	13	14	15	16	T <sub>ext</sub>	Sum
1	<b>0.02</b>	-0.01	0.00	-0.01	0.00	-0.01	0.00	-0.01	0.05	-0.01	0.00	-0.03	-0.02	-0.05	0.02	0.00	-0.06	0.00
2	-0.01	<b>0.00</b>	-0.02	0.00	0.00	0.00	0.00	-0.02	-0.04	0.00	0.00	-0.01	-0.01	-0.03	0.03	0.00	-0.08	-0.04
3	0.00	-0.02	<b>0.13</b>	0.01	0.01	0.02	0.00	0.02	0.02	0.00	0.00	0.00	-0.06	0.07	0.02	0.00	0.07	0.23
4	-0.01	0.00	0.01	<b>0.00</b>	0.00	0.00	0.00	0.00	0.02	0.00	0.00	-0.01	-0.01	-0.01	-0.02	0.00	-0.02	0.01
5	0.00	0.00	0.01	0.00	<b>0.00</b>	0.00	0.00	-0.01	-0.01	0.00	0.00	-0.01	0.00	0.01	0.01	0.00	0.01	0.02
6	-0.01	0.00	0.02	0.00	0.00	<b>0.00</b>	0.00	0.03	-0.03	0.00	0.00	-0.01	-0.01	-0.03	0.03	0.00	-0.01	0.04
7	0.00	0.00	0.00	0.00	0.00	0.00	<b>0.00</b>	0.00	0.00	0.00	0.00	0.00	0.00	0.00	0.00	0.00	0.00	0.00
8	-0.01	-0.02	0.02	0.00	-0.01	0.03	0.00	<b>0.21</b>	0.15	-0.12	0.00	-0.03	0.10	-0.12	-0.03	0.00	-0.08	0.25
9	0.05	-0.04	0.02	0.02	-0.01	-0.03	0.00	0.15	<b>0.24</b>	-0.08	0.00	-0.02	-0.13	0.01	0.04	0.00	0.12	0.30
10	-0.01	0.00	0.00	0.00	0.00	0.00	0.00	-0.12	-0.08	<b>0.01</b>	0.00	0.01	-0.01	-0.04	-0.05	0.00	-0.02	-0.02
11	0.00	0.00	0.00	0.00	0.00	0.00	0.00	0.00	0.00	0.00	<b>0.00</b>	0.00	0.00	0.00	0.00	0.00	0.00	0.00
12	-0.03	-0.01	0.00	-0.01	-0.01	-0.01	0.00	-0.03	-0.02	0.01	0.00	<b>0.04</b>	-0.03	0.19	0.13	0.00	0.22	0.26
13	-0.02	-0.01	-0.06	-0.01	0.00	-0.01	0.00	0.10	-0.13	-0.01	0.00	-0.03	<b>0.02</b>	-0.09	-0.08	0.00	-0.02	0.05
14	-0.05	-0.03	0.07	-0.01	0.01	-0.03	0.00	-0.12	0.01	-0.04	0.00	0.19	-0.09	<b>0.22</b>	0.27	0.00	0.69	0.56
15	0.02	0.03	0.02	-0.02	0.01	0.03	0.00	-0.03	0.04	-0.05	0.00	0.13	-0.08	0.27	<b>0.18</b>	0.00	0.33	0.45
16	0.00	0.00	0.00	0.00	0.00	0.00	0.00	0.00	0.00	0.00	0.00	0.00	0.00	0.00	0.00	<b>0.00</b>	0.00	0.00
T <sub>ext</sub>	-0.06	-0.08	0.07	-0.02	0.01	-0.01	0.00	-0.08	0.12	-0.02	0.00	0.22	-0.02	0.69	0.33	0.00		0.68
Sum	0.00	-0.04	0.23	0.01	0.02	0.04	0.00	0.25	0.30	-0.02	0.00	0.26	0.05	0.56	0.45	0.00		3.95

The variances are very similar and, linking that result with the conclusions from Sections 4.2 to 4.4, one can say that the model reproduces the window openings with the same average opening time, the same average

frequency of changes and the same variance. The slight exception is window 13, which moves only once during the measurement period used.

The cross correlations do not give, as one could expect, good results. First of all, there are correlations or anti-correlations between some windows which cannot be neglected, as is shown in Table 4.5. For example, there are some correlations (about 0.3 or more) between the following windows:

- |                |                                                                           |
|----------------|---------------------------------------------------------------------------|
| 1 and 2:       | fanlights of the gallery-side bedroom,                                    |
| 8 and 9:       | fanlights of a balcony-side bedroom,                                      |
| 12, 14 and 15: | the balcony-side door and two bedroom windows located on the same facade. |

The reason for the first four is quite obvious: these windows are open at the same time, either when going to bed or when waking up. Note that windows 1 and 2 are seldom open when windows 8 and 9 are open 60 to 80% of the time.

Windows 12, 14 and 15 are the most manipulated but the average opening time is relatively low: from 5% for the door 12 up to 34 % for window 14. It seems that they are open every day during a few hours to ventilate the dwelling.

There are also some anti-correlations, for example between the fanlight 8 and the window 15 located just under it. Window 13 also presents anti-correlations with several other windows, but, as already seen, one cannot have much confidence on the results implying the window 13.

The general conclusion of that is that there are some correlations (positive and negative), which may not be the same for every user, but which cannot be neglected. Therefore, the model presented here cannot be perfect, since it is based on independent windows.

This model, however, reproduces some correlations, as it is shown on Table 4.6. For example, openings 12, 14 and 15 as well as fanlights 8 and 9 are also slightly correlated in the reconstructed schedule, but with a lower correlation coefficient. On the other hand, the correlation between windows 1 and 2 disappears completely. These correlations remain because of the deterministic temperature dependence, and does not result from the model itself.

#### 4.4.7. *Time schedule*

The daily time schedule can be reproduced only approximatively by this model, since it can only be introduced in a very rough way: by blocking the opening in their actual state during sleeping hours. In fact, no attempt was made in this direction for the present work, and the comparisons were made between the real time series and a series recalculated without any time-related constraint. Taking account of the real time schedule may give a more realistic result without making the model too complicated.

## 5. Conclusions

Stochastic models, allowing one to re-calculate the window opening for dwellings were developed and based on measurements taken as well in an office building as in a large multi-family building. These simple model requires very few parameters per opening and very simple reconstruction algorithms.

The models are simple. They all assumes that the different doors or windows of a building are independent and refer to basic stochastic processes: pure random process and Markov chains. The outside temperature acts as a driving variable for windows opening or closing, while time of the day drives the internal door openings. The data required for these models are provided for different types of inhabitants, and allow therefore to simulate the effect of various behaviors on the ventilation in dwellings.

A simplified evaluation procedure was conducted on the generated series. The major statistic characteristics were compared and found to be similar, except for the openings with very few changes.

Two opposite limitations were found: on one hand, the model should be simple enough in order to be elaborated from a limited number of experiments. On the other hand, it could be improved to take account of the interactions between openings.

Nevertheless, this model could be implemented in the multizone air infiltration simulation programs. Together with a model calculating the air flow rates through large openings, it will allow to take account of different inhabitant behaviors and to predict their effects on ventilation.

## 6. Acknowledgements

The authors will gratefully thank Hans Phaff (TNO, Delft, NL) for having provided the data measured at the Schiedam building. They also acknowledge to Luk Vandaele (BBRI) and Véronique Richalet (LASH-ENTPE) for having provided data which are unfortunately not yet interpreted, (because of lack of manpower) and therefore not reported here.

This work, performed within the IEA-ECB, Annex 20 research program, is financed by the Swiss Federal Office of Energy (OFEN/BEW, Bern).

## 7. References

- Bartlett, M.S.[1979]: An introduction to stochastic processes: Methods and applications, *Cambridge University Press, Cambridge, UK (1979)*.
- Dubrul, C. [1988]: Inhabitant behavior with respect to ventilation - A summary report of IEA Annex VIII. *Technical note AIVC 23 (1988)*.
- de Gids, W. F.; Phaff, J. C.; van Dongen, J. E. F. and van Schijndel, L. L. M. [1985]: Bewonersgedrag en Ventilatie. *Interim Rapport C 581, July 1985, IMG TNO, Delft (NL)*
- Fewkes, A. and Ferris, S.A, [1982]: The recycling of domestic waste. A study of the factors influencing the storage capacity and the simulation of the usage patterns, *Building and Environment, 17 N° 3 (1982)*.
- Fritsch, R., Kohler, A., Nygård Ferguson, M and Scartezzini, J.-L.: Stochastic Model of Users Behavior In Regard to Ventilation. *Buildings and Environment 25, pp 173-181, 1990*
- Harrje, D. T. and Piggins, J. [1991]: Reporting Guidelines for the Measurement of Airflows and Related Factors in Buildings. *Technical Note AIVC No 32, 1991*. A detailed description of the LESO building is given pp 103-145.
- Kemeny, J. B. and Snell, J. L. [1976]: Finite Markov Chains. *Springer, New York, 1976*.
- Liddament, M. [1986]: Air Infiltration Calculation Techniques - An Applications Guide. *Air Infiltration and Ventilation Centre, 1986*
- Phaff, J. C. [1986]: Effect of Instructions to Inhabitants on their Behavior. *Supplement to Proceedings of the 7th AIVC Conference, Stratford-upon-Avon, 1986, pp 55-66*.
- Roulet, C.-A., Cretton, P., Fritsch, R., and Scartezzini, J.-L. [1991]: Stochastic Model of Inhabitant Behavior In Regard to Ventilation. *Proceedings of the 12th AIVC Conference, Ottawa, 1991*.
- Scartezzini, J.-L. Fritsch, R., Kohler, A., and Nygård Ferguson, M; [1990]: Etude Stochastique du Comportement de l'Occupant. *Rapport final NEFF 339.5, LESO-EPFL, CH 1015 Lausanne, 1990*.
- Scartezzini, J.-L., Faist, A. and Gay, J.-B.; [1987]: Experimental Comparisons of a Sunspace and a Water Hybrid Solar Device Using the LESO Test Facility. *Solar Energy 38, pp 355-366, 1987*.
- Scartezzini, J.-L., Roecker, Ch., Quévit, D.; [1985]: Continuous Air Renewal Measurements in an Occupied Solar Office Building. *Clima 2000 Proceedings, Zurich, 1985*.
- van Dongen, J. E. F. [1986]: Inhabitants Behavior with Respect to Ventilation. *Supplement to Proceedings of the 7th AIVC Conference, Stratford-upon-Avon, 1986, pp 67-90*.
- Warren, P.R. [1978]: Ventilation through openings on one wall only, p. 189. *Energy Conservation in Heating, Cooling and Ventilating Building. Hemisphere Publ. Corp. Washington (1978)*.

### 8. Appendix 1: Probability Distribution Functions for Door Opening

Office with 2 occupants

Number of door openings during 30 minutes	Measured probability			
	Very low activity	Low activity	Average activity	High activityy
0	0.6000.	0.5376.	0.2542.	0.2488.
1	0.2000.	0.0833.	0.0833.	0.0750.
2	0.1000.	0.1083.	0.1625.	0.0869.
3	0.0500.	0.0833.	0.1750.	0.1012.
4	0.0500.	0.0750.	0.1375.	0.1119.
5	0	0.0333.	0.0542.	0.0857.
6	0	0.0333.	0.0542.	0.0762.
7	0	0.0167.	0.0375.	0.0570.
8	0	0.0125.	0.0083.	0.0500.
9	0	0.0042.	0.0083.	0.0286.
10	0	0	0.0083.	0.0226.
11	0	0.0083.	0.0042.	0.0131.
12	0	0	0.0083.	0.0095.
13	0	0.0042.	0	0.0107.
14	0	0	0.0042.	0.0131.
15 and more	0	0	0	0.0095.

Office with one occupant

Number of door openings during 30 minutes	Measured probability			
	Very low activity	Low activity	Average activity	High activityy
0	0.6583.	0.4500.	0.2767.	0.1859.
1	0.1168.	0.1389.	0.1567.	0.1090.
2	0.0833.	0.1722.	0.1900.	0.1308.
3	0.0833.	0.0944.	0.1332.	0.1167.
4	0.0167.	0.0389.	0.0900.	0.1026.
5	83.	0.0444.	0.0400.	0.0987.
6	0.0333.	0.0389.	0.0467.	0.0897.
7	0	0.0167.	0.0200.	0.0410.
8	0	55.	0.0233.	0.0462.
9	0	0	0.0067.	0.0218.
10	0	0	0	0.0128.
11	0	0	0.0067.	0.0128.
12	0	0	0	0.0103.
13	0	0	0.0033.	0.0051.
14	0	0	0	0.0026.
15 and more	0	0	0.0067.	0.0140.



**9. Appendix 2: Markov Matrices of Transition Probabilities- Window Opening Angles**

Office GDIR - east      Temperatures -23 to 0°C

Angle before	after	Closed	[1,15[	[15, 35[	[35, 60[	[60, 90[	[90, +∞[
Closed		9108.10 <sup>-4</sup>	724.10 <sup>-4</sup>	120.10 <sup>-4</sup>	48.10 <sup>-4</sup>	0	0
[1, 15[		6667.10 <sup>-4</sup>	1818.10 <sup>-4</sup>	1212.10 <sup>-4</sup>	303.10 <sup>-4</sup>	0	0
[15, 35[		7778.10 <sup>-4</sup>	1111.10 <sup>-4</sup>	1111.10 <sup>-4</sup>	0	0	0
[35, 60[		5000.10 <sup>-4</sup>	5000.10 <sup>-4</sup>	0	0	0	0
[60, 90[		.	.	.	.	.	.
[90, +∞[		These angles were never reached.					

Office GDIR - east      Temperatures 0 to 8°C

Angle before	after	Closed	[1,15[	[15, 35[	[35, 60[	[60, 90[	[90, +∞[
Closed		8539.10 <sup>-4</sup>	985.10 <sup>-4</sup>	285.10 <sup>-4</sup>	156.10 <sup>-4</sup>	35.10 <sup>-4</sup>	0
[1, 15[		7311.10 <sup>-4</sup>	1103.10 <sup>-4</sup>	1172.10 <sup>-4</sup>	345.10 <sup>-4</sup>	69.10 <sup>-4</sup>	0
[15, 35[		5161.10 <sup>-4</sup>	1774.10 <sup>-4</sup>	1129.10 <sup>-4</sup>	968.10 <sup>-4</sup>	968.10 <sup>-4</sup>	0
[35, 60[		3056.10 <sup>-4</sup>	2778.10 <sup>-4</sup>	833.10 <sup>-4</sup>	1944.10 <sup>-4</sup>	1389.10 <sup>-4</sup>	0
[60, 90[		2857.10 <sup>-4</sup>	357.10 <sup>-4</sup>	1429.10 <sup>-4</sup>	357.10 <sup>-4</sup>	5000.10 <sup>-4</sup>	0
[90, +∞[		This angle was never reached.					

Office GDIR - east      Temperatures 8 to 16°C

Angle before	after	Closed	[1,15[	[15, 35[	[35, 60[	[60, 90[	[90, +∞[
Closed		8073.10 <sup>-4</sup>	926.10 <sup>-4</sup>	441.10 <sup>-4</sup>	294.10 <sup>-4</sup>	222.10 <sup>-4</sup>	44.10 <sup>-4</sup>
[1, 15[		5688.10 <sup>-4</sup>	2202.10 <sup>-4</sup>	1101.10 <sup>-4</sup>	459.10 <sup>-4</sup>	550.10 <sup>-4</sup>	0
[15, 35[		3721.10 <sup>-4</sup>	1395.10 <sup>-4</sup>	3373.10 <sup>-4</sup>	581.10 <sup>-4</sup>	930.10 <sup>-4</sup>	0
[35, 60[		1852.10 <sup>-4</sup>	555.10 <sup>-4</sup>	1852.10 <sup>-4</sup>	3519.10 <sup>-4</sup>	2222.10 <sup>-4</sup>	0
[60, 90[		1624.10 <sup>-4</sup>	598.10 <sup>-4</sup>	513.10 <sup>-4</sup>	427.10 <sup>-4</sup>	6753.10 <sup>-4</sup>	85.10 <sup>-4</sup>
[90, +∞[		1667.10 <sup>-4</sup>	0	0	1667.10 <sup>-4</sup>	1667.10 <sup>-4</sup>	4999.10 <sup>-4</sup>

Office GDIR - east      Temperatures 16 to ∞ °C

Angle before	after	Closed	[1,15[	[15, 35[	[35, 60[	[60, 90[	[90, +∞[
Closed		8889.10 <sup>-4</sup>	235.10 <sup>-4</sup>	409.10 <sup>-4</sup>	175.10 <sup>-4</sup>	292.10 <sup>-4</sup>	0
[1, 15[		4118.10 <sup>-4</sup>	4118.10 <sup>-4</sup>	0	588.10 <sup>-4</sup>	1176.10 <sup>-4</sup>	0
[15, 35[		1481.10 <sup>-4</sup>	1852.10 <sup>-4</sup>	5556.10 <sup>-4</sup>	1111.10 <sup>-4</sup>	0	0
[35, 60[		1905.10 <sup>-4</sup>	952.10 <sup>-4</sup>	1905.10 <sup>-4</sup>	2857.10 <sup>-4</sup>	2381.10 <sup>-4</sup>	0
[60, 90[		1990.10 <sup>-4</sup>	0	161.10 <sup>-4</sup>	1129.10 <sup>-4</sup>	7097.10 <sup>-4</sup>	323.10 <sup>-4</sup>
[90, +∞[		0	0	0	0	714.10 <sup>-4</sup>	9286.10 <sup>-4</sup>

Office GDIR - west      Temperatures -273 to 0°C

Angle before	after	Closed	[1,15[	[15,35[	[35,60[	[60,90[	[90,+∞[
Closed		9754.10 <sup>-4</sup>	201.10 <sup>-4</sup>	45.10 <sup>-4</sup>	0	0	0
[1,15[		9000.10 <sup>-4</sup>	1000.10 <sup>-4</sup>	0	0	0	0
[15,35[		1	0	0	0	0	0
[35,60[							
[60,90[							
[90,+∞[							

These angles were never reached.

Office GDIR - west      Temperatures 0 to 8°C

Angle before	after	Closed	[1,15[	[15,35[	[35,60[	[60,90[	[90,+∞[
Closed		9288.10 <sup>-4</sup>	428.10 <sup>-4</sup>	207.10 <sup>-4</sup>	69.10 <sup>-4</sup>	8.10 <sup>-4</sup>	0
[1,15[		7403.10 <sup>-4</sup>	2078.10 <sup>-4</sup>	519.10 <sup>-4</sup>	0	0	0
[15,35[		6286.10 <sup>-4</sup>	1714.10 <sup>-4</sup>	1143.10 <sup>-4</sup>	286.10 <sup>-4</sup>	571.10 <sup>-4</sup>	0
[35,60[		3333.10 <sup>-4</sup>	5000.10 <sup>-4</sup>	0	1667.10 <sup>-4</sup>	0	0
[60,90[		3333.10 <sup>-4</sup>	6667.10 <sup>-4</sup>	0	0	0	0
[90,+∞[							

This angle was never reached.

Office GDIR - west      Temperatures 8 to 16°C

Angle before	after	Closed	[1,15[	[15,35[	[35,60[	[60,90[	[90,+∞[
Closed		8805.10 <sup>-4</sup>	524.10 <sup>-4</sup>	342.10 <sup>-4</sup>	207.10 <sup>-4</sup>	98.10 <sup>-4</sup>	24.10 <sup>-4</sup>
[1,15[		5476.10 <sup>-4</sup>	2381.10 <sup>-4</sup>	715.10 <sup>-4</sup>	833.10 <sup>-4</sup>	119.10 <sup>-4</sup>	476.10 <sup>-4</sup>
[15,35[		4000.10 <sup>-4</sup>	2222.10 <sup>-4</sup>	1333.10 <sup>-4</sup>	1333.10 <sup>-4</sup>	667.10 <sup>-4</sup>	445.10 <sup>-4</sup>
[35,60[		3393.10 <sup>-4</sup>	1429.10 <sup>-4</sup>	893.10 <sup>-4</sup>	3393.10 <sup>-4</sup>	536.10 <sup>-4</sup>	356.10 <sup>-4</sup>
[60,90[		1304.10 <sup>-4</sup>	1304.10 <sup>-4</sup>	435.10 <sup>-4</sup>	870.10 <sup>-4</sup>	6087.10 <sup>-4</sup>	0
[90,+∞[		2083.10 <sup>-4</sup>	0	0	2083.10 <sup>-4</sup>	417.10 <sup>-4</sup>	5417.10 <sup>-4</sup>

Office GDIR - west      Temperatures 16 to ∞ °C

Angle before	after	Closed	[1,15[	[15,35[	[35,60[	[60,90[	[90,+∞[
Closed		9220.10 <sup>-4</sup>	92.10 <sup>-4</sup>	229.10 <sup>-4</sup>	138.10 <sup>-4</sup>	229.10 <sup>-4</sup>	92.10 <sup>-4</sup>
[1,15[		3334.10 <sup>-4</sup>	2222.10 <sup>-4</sup>	0	2222.10 <sup>-4</sup>	2222.10 <sup>-4</sup>	0
[15,35[		4999.10 <sup>-4</sup>	1667.10 <sup>-4</sup>	1667.10 <sup>-4</sup>	0	1667.10 <sup>-4</sup>	0
[35,60[		3636.10 <sup>-4</sup>	0	909.10 <sup>-4</sup>	5000.10 <sup>-4</sup>	455.10 <sup>-4</sup>	0
[60,90[		1176.10 <sup>-4</sup>	392.10 <sup>-4</sup>	392.10 <sup>-4</sup>	588.10 <sup>-4</sup>	7452.10 <sup>-4</sup>	0
[90,+∞[							

Angle never reached

Office HIT-east Temperatures -273 to 0°C

Angle before	after	Closed	[1,15[	[15,35[	[35,60[	[60,90[	[90,+∞[
Closed		9961.10 <sup>-4</sup>	39.10 <sup>-4</sup>	0	0	0	0
[1,15[							
[15,35[							
[35,60[							
[60,90[							
[90,+∞[							

These angles were never reached.

Office HIT-east Temperatures 0 to 8°C

Angle before	after	Closed	[1,15[	[15,35[	[35,60[	[60,90[	[90,+∞[
Closed		9956.10 <sup>-4</sup>	38.10 <sup>-4</sup>	6.10 <sup>-4</sup>	0	0	0
[1,15[		7500.10 <sup>-4</sup>	2500.10 <sup>-4</sup>	0	0	0	0
[15,35[		0	1	0	0	0	0
[35,60[							
[60,90[							
[90,+∞[							

These angles were never reached.

Office HIT-east Temperatures 8 to 16°C

Angle before	after	Closed	[1,15[	[15,35[	[35,60[	[60,90[	[90,+∞[
Closed		9891.10 <sup>-4</sup>	59.10 <sup>-4</sup>	40.10 <sup>-4</sup>	10.10 <sup>-4</sup>	0	0
[1,15[		4667.10 <sup>-4</sup>	5333.10 <sup>-4</sup>	0	0	0	0
[15,35[		7500.10 <sup>-4</sup>	2500.10 <sup>-4</sup>	0	0	0	0
[35,60[		0	1	0	0	0	0
[60,90[							
[90,+∞[							

These angles were never reached.

Office HIT-east Temperatures 16 to ∞ °C

Angle before	after	Closed	[1,15[	[15,35[	[35,60[	[60,90[	[90,+∞[
Closed		9682.10 <sup>-4</sup>	127.10 <sup>-4</sup>	64.10 <sup>-4</sup>	127.10 <sup>-4</sup>	0	0
[1,15[		1905.10 <sup>-4</sup>	8095.10 <sup>-4</sup>	0	0	0	0
[15,35[		5000.10 <sup>-4</sup>	0	0	5000.10 <sup>-4</sup>	0	0
[35,60[		0	1111.10 <sup>-4</sup>	1111.10 <sup>-4</sup>	7778.10 <sup>-4</sup>	0	0
[60,90[							
[90,+∞[							

These angles were never reached.

Office HIT-west Temperatures -273 to 0°C

Angle before	after	Closed	[1,15[	[15, 35[	[35, 60[	[60, 90[	[90, +∞[
Closed		9719.10 <sup>-4</sup>	241.10 <sup>-4</sup>	40.10 <sup>-4</sup>	0	0	0
[1, 15[		1111.10 <sup>-4</sup>	8889.10 <sup>-4</sup>	0	0	0	0
[15, 35[		1	0	0	0	0	0
[35, 60[		These angles were never reached.					
[60, 90[		These angles were never reached.					
[90, +∞[		These angles were never reached.					

Office HIT-west Temperatures 0 to 8°C

Angle before	after	Closed	[1,15[	[15, 35[	[35, 60[	[60, 90[	[90, +∞[
Closed		9756.10 <sup>-4</sup>	193.10 <sup>-4</sup>	51.10 <sup>-4</sup>	0	0	0
[1, 15[		7297.10 <sup>-4</sup>	1892.10 <sup>-4</sup>	541.10 <sup>-4</sup>	270.10 <sup>-4</sup>	0	0
[15, 35[		5000.10 <sup>-4</sup>	3334.10 <sup>-4</sup>	833.10 <sup>-4</sup>	833.10 <sup>-4</sup>	0	0
[35, 60[		0	5000.10 <sup>-4</sup>	5000.10 <sup>-4</sup>	0	0	0
[60, 90[		These angles were never reached.					
[90, +∞[		These angles were never reached.					

Office HIT-west Temperatures 8 to 16°C

Angle before	after	Closed	[1,15[	[15, 35[	[35, 60[	[60, 90[	[90, +∞[
Closed		9571.10 <sup>-4</sup>	354.10 <sup>-4</sup>	54.10 <sup>-4</sup>	21.10 <sup>-4</sup>	0	0
[1, 15[		5345.10 <sup>-4</sup>	2759.10 <sup>-4</sup>	1206.10 <sup>-4</sup>	690.10 <sup>-4</sup>	0	0
[15, 35[		2308.10 <sup>-4</sup>	1923.10 <sup>-4</sup>	5000.10 <sup>-4</sup>	769.10 <sup>-4</sup>	0	0
[35, 60[		2222.10 <sup>-4</sup>	2222.10 <sup>-4</sup>	1111.10 <sup>-4</sup>	4445.10 <sup>-4</sup>	0	0
[60, 90[		These angles were never reached.					
[90, +∞[		These angles were never reached.					

Office HIT-west Temperatures 16 to ∞ °C

Angle before	after	Closed	[1,15[	[15, 35[	[35, 60[	[60, 90[	[90, +∞[
Closed		9355.10 <sup>-4</sup>	242.10 <sup>-4</sup>	403.10 <sup>-4</sup>	0	0	0
[1, 15[		5000.10 <sup>-4</sup>	3750.10 <sup>-4</sup>	1250.10 <sup>-4</sup>	0	0	0
[15, 35[		5000.10 <sup>-4</sup>	0	1250.10 <sup>-4</sup>	3750.10 <sup>-4</sup>	0	0
[35, 60[		208.10 <sup>-4</sup>	626.10 <sup>-4</sup>	208.10 <sup>-4</sup>	8958.10 <sup>-4</sup>	0	0
[60, 90[		These angles were never reached.					
[90, +∞[		These angles were never reached.					

### 10. Appendix 3: Markov Matrices of Transition Probabilities, Window Opening Model

Table A3.1: Dwelling No 1: "Average user, with least square deviation to the global average.

Window Number	Temperature class [°C]							
	[-273-0]		]0-8]		]8-16]		]16-μ[	
1	0.9921	0.0079	0.9911	0.0089	0.9885	0.0115	0.984	0.016
	0.0275	0.9725	0.032	0.968	0.0183	0.9817	0.0018	0.9982
2	1	0	1	0	1	0	1	0
	1	0	1	0	1	0	1	0
3	0.989	0.011	0.9861	0.0139	0.9842	0.0158	0.9713	0.0287
	0.0865	0.9135	0.1123	0.8877	0.0424	0.9576	0.0129	0.9871
4	1	0	0.9999	0.0001	0.9998	0.0002	0.9933	0.0067
	1	0	1	0	0.2308	0.7692	0.1538	0.8462
5	1	0	0.9997	0.0003	0.9986	0.0014	0.9909	0.0091
	1	0	1	0	0.4	0.6	0.2637	0.7363
6	0.9996	0.0004	0.9991	0.0009	0.9993	0.0007	0.997	0.003
	1	0	0.0968	0.9032	0.25	0.75	0.0376	0.9624
7	1	0	1	0	1	0	1	0
	1	0	1	0	1	0	1	0
8	0.9926	0.0074	0.9904	0.0096	0.9855	0.0145	0.9773	0.0227
	0.0818	0.9182	0.0102	0.9898	0.0043	0.9957	0.0004	0.9996
9	1	0	1	0	1	0	1	0
	1	0	1	0	1	0	1	0
10	0.9993	0.0007	0.9985	0.0015	0.9966	0.0034	0.9934	0.0066
	0.3333	0.6667	0.1831	0.8169	0.0079	0.9921	0.008	0.992
11	1	0	1	0	0.9973	0.0027	0.9953	0.0047
	1	0	1	0	0.0578	0.9422	0.0896	0.9104
12	1	0	0.9973	0.0027	0.9926	0.0074	0.9634	0.0366
	1	0	0.3333	0.6667	0.1965	0.8035	0.071	0.929
13	0.9989	0.0011	0.9963	0.0037	0.9944	0.0056	0.9981	0.0019
	0.125	0.875	0.0368	0.9632	0.01	0.99	0.0086	0.9914
14	0.9996	0.0004	0.9995	0.0005	0.9953	0.0047	0.9901	0.0099
	1	0	0.0781	0.9219	0.0305	0.9695	0.0148	0.9852
15	0.9996	0.0004	0.9982	0.0018	0.9935	0.0065	0.9756	0.0244
	0.1429	0.8571	0.0522	0.9478	0.0439	0.9561	0.0147	0.9853
16	1	0	1	0	1	0	1	0
	1	0	1	0	1	0	1	0

Table A 3.2: Markov matrices of transition probabilities.Dwelling No 2 (Closed User)

Window Number	Temperature class [°C]							
	[-273-0]		]0-8]		]8-16]		]16-∞[	
1	0.9984	0.0016	0.9974	0.0026	0.9942	0.0058	0.9941	0.0059
	0.0139	0.9861	0.0087	0.9913	0.0041	0.9959	0.0054	0.9946
2	1	0	1	0	0.998	0.002	1	0
	1	0	0.0036	0.9964	0.0004	0.9996	0.0004	0.9996
3	0.9989	0.0011	0.9974	0.0026	0.995	0.005	0.9877	0.0123
	0.0254	0.9746	0.0191	0.9809	0.0196	0.9804	0.0354	0.9646
4	0.9996	0.0004	0.9988	0.0012	0.9956	0.0044	0.9947	0.0053
	1	0	0.2326	0.7674	0.1667	0.8333	0.2245	0.7755
5	0.9989	0.0011	0.9991	0.0009	0.9986	0.0014	0.9968	0.0032
	1	0	0.2	0.8	0.5	0.5	0.36	0.64
6	0.9972	0.0028	0.9986	0.0014	0.9988	0.0012	0.9987	0.0013
	0.0272	0.9728	0.0179	0.9821	0.0281	0.9719	0.013	0.987
7	1	0	1	0	1	0	1	0
	1	0	1	0	1	0	1	0
8	0.9992	0.0008	0.9988	0.0012	0.9997	0.0003	0.9983	0.0017
	0.0254	0.9746	0.0125	0.9875	0.0022	0.9978	0.0008	0.9992
9	1	0	1	0	0.9998	0.0002	1	0
	1	0	0.004	0.996	0	1	1	0
10	0.9996	0.0004	1	0	1	0	1	0
	1	0	1	0	1	0	1	0
11	1	0	1	0	1	0	1	0
	1	0	1	0	1	0	1	0
12	1	0	0.9973	0.0027	0.9921	0.0079	0.9762	0.0238
	1	0	0.2564	0.7436	0.0779	0.9221	0.0139	0.9861
13	0.9996	0.0004	0.9997	0.0003	1	0	0.9985	0.0015
	0.1429	0.8571	0.0161	0.9839	0	1	0.0006	0.9994
14	0.9993	0.0007	0.9979	0.0021	0.9947	0.0053	0.9937	0.0063
	0.1429	0.8571	0.0442	0.9558	0.0232	0.9768	0.0105	0.9895
15	1	0	0.9984	0.0016	0.9959	0.0041	0.9944	0.0056
	0.3333	0.6667	0.0254	0.9746	0.0405	0.9595	0.0293	0.9707
16	1	0	0.9999	0.0001	1	0	0.9982	0.0018
	1	0	0.0023	0.9977	0.0426	0.9574	0.0004	0.9996

Table A3.3: Markov matrices of transition probabilities. Dwelling No 41 (Open User).

Window Number	Temperature class [°C]							
	[-273-0]		]0-8]		]8-16]		]16-∞[	
1	1	0	1	0	0.997	0.003	1	0
	0.0278	0.9722	0	1	0.0004	0.9996	0.0043	0.9957
2	0	1	0.6667	0.3333	0	1	0	1
	0	1	0.0001	0.9999	0	1	0	1
3	0.9736	0.0264	0.9789	0.0211	0.9768	0.0232	0.9629	0.0371
	0.0016	0.9984	0.0153	0.9847	0.0144	0.9856	0.0042	0.9958
4	0.9996	0.0004	0.9999	0.0001	1	0	0.9971	0.0029
	1	0	1	0	1	0	0.1321	0.8679
5	1	0	0.9993	0.0007	0.9993	0.0007	0.9976	0.0024
	1	0	0.3846	0.6154	0.6667	0.3333	0.875	0.125
6	1	0	1	0	0.9998	0.0002	1	0
	1	0	1	0	0.1111	0.8889	1	0
7	1	0	1	0	1	0	1	0
	1	0	1	0	1	0	1	0
8	0	1	0	1	0	1	0	1
	0	1	0	1	0	1	0	1
9	0.998	0.002	0.9995	0.0005	0.9997	0.0003	1	0
	0.0072	0.9928	0.0006	0.9994	0.0014	0.9986	1	0
10	0.9855	0.0145	0.9961	0.0039	0.9995	0.0005	0.9977	0.0023
	0.0004	0.9996	0.0014	0.9986	0.0022	0.9978	0.0006	0.9994
11	1	0	1	0	1	0	1	0
	1	0	1	0	1	0	1	0
12	0.9985	0.0015	0.9921	0.0079	0.9887	0.0113	0.9655	0.0345
	0.0519	0.9481	0.033	0.967	0.0099	0.9901	0.0085	0.9915
13	0.997	0.003	0.9842	0.0158	0	1	0	1
	0.0008	0.9992	0.0007	0.9993	0	1	0	1
14	0	1	0	1	0	1	0	1
	0	1	0	1	0	1	0	1
15	0.9981	0.0019	0.9964	0.0036	0.9927	0.0073	0.9994	0.0006
	0.0005	0.9995	0.0031	0.9969	0.0028	0.9972	0.0023	0.9977
16	0.9992	0.0008	0.9987	0.0013	0.9995	0.0005	1	0
	0.0348	0.9652	0.0073	0.9927	0.0202	0.9798	1	0

Table A 3.4: Markov matrices of transition probabilities. Dwelling No 43: Total average close to the global average.

Window Number	Temperature class [°C]							
	[-273-0]		]0-8]		]8-16]		]16-∞[	
1	0.9993	0.0007	0.9996	0.0004	0.9995	0.0005	1	0
	0.0435	0.9565	0.0702	0.9298	0.0202	0.9798	1	0
2	0.9996	0.0004	0.9999	0.0001	1	0	1	0
	0.037	0.963	1	0	1	0	1	0
3	0.9924	0.0076	0.9898	0.0102	0.9905	0.0095	0.9859	0.0141
	0.058	0.942	0.0624	0.9376	0.0645	0.9355	0.041	0.959
4	0.9996	0.0004	0.9995	0.0005	0.9998	0.0002	0.9992	0.0008
	0.25	0.75	0.1739	0.8261	1	0	0.25	0.75
5	0.9996	0.0004	0.9988	0.0012	0.9991	0.0009	0.9984	0.0016
	1	0	0.5	0.5	1	0	0.5	0.5
6	1	0	0.9996	0.0004	0.9991	0.0009	1	0
	1	0	0.1667	0.8333	0.1071	0.8929	0.0714	0.9286
7	1	0	1	0	1	0	1	0
	1	0	1	0	1	0	1	0
8	0.9969	0.0031	0.9939	0.0061	1	0	0.9987	0.0013
	0.0035	0.9965	0.0013	0.9987	0.0003	0.9997	0	1
9	0.9956	0.0044	0.9977	0.0023	0.9988	0.0012	0.9987	0.0013
	0.014	0.986	0.0016	0.9984	0.0008	0.9992	0	1
10	1	0	0.9999	0.0001	1	0	1	0
	1	0	0.0167	0.9833	1	0	1	0
11	1	0	1	0	1	0	1	0
	1	0	1	0	1	0	1	0
12	0.9996	0.0004	0.997	0.003	0.9934	0.0066	0.9862	0.0138
	0.3333	0.6667	0.225	0.775	0.1714	0.8286	0.0537	0.9463
13	1	0	1	0	1	0	1	0
	1	0	0.0013	0.9987	0.002	0.998	1	0
14	0.9963	0.0037	0.9926	0.0074	0.995	0.005	0	1
	0.1842	0.8158	0.0679	0.9321	0.0083	0.9917	0	1
15	0.99	0.01	0.9924	0.0076	0.993	0.007	0.9888	0.0112
	0.0772	0.9228	0.0475	0.9525	0.0277	0.9723	0.01	0.99
16	1	0	1	0	1	0	1	0
	1	0	1	0	1	0	1	0



ecbcs bookshop

ANN 20 1991: 2