



State-of-the-art Review

Vol. 2A. Responsive Building Elements

Marco Perino (editor)



International Energy Agency
**Energy Conservation in
Buildings and Community
Systems Programme**

Annex 44 Website: www.civil.aau.dk/Annex44

Foreword

This report resumes and presents the activity done in Subtask A of IEA-ECBCS Annex 44 “Integrating Environmentally Responsive Elements in Buildings” concerning the state of the art review of Responsive Building Elements.

It is based on the contributions from the participating countries.

The publication is an internal Annex report. With a focus on innovative building elements that dynamically respond to changes in climate and user demands, the report describes materials, components and systems that have been tested in laboratories and buildings around the world.

This report is aimed at researchers in the field and gives an overview of how these elements work together with available performance data.

It is hoped, that this report will be helpful for researchers in their search for new solutions to the problem of designing and constructing sustainable buildings.

Marco Perino
Editor

Acknowledgments

The material presented in this publication has been collected and developed within an Annex of the IEA Implementing Agreement Energy Conservation in Buildings and Community Systems, Annex 44 “Integrating Environmentally Responsive Elements in Buildings”.

The report is the result of an international joint effort conducted in 14 countries. All those who have contributed to the project are gratefully acknowledged.

In particular the following researchers actively contributed in collecting information, drafting and editing the State-Of-The-Art Report:

Chapter 2 - AIF - editors:

Fernando Marques da Silva and Jennifer Gosselin

Chapter 2 - AIF - contributors:

Inger Andresen, Øyvind Aschehoug, Teshome Edae Jiru, Matthias Haase, Fariborz Haghighat, Per Heiselberg, Jennifer Gosselin, Riccardo Issoglio, Japan National Committee, Fernando Marques da Silva, Marco Perino, Valentina Serra, Fabio Zanghirella.

Chapter 3 - TM editor:

Jakub Kolarik

Chapter 3 - TM contributors:

Nikolai Artmann, Jan Babiak, Jakub Kolarik, Bjarne Olesen, Mats Sandberg, Dietrich Schmidt, Eva-Lotta Wentzel, Asa Wahlstrom, Yang Lina, Yuguo Li, Pengcheng Xu

Chapter 4 - EC editors:

Fariborz Haghighat

Chapter 4 - EC contributors:

Inger Andresen, Tor Helge Dokka, Fariborz Haghighat, Ryozo Ooka, Jian Zhang

Chapter 5 - DIW editors:

Fariborz Haghighat

Chapter 5 - DIW contributors:

Gérard Guarracino, Fariborz Haghighat, Mohammed Imbabi, Kai Qiu

Chapter 6 - PCM editor:

Paolo Principi

Chapter 6 - PCM contributors:

Marian Hopkowicz, Roberto Fioretti, Paolo Principi

International Energy Agency

The International Energy Agency (IEA) was established in 1974 within the framework of the Organisation for Economic Co-operation and Development (OECD) to implement an international energy programme. A basic aim of the IEA is to foster co-operation among the twenty-four IEA participating countries and to increase energy security through energy conservation, development of alternative energy sources and energy research, development and demonstration (RD&D).

Energy Conservation in Buildings and Community Systems

The IEA sponsors research and development in a number of areas related to energy. The mission of one of those areas, the ECBCS - Energy Conservation for Building and Community Systems Programme, is to facilitate and accelerate the introduction of energy conservation, and environmentally sustainable technologies into healthy buildings and community systems, through innovation and research in decision-making, building assemblies and systems, and commercialisation. The objectives of collaborative work within the ECBCS R&D program are directly derived from the on-going energy and environmental challenges facing IEA countries in the area of construction, energy market and research. ECBCS addresses major challenges and takes advantage of opportunities in the following areas:

- exploitation of innovation and information technology;
- impact of energy measures on indoor health and usability;
- integration of building energy measures and tools to changes in lifestyles, work environment alternatives, and business environment.

The Executive Committee

Overall control of the program is maintained by an Executive Committee, which not only monitors existing projects but also identifies new areas where collaborative effort may be beneficial. To date the following projects have been initiated by the executive committee on Energy Conservation in Buildings and Community Systems (completed projects are identified by (*)):

- Annex 1: Load Energy Determination of Buildings (*)
- Annex 2: Ekistics and Advanced Community Energy Systems (*)
- Annex 3: Energy Conservation in Residential Buildings (*)
- Annex 4: Glasgow Commercial Building Monitoring (*)
- Annex 5: Air Infiltration and Ventilation Centre
- Annex 6: Energy Systems and Design of Communities (*)
- Annex 7: Local Government Energy Planning (*)
- Annex 8: Inhabitants Behaviour with Regard to Ventilation (*)
- Annex 9: Minimum Ventilation Rates (*)
- Annex 10: Building HVAC System Simulation (*)
- Annex 11: Energy Auditing (*)
- Annex 12: Windows and Fenestration (*)
- Annex 13: Energy Management in Hospitals (*)
- Annex 14: Condensation and Energy (*)
- Annex 15: Energy Efficiency in Schools (*)
- Annex 16: BEMS 1- User Interfaces and System Integration (*)
- Annex 17: BEMS 2- Evaluation and Emulation Techniques (*)
- Annex 18: Demand Controlled Ventilation Systems (*)

- Annex 19: Low Slope Roof Systems (*)
- Annex 20: Air Flow Patterns within Buildings (*)
- Annex 21: Thermal Modelling (*)
- Annex 22: Energy Efficient Communities (*)
- Annex 23: Multi Zone Air Flow Modelling (COMIS) (*)
- Annex 24: Heat, Air and Moisture Transfer in Envelopes (*)
- Annex 25: Real time HEVAC Simulation (*)
- Annex 26: Energy Efficient Ventilation of Large Enclosures (*)
- Annex 27: Evaluation and Demonstration of Domestic Ventilation Systems (*)
- Annex 28: Low Energy Cooling Systems (*)
- Annex 29: Daylight in Buildings (*)
- Annex 30: Bringing Simulation to Application (*)
- Annex 31: Energy-Related Environmental Impact of Buildings (*)
- Annex 32: Integral Building Envelope Performance Assessment (*)
- Annex 33: Advanced Local Energy Planning (*)
- Annex 34: Computer-Aided Evaluation of HVAC System Performance (*)
- Annex 35: Design of Energy Efficient Hybrid Ventilation (HYBVENT) (*)
- Annex 36: Retrofitting of Educational Buildings (*)
- Annex 37: Low-exergy Systems for Heating and Cooling of Buildings (LowEx) (*)
- Annex 38: Solar Sustainable Housing (*)
- Annex 39: High Performance Insulation Systems (*)
- Annex 40: Building Commissioning to Improve Energy Performance (*)
- Annex 41: Whole Building Heat, Air and Moisture Response (MOIST-ENG)
- Annex 42: The Simulation of Building-Integrated Fuel Cell and Other Cogeneration Systems (FC+COGEN-SIM)
- Annex 43: Testing and Validation of Building Energy Simulation Tools
- Annex 44: Integrating Environmentally Responsive Elements in Buildings
- Annex 45: Energy Efficient Electric Lighting for Buildings
- Annex 46: Holistic Assessment Tool-kit on Energy Efficient Retrofit Measures for Government Buildings (EnERGo)
- Annex 47: Cost-Effective Commissioning for Existing and Low Energy Buildings
- Annex 48: Heat Pumping and Reversible Air Conditioning
- Annex 49: Low Exergy Systems for High Performance Built Environments and Communities
- Annex 50: Prefabricated Systems for Low Energy / High Comfort Building Renewal

Working Group - Energy Efficiency in Educational Buildings (*)

Working Group - Indicators of Energy Efficiency in Cold Climate Buildings (*)

Working Group - Annex 36 Extension: The Energy Concept Adviser (*)

(*) - Completed

Participants

Austria

AEE INTEC

Ernst Blümel

Phone: + 43 3112 5886 25

E-mail: e.bluemel@aee.at

Canada

Concordia University

Fariborz Haghighat

Phone: + 1 514 848 2424

E-mail: haghi@bcee.concordia.ca

China

The University of Hong Kong, Dep. of Mech. Eng.

Yuguo Li

Phone: + 852 2859 2625

E-mail: liyig@hku.hk

The University of Hong Kong, Dep. of Architecture

Matthias Haase

Phone: + 852 2241 5839

E-mail: mathaase@hkusua.hku.hk

Denmark, Operating Agent

Aalborg University

Per Heiselberg

Phone: + 45 9635 8541

E-mail: ph@bt.aau.dk

Technical University of Denmark

Bjarne W. Olesen

Phone: + 45 45 25 41 17

E-mail: bwo@mek.dtu.dk

France

ENTPE-LASH

Gérard Guarracino

Phone: + 33 4 74 04 70 27

E-mail: Gerard.guarracino@entpe.fr

INES - Savoie Technolac

Etienne Wurtz

Phone: +33 479 44 4554

E-mail: etienne.wurtz@univ-savoie.fr

LEPTAB - Université de La Rochelle

Laurent Mora

Phone: + 33 5 46457265

E-mail: laurent.mora@univ-lr.fr

CSTB

Faure Xavier

Phone: + 33 0476762574

E-mail: xavier.faure@cstb.fr

Italy, Leader of subtask A

DENER

Marco Perino

Phone: + 39 011 5644423

E-mail: marco.perino@polito.it

Università Politecnica delle Marche

Paolo Principi

Phone: +39 (71) 2204773

E-mail: p.principi@univpm.it

Japan

**National Institute for Land and Infrastructure
Management**

Takao Sawachi

Phone: + 81 298 64 4356

E-mail: sawachi-t92ta@nilim.go.jp

Tokyo Polytechnic University

Ryuichiro Yoshie

Phone: + 81 (0) 46-242-9556

E-mail: yoshie@arch.t-kougei.ac.jp

University of Tokyo

Shinsuke Kato

Phone: + 81 3 5452 6431

E-mail: kato@iis.u-tokyo.ac.jp

Building Research Institute

Yuji Hori

Phone: +81 (29) 864 6679

E-mail: horii@kenken.go.jp

Ritsumeikan University

Tomoyuki Chikamoto

Phone: + 81 77 561 3029

E-mail: tomoyuki@se.ritsumei.ac.jp

Kobe Design University

Yuichiro Kodama

Phone: +81 78 796 2571

E-mail: y-kodama@kobe-du.ac.jp

Nikken Sekkei Ltd

Tatsuya Hayashi or Takashi Yanai

Phone: + 81-3-5226-3030

E-mail: hayashit@nikken.co.jp

Misawa Homes Institute of Research and Development Co., Ltd.

Isamu Ohta

Phone:

E-mail: Isamu_Ohta@home.misawa.co.jp

Tateyama Aluminum Industry Co.,Ltd.

Yasuo Takahashi

Phone:

E-mail: y_takahashi@sthdg.co.jp

FUJITA Corporation

Akinori Hosoi

Phone: +8146 250 7095

E-mail: ahosoi@fujita.co.jp

Norway, Leader of subtask B**SINTEF Civil & Environmental Engineering**

Inger Andresen

Phone: + 47 92207049

E-mail: inger.andresen@sintef.no

**Norwegian University of Science and Technology
(NTNU)**

Øyvind Aschehoug

Phone: + 47 73 59 50 46

E-mail: oyvind.aschehoug@ark.ntnu.no

Poland**Cracow University of Technology**

Marian Hopkowicz

Phone: +48 (12) 628 28 96

E-mail: hopkowic@usk.pk.edu.pl

Portugal**LNEC, National Laboratory for Civil Engineering**

Fernando Marques da Silva

Phone: + 351 218 443 862

E-mail: fms@lnece.pt

Sweden

SP Swedish National Testing and Research Institute
Åsa Wahlström
Phone: + 46 33 16 55 89
E-mail: asa.wahlstrom@sp.se

University of Gävle

Mats Sandberg
Phone: + 46 26 64 81 39
E-mail: Mats.Sandberg@HiG.se

The Netherlands, Leader of subtask C

Cauberg-Huygen Consulting Engineers
Ad van der Aa
Phone: + 31 10 4257444
E-mail: a.vanderaa@chri.nl

Technical University Delft

Hans Cauberg
Phone: + 31 152283174
E-mail: J.J.M.Cauberg@citg.tudelft.nl

United Kingdom

The University of Aberdeen
Mohammed Salah-Eldin Imbabi
Phone: + 44 (0) 1224 272506
E-mail: m.s.imbabi@abdn.ac.uk

Brunel University

Maria Kolokotroni
Phone: + 44 1895 266688
E-mail: maria.kolokotroni@brunel.ac.uk

Buro Happold

David Warwick
Phone: + 44 113 204 2200
E-mail: David.warwick@burohappold.com

USA

Purdue University
Qingyan Chen
Phone: +1 765 494 2138
E-mail: yanchen@purdue.edu

Chapter 1 Introduction

1.1. Scope and focus

This report is complementary to the short summary of the state-of-the-art report presented in volume I and gives a more comprehensive source of information about the state-of-the-art reports for Responsive Building Elements (RBE).

Information have been contributed by all the participants in the project, and edited by subtask leaders in the group.

The RBEs covered are mainly associated with the building envelope and other major construction elements: foundations, exterior walls, interior walls, floors, roof, windows etc. The RBEs are designed to work in close interaction with the building mechanical and electrical systems, such as heating, cooling, ventilation, lighting, electricity supply, and control systems, in order to reduce the demand for energy. This indicates that the principles for application of RBEs are best suited for commercial buildings that display a full range of mechanical and electrical systems. But as residential buildings now also are employing more such systems, some of the information gathered here may also be useful for such residential construction.

The responsive building element working principles identified and described in this report are:

- Advanced integrated facades, for example double facades integrating ventilation
- Thermal mass of building elements used for storage of heat and coolth
- Earth coupling of foundation elements and buried ducts and culverts
- Dynamic insulation systems in walls, for example breathing walls preheating air
- Phase change materials integrated in building elements to enhance the ability to store heat and coolth

The report also covers different applications of the RBEs, gives available data for design and performance, and discusses barriers to application and needs for more research.

The participants in IEA ECBCS Annex 44 have registered 23 buildings that have integrated different RBEs in their energy systems. For some of these buildings performance data have also been included .

1.2. Definitions

Responsive Building Elements are defined as building construction elements which are actively used for transfer and storage of heat, light, water and air. This means that construction elements (like floors, walls, roofs, foundation etc.) are logically and rationally combined and integrated with building service functions such as heating, cooling, ventilation and lighting. The development, application and implementation of responsive building

elements are considered to be a necessary step towards further energy efficiency improvements in the built environment.

1.3. Responsive Building Elements - Preface

Research and technological innovation, over the last decade, have determined a significant improvement of performances of specific building elements like the building envelope - including walls, roofs and fenestration components - and building equipments - such as heating, ventilation, cooling equipment and lighting.

Whilst most building elements still offer some opportunities for efficiency improvements, the greatest future potential seems to lie with technologies that promote the integration of “dynamic” building elements with building services.

In this perspective the term “dynamic” translates into the fact that functions, features and thermophysical behaviour of such building components may change over the time and adapt to different building/occupants requirements (heating/cooling, higher/lower ventilation, ...) and to different boundary conditions (meteorological, internal heat/pollution loads, ...). Within Annex 44 such components have been defined as ***Responsive Building Elements (RBE)***.

The application of this concept in the building design and construction, means that building components are now actively used for transfer and storage of heat, light, water and air and that construction elements (like floors, walls, roofs, foundation etc.) are logically and rationally combined and integrated with building service functions such as heating, cooling, ventilation and lighting.

The development, application and implementation of responsive building elements are considered to be a necessary step towards further energy efficiency improvements in the built environment.

Examples of RBE include, among the others: façades systems (ventilated facades, double skin facades, adaptable facades, dynamic insulation,...), foundations (earth coupling systems, embedded ducts, ...), energy storages (active use of thermal mass, material - concrete, massive wood - core activation for cooling and heating, phase change materials, ...), roof systems (green roof systems, ...), active/passive solar systems, daylighting technologies.

In Annex 44 attention has been focused only on five specific responsive building elements, whose perspective of improvement and widespread implementation in the building sector seems to be much more promising.

1.3.1. Advanced Integrated Façade (AIF)

An Advanced Integrated Façade (AIF) is a building envelope that exhibits adaptive characteristics that are in tune with both the physical/ climatic conditions of a particular location and the indoor environment requirements. An AIF provides the basic functions of shelter, security and privacy, while minimizing energy consumption.

Among the all possible solutions and configurations of AIF attention has been focused on two main categories:

- transparent ventilated façades

- intelligent windows.

1.3.1.1 Transparent ventilated façades

The working principle of a transparent ventilated façade is to use the air gap between the two glazed panes to reduce the thermal impact on the building environment.

Over 200 buildings worldwide were found to be utilizing the concept of transparent ventilated façades. The geographic distribution of the buildings that use transparent ventilated façades shows that a large fraction of buildings are located in Continental/Northern European countries (56.7%) and Japan (13.0%). In these countries the climate conditions are probably more suitable for the use of transparent ventilated façades with cold winters and mild summers. However, as seen in a number of actual cases, habit and fashion may have a primary role in the choice of the building designer for the adoption of such an element. The majority of buildings (more than 90%) included in the state of the art review are of the office type.

The energy savings achievable with a transparent ventilated façade may result from an increase in the use of daylighting on peripheral areas and from an improved thermal behaviour, than can lead to a reduction in air conditioning use. Comfort may also be improved, because the temperature of the inner glazing surfaces is closer to the indoor temperature.

1.3.1.2 Intelligent windows

These are dynamically adjustable windows developed for natural and hybrid ventilation purposes. They have the capability of being integrated into the HVAC systems. The basic configuration consists of a horizontally pivoted window that is hinged just above midheight. When opened, the weight of the window is balanced with a counterweight (a ballast) located at the top of the window. In this way the wind pressure may be used to automatically and dynamically control the degree of opening of the window itself. Different configurations and combinations of ballast/hinge, based on the same working principle, allow to exploit the element either as an exhaust or a supply.

1.3.2. Thermal Mass (TM)

Thermal mass (TM) is defined as the mass of the building that can be used to store thermal energy for heating/cooling purposes. TM can be effectively used to reduce the wide outdoor temperature fluctuations and offers the engineers and architects a powerful opportunity to manage energy flows in the building efficiently.

Components typically adopted when the TM concept is applied include: the building envelope, the interior partition, the furnishing, or even the building structure.

According to its location, there are two basic types of thermal mass :

- external thermal mass
- internal thermal mass.

The external thermal mass, such as walls and roofs, is directly exposed to ambient temperature variation. The internal thermal mass, such as furniture and purpose-built internal concrete partitions, is exposed to indoor air temperature.

Furthermore, another classification may be done based on the type of activation:

- direct interaction system – when the thermal mass is directly exposed to the indoor air
- indirect interaction system – where the ambient air passes through floor voids, cores and air paths (such as for example TABS components: walls, ceilings, floors equipped with ducts for circulation of air or embedded pipes for circulation of water).

The thermal mass concepts are applied on both residential and commercial (office) buildings.

In general the application has been found to be particularly suitable for climates with big diurnal temperature variations. The most of the component applications can be observed in moderate climatic zones. Installations in cold climatic zones are limited mainly by the heating capacity of the system. Using the systems in hot and humid climate may give rise to condensation problems.

1.3.3. Earth Coupling (EC)

The basic principle of the Earth Coupling is to ventilate air to the indoor environment through one or several buried ducts, in order to exploit the seasonal thermal storage ability of the soil. This enables a cooling effect of the hot summer air and a heating effect of the cold winter air.

The ground's large thermal capacity is, therefore, used to preheat or pre-cool the ventilation air, resulting in energy savings for the building. Frequently, this technology is also addressed as "Earth To Air underground Heat Exchangers".

In buildings with required indoor air temperatures between 20°C to 26°C, Earth Coupling is primarily used for cooling purposes, since soil temperatures are usually below the indoor air temperature most of the time. However, Earth Coupling can also be used for winter heating, when the outdoor air temperature is much lower than that of the soil, but additional heating systems are usually needed in this case.

Most existing EC systems are installed in mechanically ventilated buildings. However, recently, to reduce the fan energy consumption, some hybrid and naturally ventilated buildings have also been designed and built.

EC's application seems not to be restricted to a particular building type. Examples of application comprise greenhouses and livestock houses, as well as residential and commercial buildings. The working principle makes it suitable for a wide range of different climate conditions, provided that a sufficiently large temperature difference between summer and winter and between day and night are available.

1.3.4. Dynamic Insulation Walls (DIW)

The concept of Dynamic Insulation Walls (DIW) combines the conventional insulation with the heat exchange characteristics of an outer wall.

The system allows an effectively pre-heating of the ventilation air. DIW are regarded as one possible method for reducing building envelope heat losses while achieving better indoor air quality.

One of the most promising existing technology within the DIW category is represented by the so called “Breathing Wall” (BW). A BW is a suitably designed wall which let an air transfer through a permeable insulation layer. The system can act as a contra-flux mode heat exchanger and it usually consists of two main sub-layers: an external envelope - through which the ventilation air can be introduced from the bottom or top - and a dynamic insulation sub-layer.

The air flow through the wall is, usually, assured by means of mechanical ventilation, but “natural” systems have also shown encouraging performances.

Dynamic insulation has the potential to be implemented in most climate conditions, however, even though the concept has been developed more than 30 years ago, dynamic insulation has not yet really been implemented in building design, because of its specific problems and uncertainties.

1.3.5. Phase Change Material (PCM)

PCM are suitable materials that, at the atmospheric pressure, undergo a phase change around the ambient temperature.

The basic principle is to exploit their capability of storing large amount of heat at temperatures close to their melting point. In fact, as long as the phase change is under way, heat is stored and released without any sensible temperature variation of the medium. This property can be used as a means of increasing the thermal inertia (thermal mass) of the building components and, therefore, to smooth and shift the cooling/heating loads.

The energy storage capacity of PCM per unit mass is much greater than that of usual building materials, like concrete or brickwork. For this reason, PCM are often used in case of lightweight constructions.

Different applications are possible:

- integration of PCM in external wall structures,
- thin layered latent heat fibre boards or granular PCM placed in internal partitions
- PCM plaster to be applied on ceiling/walls indoor surface,
- under floor applications,
- Air (or water) heat exchanger with PCM energy storages (combined with traditional Air Handling Unit).

Thanks to the smoothening and the time shift of the heat loads, smaller HVAC appliances can be installed in building making use of PCM components and, as a results, lower investment and operational costs may be achieved.

As far as the climatic conditions are concerned the two main issues that could limit the effective use of this technology are: the night outdoor air temperature (it has to be sufficiently lower then the daytime value) and the heat transfer coefficients between the air and the element encapsulating the PCM.

Chapter 2 Advanced Integrated Façade (AIF)

2.1. Introduction

Within Annex 44 Responsive Building Elements (RBE) are defined as construction elements that assist in maintaining an appropriate balance between optimum interior conditions and environmental performance by reacting in a controlled and holistic manner to changes in external conditions and to occupant interaction [IEA-ECBCS Annex 44 (2004)].

Advanced Integrated Façades (AIF) are one type of RBE and can be considered as the actual development of what started with passive architecture concepts and evolved into the intelligent skins (or façades) concept. The basis of all of those concepts is the same: contribute to indoor environment improvement, thus reducing operating costs and minimizing lighting and heating/cooling use. A brief review of this evolution may help to frame the AIF concept.

Passive architecture allows for adjustment to climate changes by using the simplest and oldest way of control, which has been in use for centuries: manual operation of shutters and Venetian blinds or the opening of windows. This type of control, however, may not address comfort problems, especially when dealing with large buildings. This leads to the need for other types of control over the building envelope.

New comfort concepts improve upon the “simple” thermal approach by using a wider approach to comfort that is concerned with the overall well-being of occupants. Such concepts lead to more transparent buildings, mainly in the services area. Transparency is indicative of a strong visual connection between the building interior and the surroundings, as if the building itself could be part of it. This allows for the otherwise separated indoor and outdoor environments to “merge”. The view to the outdoors is not limited which results in an atmosphere that is better appreciated by occupants. From the outside point of view a transparent envelope has a pleasant appearance, evokes high-tech images and transforms the façade in a landmark in the urban landscape.

The first realizations of this concept used single glazed façades. However, various drawbacks concerning indoor thermal comfort soon surfaced. During cold winter months, the condensation of water vapour compromised the high-tech image of the buildings and cold drafts created concerns among the people located near the glazed walls. During hot summer months, overheating of the glazed surface due to direct solar radiation severely compromised indoor comfort. Also the building owners discovered the implications of such highly glazed buildings: energy consumption for assuring proper indoor environmental parameters was very high [Perino, M (2005)].

Innovative glazing systems with solar shading devices improved performance. Testing of these systems showed that problems related to the cold season could be solved with no great difficulty and at a reasonable cost. On the other hand, problems related to the hot season proved to be much more difficult to solve and more costly to implement.

A straightforward technique traditionally used by southern European countries consists of moving adjustable shading devices to the exterior side of the glazing. This allows for control of the incoming radiation both in the summer (preventing it) and in the winter (permitting it). Since the shading systems are outdoors, they should be rough and reliable, providing

protection from adverse weather conditions. As a result the complexity and maintenance costs of the systems increase.

The term double skin façade (DSF) refers to an arrangement with a glazed skin on the exterior of the main glazed façade, forming a cavity between the outermost layers. Solar control devices are placed within the cavity, where they are protected from weather and air pollution. It did not take long to evidence the advantages that resulted from allowing air to flow in the cavity. For this reason DSF are often designated as ventilated façades. Further advantages arise from the extra skin that introduces control over the wind pressure on the inner façade for. For some of the DSF configurations, natural ventilation is even possible in high-rise buildings. Airflow is driven by both wind and the stack effect generated within the cavity. This stack effect is due to the solar collector behaviour of the cavity, which is further enhanced by reradiation from the shading devices. Much of the heat that is removed by the ascending air flow may be recovered and used to preheat air for conditioning the interior spaces.

DSF also act as a thermal buffer between the outdoor and indoor spaces by keeping the innermost glazed surface at a temperature that is closer to the indoor temperature even in the hot summer and cold winter months. As a result of the increased thermal comfort conditions, areas closer to the windows can be better utilized.

A further advancement was achieved when the idea of “intelligence” was included on DSF, introducing the intelligent skin/façade/glass-façade concept.

An intelligent façade (IF) is defined as “a composition of construction elements confined to the outer, weather-protecting zone of a building, which performs functions that can be individually or cumulatively adjusted to respond predictably to environment variations, to maintain comfort with the least use of energy” [Wigginton, M and J Harris (2002)].

The concept of “intelligence” associated with DSF represents a change from a static envelope to one with a dynamic behaviour. The façade is then capable of adapting to changes in outdoor conditions in order to achieve indoor comfort requirements and reduce energy consumption.

An IF should make use of natural renewable sources (solar energy, airflows or ground heat) in order to maintain the building requirements in terms of heating, cooling, ventilation and lighting. It should also result from an “intelligent design” rather than just an assembly of “intelligent components”. This implies that the design process should be integrated in order to achieve interior comfort through efficient, energy-saving measures.

A number of technologies that are used to achieve energy-saving goals include natural ventilation, night-time cooling, natural lighting, buffer zones or solar assisted air-conditioning. Such technologies require an effective interaction between the façade and the building. Therefore, the designer needs to have a good understanding of the performance that might be achieved. This information, which is application specific, may be obtained through simulations and tests.

The collective term Advanced Integrated Façades (AIF) gathers all of the aforementioned concepts and establishes a strong connection between building energy and control systems.

From architectural and technical points of view, an AIF can be summarized as an RBE that is in tune with both the physical and climatic conditions of a particular location. It is a building envelope that exhibits adaptive characteristics. The dynamic behaviour of an AIF provides the basic functions of shelter, security and privacy, while minimizing energy consumption. Being closely connected to the building energy and control systems, an AIF has to contribute to environmental sustainability and make the building a structure with climatic sensitivity.

2.2. Classification criteria

AIF classification is not a straightforward task due to the number of different and cumulative aspects to be considered. However DSF classification criteria can be used as a basis.

Most common classifications consider the type of ventilation, the flow path and the system configuration as major items. Nevertheless, a number of other criteria have been proposed [Clements-Croome, D (1997)] and summarized in several ways including a tricky to use matrix, alpha-numeric systems, tree shaped systems connecting primary and secondary identifiers, and classifications based on commercial brands or specific technical aspects.

Within Annex 44 an updated classification of the most common criteria will be followed and established definitions will be used, with some added definitions that correspond to the work carried out by the present task.

2.2.1. Type of ventilation

The driving force of the air flow within the cavity defines the type of ventilation. Types to be considered are:

- Natural Ventilation (NV), with the driving force being the wind induced pressure distribution or the stack effect.
- Mechanical Ventilation (MV), with the driving force being supplied by a fan.
- Hybrid Ventilation (HV), which using both of the previous as a function of ventilation needs and outdoor conditions.

2.2.2. Flow path

The air flow path is a very important issue that is strongly associated with how the AIF is integrated into the building energy and control systems. Possible arrangements are:

- Exhaust Air (EA): the AIF acts to remove indoor air (Fig. 2.1a).
- Supply Air (SA): the AIF acts to supply air to the indoor environment (Fig. 2.1b).
- Reversible Air Flow (RAF): the AIF acts as both of the previous depending on indoor/outdoor conditions and local control devices (Fig. 2.1c).
- Outdoor Air Curtain (OAC): the AIF cavity is ventilated by outdoor air with no connection to the indoor air (Fig. 2.1d).
- Indoor Air Curtain (IAC): the AIF cavity is ventilated by indoor air with no connection to outdoor air (Fig. 2.1e).

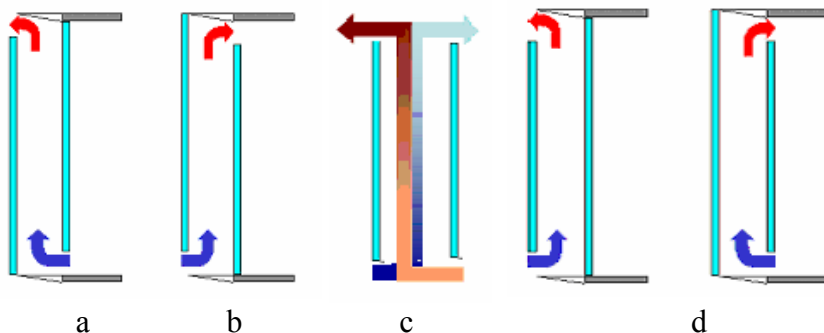

Figure 2.1. AIF flow path: EA-a); SA-b); RAF-c); OAC-d); IAC-e) [Haase, M (2005c), Gosselin, JR (2005)]

2.2.3. Façade configuration

Façade configuration is based on the Belgium Building Research Institute's (BBRI) classification for DSF, the most well-known and widely adopted in Europe. Modifications were made to this classification by merging some of the main characteristics with other classification systems, including the classification method used in the USA [Perino, M (2005)]. This proposed classification, represented schematically in Fig. 2.2, simplifies the original.

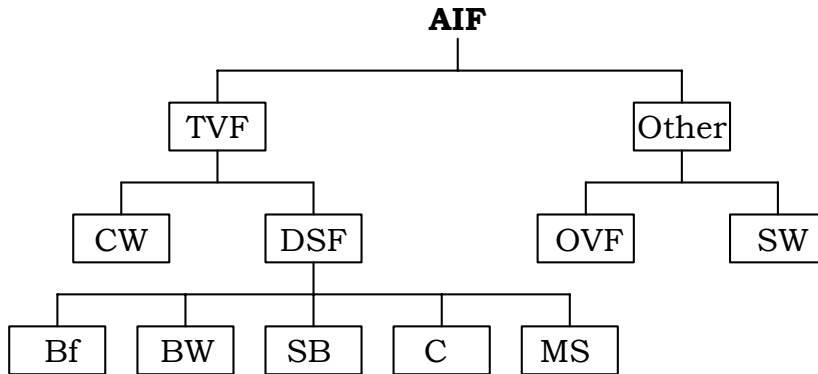

Figure 2.2. Proposed simplified classification of AIF, based on configuration (TVF = Transparent Ventilated Façade)

A brief review of the AIF configuration definitions is presented below.

- Climate wall (CW): merges the climate façade/climate window concepts, the difference between them being the existence or lack of a window breast. A CW is characterized by an external double glazed pane, an internal single glazed pane or curtain, a MV connection to the building ventilation system, and a small gap (~10 mm) under the interior pane that allows air to flow into the cavity. This arrangement is similar to a box-window and is shown in Fig. 2.3 [BBRI, (2002)].

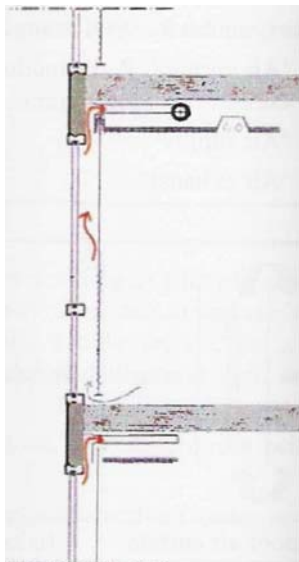

Figure 2.3. DSF - climate wall configuration

- Buffer (Bf): The still air within the cavity acts as a thermal buffer even if the cavity is connected to the outdoor air for pressure balance purposes. Fig. 2.4 shows a typical Bf [Haase, M (2005c)].



Figure 2.4. DSF - buffer configuration

- Box Window (BW): The DSF is divided both vertically and horizontally, forming a box. Trombe walls can be included in the BW classification. Fig. 2.5 shows a typical BW [Haase, M (2005c), Oesterle, et al (2001)].

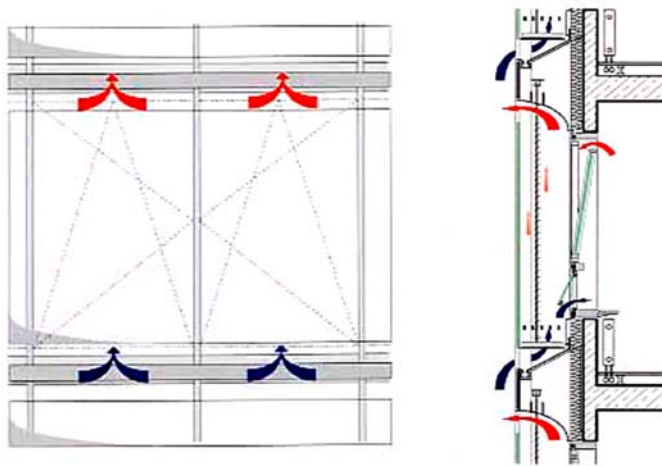

Figure 2.5. DSF – box window configuration

- Shaft box (SB): The SB has a similar configuration to the BW but the box discharges exhaust air to a lateral building-height cavity, as shown in Fig 2.6 [Haase, M (2005c), Oesterle, et al (2001)], Compagno, A (2002)].

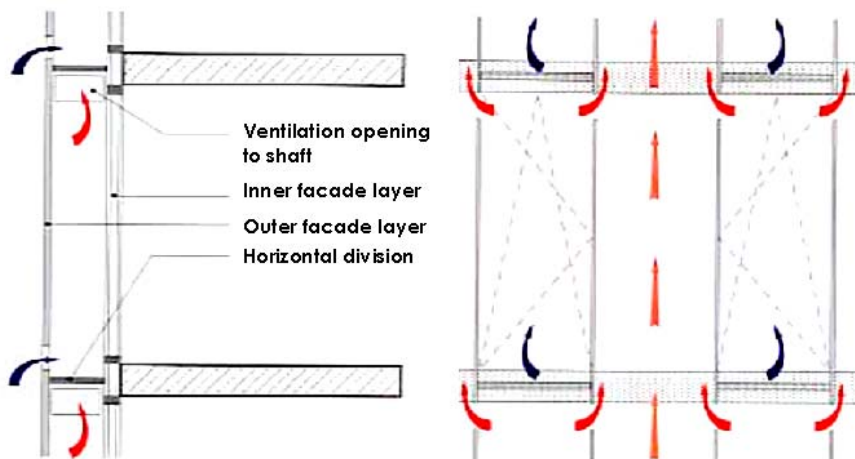

Figure 2.6. DSF – shaft box configuration

- Corridor (C): This type of DSF is horizontally divided, forming a storey level corridor. Inlet and outlet openings are placed in such a way that the mixing of exhaust air and supply air to the above storey is avoided. The C configuration is shown Fig. 2.7 [Haase, M (2005c), Oesterle, et al (2001)].

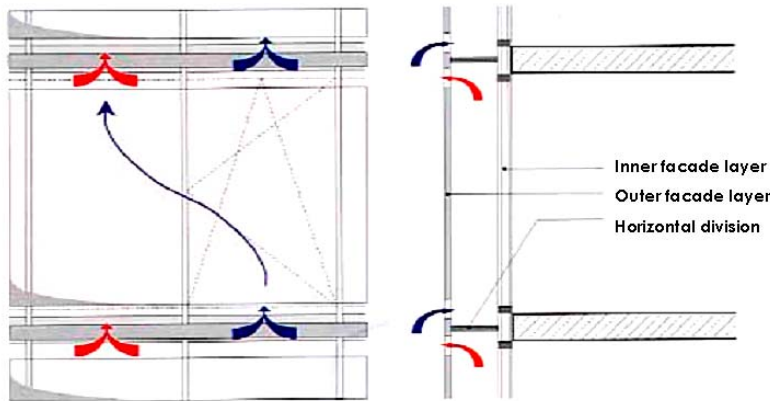

Figure 2.7. DSF – corridor configuration

- Multi-storey (MS): A MS system is a DSF with no cavity partitions. Louvered façades are a particular case of MS, in which the external skin is composed of louvers that move from a closed to an open position. In the open position, they no longer act as a second skin. A typical MS is shown in Fig. 2.8a [Haase, M (2005c), Oesterle, et al (2001)]. The USA designation for Twin Façades fits within this group, Fig. 2.8b [Perino, M (2005)]

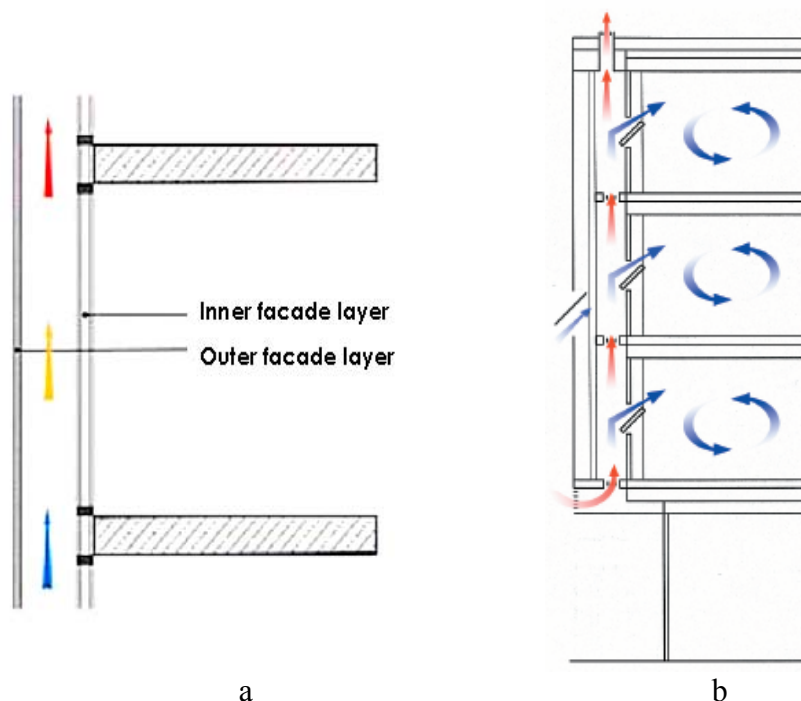

Figure 2.8. DSF – Multi-storey (a) and Twin Façade (b) configurations

- Swindow (SW): This is an opening developed for natural ventilation purposes with the capability of being integrated into the HVAC systems. The basic configuration consists of a horizontally pivoted window that is hinged just above midheight. When opened, the weight of the window is balanced with a counterweight located at the top of the window, as shown in Fig 2.9. Different constructions with the same working principle are used for exhaust and supply modes, depicted in Fig. 2.10, [Takahashi, Y (2005)].

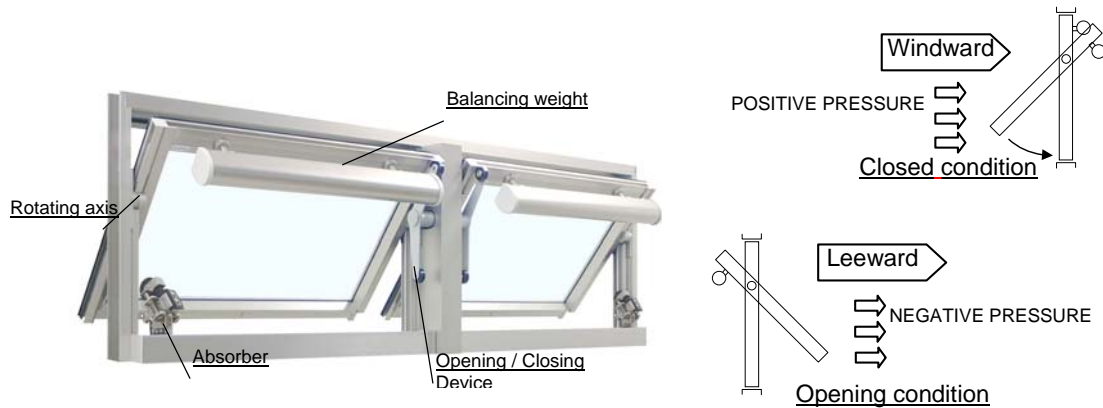

Figure 2.9. Exhaust Swindow and working principle



Figure 2.10a. Exhaust Swindow



Figure 2.10b. Air Supply Swindow (View and detailed crossection)

- Opaque ventilated facade (OVF): This kind of AIF is based on the working principles used in a Trombe wall.

2.3. Examples of applications

Within this state of the art review, a search was carried out in order to highlight how, where and how often different kinds of DSF/AIF are used in existing buildings.

The search has been carried out by referencing thematic books, architectural magazines, journal publications and the Internet.

Over 200 buildings worldwide were found to be utilizing the DSF/AIF concept. It should be noted that it is not possible to assume that this search is exhaustive or to be certain that this figure is close to a final count, as can be inferred from the figures from Canada, Sweden, and the USA, for example.

2.3.1. Geographic distribution

The geographical distribution of the buildings that use DSF/AIF shows a dominant fraction are located in Continental/Northern European countries (56.7%) – Germany, Switzerland, Finland, France and Belgium. Japan also contributes a large percentage of about 13.0%. In those countries the climate conditions are probably more suitable for the correct adoption of these envelope technologies with cold winters and with not too hot summers. However, as seen in a number of actual cases, habit and fashion may have a primary role in the choice of the building designer for the adoption of a DSF/AIF.

Germany represents 22.8% of such buildings, followed by Japan (13.0%). The wide presence of DSF/AIF in Germany may be linked also to the fact that Germany has been one of the first countries to study and develop this kind of technology since it was already a consolidated tradition there.

On the other side a very small number of buildings were identified in Canada, USA, Austria, or Norway and no buildings were found in Sweden.

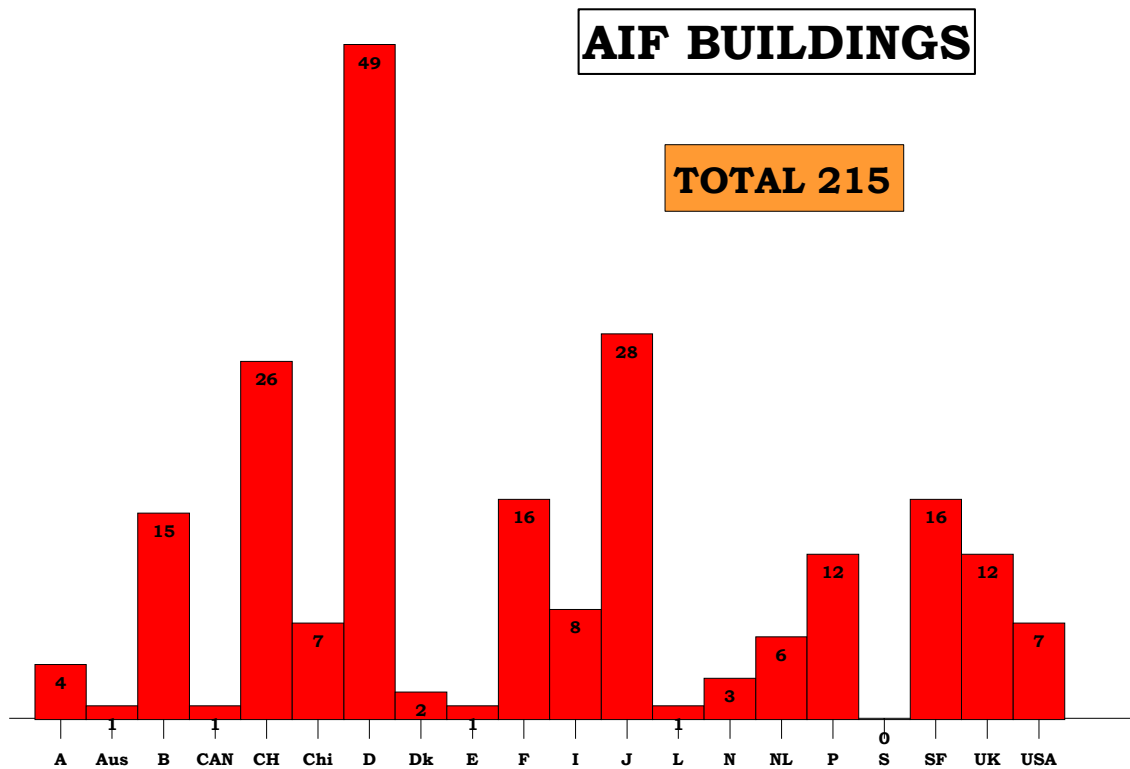

Figure 2.11. DSF/AIF geographical distribution out of 215 buildings total

2.3.2. Typologies

At this moment it was not possible to obtain information concerning configuration, flow path or type of ventilation for some of the identified buildings. In some cases there is no information at all, while for others information for at least one of the typologies is missing. Fig. 2.12 summarizes the DSF/AIF typologies.

According to the proposed criteria, the configuration with the greatest percentage (within transparent façades) is the DSF/Multi-storey (47.0%). At the other extreme is the Swindow, which is only used in Japan (2.3%). Box-window and Corridor configurations show similar figures. The least adopted solution is the Shaft box.

The type of ventilation is one of the main characteristics of a DSF/AIF. Natural ventilation is the most common solution (58.1%), while hybrid ventilation proved to be the least common solution.

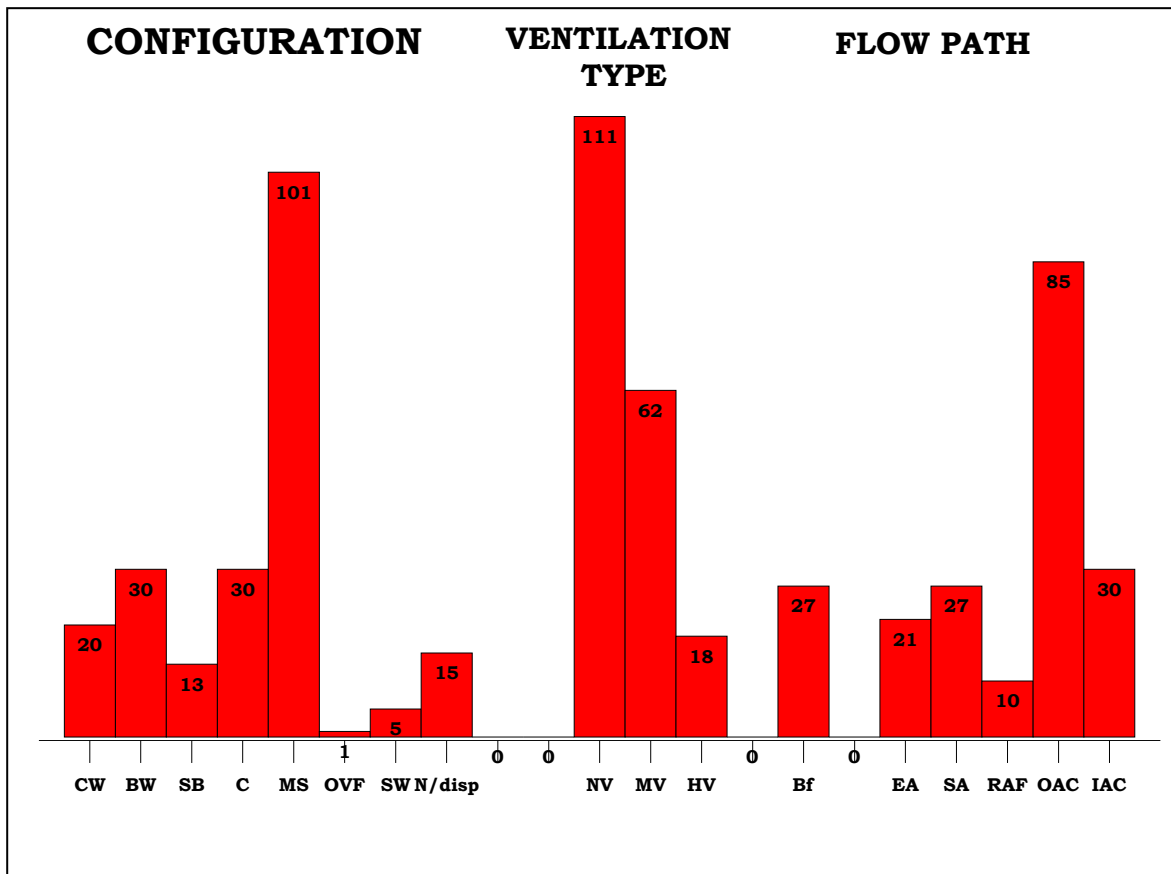

Figure 2.12. DSF/AIF typologies of identified buildings

Regarding the airflow path, the most common solution is the outdoor air curtain (49.1%). All other airflow path options, except the RAF type, fall within the same magnitude. It should be noted that a significant number of buildings present more than one possible solution concerning air flow path.

Information on year of construction/retrofit is available for 75% of the identified buildings, as summarized in Fig. 2.13. It was found that almost all of the buildings were newly constructed.

The first identified DSF building was built at the Cambridge University in the UK in 1967 [Compagno, A (2002)]. The majority of construction/retrofit occurred between 1995 and 2003 (80.1%) after some attempts in the 1980's.

It is not difficult to explain this behaviour, considering all the elements that could influence such a trend. For instance, the World and European economy supported a reduction in energy consumption. Other more comprehensive technical issues encouraged AIF use. In the past many designers supported the choice of a ventilated façade, claiming that this technology was sustainable, enhanced the indoor comfort conditions and reduced energy consumption. Frequently, however, these issues were not assessed, validated or quantified in a clear way. As a result, a number of DSF/AIF did not perform in the expected way, and the actual performances were far worse than the forecasted ones.

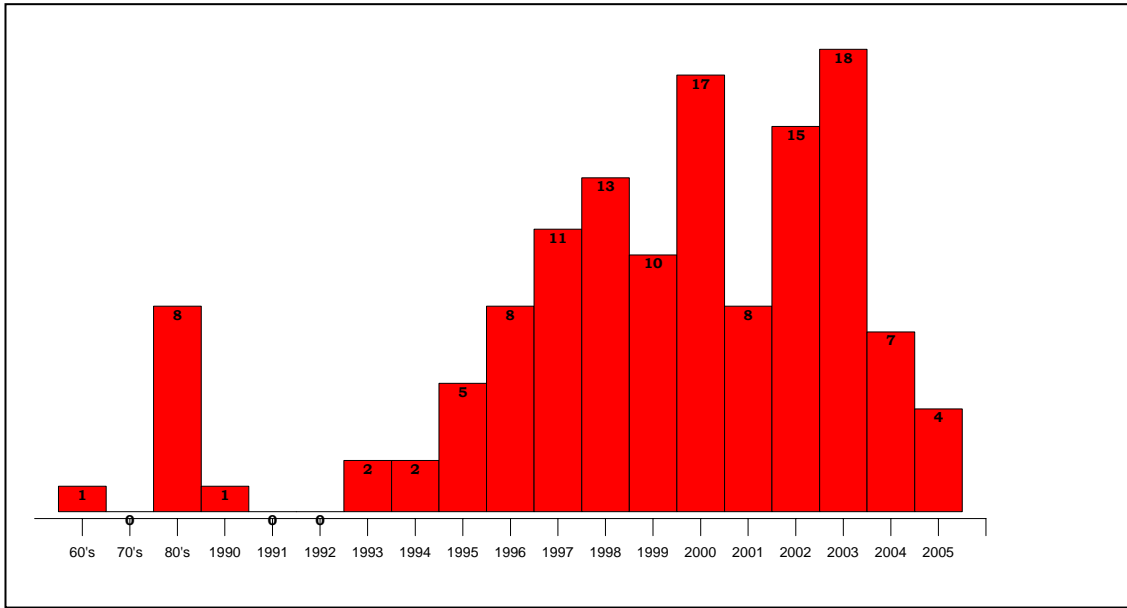

Figure 2.13. DSF/AIF – Year of construction/retrofit

This has thrown a bad light on the technology and may explain a certain resistance against its selection by designers, leading to the reduction in the existing applications after the year 2003.

It is also interesting to note that in the period of major diffusion of DSF/AIF, the most common typologies were the multi-storey configuration, naturally ventilated systems, and the outdoor air curtain mode, Fig. 2.14.

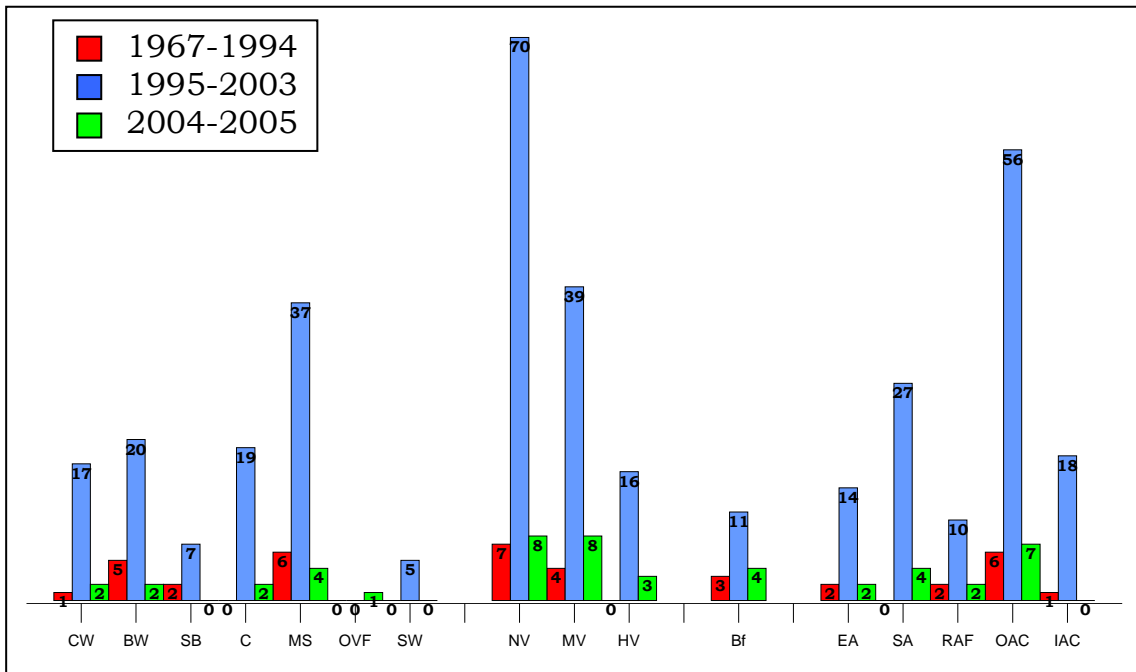

Figure 2.14. DSF/AIF – Typologies by period

2.4. Working principles

2.4.1. Transparent ventilated façades

The working principle of a transparent ventilated façade is to use the air gap between the two glazed panes to reduce the thermal impact on the building environment. The air gap may use natural, mechanical or hybrid ventilation schemes, or simply act as a still air buffer.

Solar radiation loads are absorbed to some extent, depending on the glazing properties of both the exterior and interior panes and the shading system. The ventilated air gap then removes the absorbed heat, thus cooling the solar shading device.

The air flowing within the air cavity has several beneficial uses. During winter months the air that leaves the air cavity has a temperature that is higher than the outdoor air. As a result, the air can be used either for preheating the ventilation air, or it can be used directly as ventilation air. Even during summer months, this rising air may be used to extract indoor air. In the case of an outdoor air curtain, the rising air keeps the window pane from overheating. For some window configurations, the presence of a second skin allows for control over the wind pressure acting on the façade. In this way a double skin façade may be suitable for the natural ventilation a high-rise building.

Figure 2.15 illustrates the window physics, showing the complexity and impact of solar radiation, conduction and convection on the airflow through the double-skin gap.

The way that DSF air flow and thermal conditions are connected to the indoor environment depends on the typologies described above. Indoor comfort can be improved by using various strategies: nighttime ventilation to remove accumulated heat from internal loads, with a possible enhancement when coupled to a thermal mass; various modes of operation to achieve hybrid ventilation; solar chimneys for natural ventilation induced by the stack-effect; stack-effect trough atria, or; supply of preheated cavity air directly to the indoor environment or to the conditioning unit.

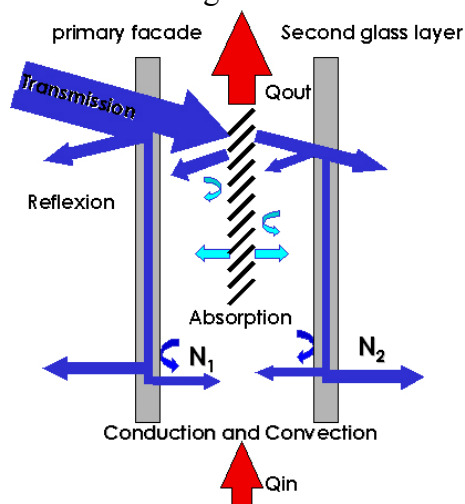

Figure 2.15. DSF/AIF – Working principle

Reversible air flow configurations allow the DSF to operate as an extract/supply air device, depending on needs and indoor/outdoor conditions. Also, depending on the implemented system it may act as an outdoor or indoor air curtain. New approaches to this concept are under development.

To summarize, the main functions that a DSF may provide are:

- to recover heat during cold season and/or preheat ventilation air,
- to improve the thermal insulation of the glazed system during both hot and cold seasons,
- to reduce solar loads and enhance natural lighting control without the drawback of the overheating of a solar shading device located in the indoor environment, and
- to extend the use natural ventilation, particularly in the case of high rise buildings.

When connected to the building energy system, all of these features contribute to the reduction of energy consumption and the improvement of thermal comfort. Although some of the aforementioned issues are in contradiction to each other, an optimal ventilated façade design can be achieved by employing a dynamic “adjustment” of the system so that it can adapt to the working conditions.

2.4.2. Swindow

As mentioned above there are two types of Swindows: air supply and exhaust (Fig. 2.10). The Swindow is in the open position at 45° from vertical when the wind is calm. It then starts to move when the wind blows. The Swindow operates even in weak winds and provides unidirectional air flow in the supply or exhaust direction, while limiting surplus air flow.

Conceptual diagrams of the ventilation characteristics of typical buildings with Swindows are shown in Fig. 2.16 and Fig. 2.17, respectively. Common openings in the façade (i.e. windows) may not provide efficient ventilation, as displayed in Fig. 2.16. Fresh air from the windward direction flows from the ambient zone to the occupied zone and then mixes with the inside air. On the other hand, Air Supply Swindows introduce fresh air into the occupied zone and then efficiently exhaust air through Exhaust Swindows located in the ambient zone without disturbing the inside temperature stratification (Fig. 2.17). When it is calm, efficient displacement ventilation is also provided (Fig. 2.17) [Takahashi, Y (2005)].

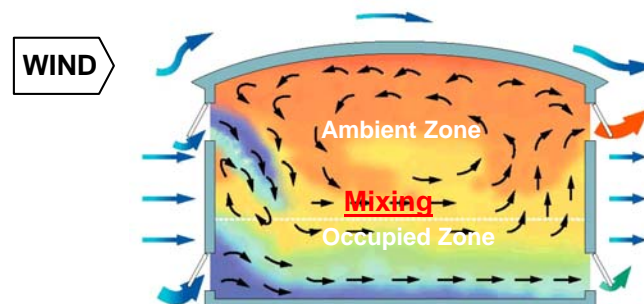

Figure 2.16. Natural ventilation using commonly used openings

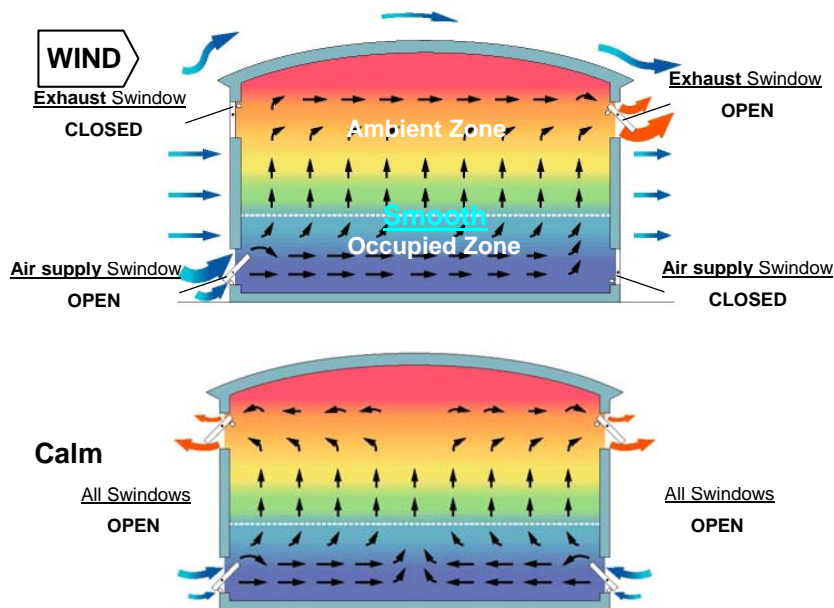

Figure 2.17. Natural ventilation using Swindows

2.4.3. Opaque ventilated facades

As previously mentioned OVF are essentially Trombe walls, a sun-facing wall built from material that provides thermal mass storage (such as stone, concrete, adobe or water tanks). When combined with an air space, insulated glazing and vents, the system forms a large solar collector. Modern Trombe walls add vents to the top and bottom of the air gap between the glazing and the thermal mass. Heated air flows via convection into the building interior. The vents have one-way flaps which prevent convection at night, thereby making heat flow strongly directional. This kind of design is an isolated passive thermal collector. By moving the heat away from the collection surface, it greatly reduces thermal losses at night and improves overall heat gain. Generally, the vents to the interior are closed during summer months when heat gain is undesirable.

2.5. Design criteria

An Advanced Integrated Façade considers the combined use of several technical solutions in order to fulfil the design goals described above.

A number of such technologies may be identified:

Solar control

- spectrally selective glazing
- simple and selective shading
- solar filters
- active and passive solar systems

Lighting

- sunlight and sky light redirection

Ventilated façades

- climate walls

- double-skin façades
- ventilated Trombe walls
- Swindow walls

This part of the state of the art report refers only to ventilated façades or, more specifically, to the ventilation and outdoor thermal load control aspects of an AIF.

2.5.1. Sound insulation

Undoubtedly an effective outcome of DSF is sound insulation. Acting as a protection wall, the external glazed pane reflects exterior sound, which significantly reduces interior noise levels, even if the interior windows are open. Operable windows are possible with DSF when external noise levels are around 68-75 dB(A), conditions applicable to a wide range of inner city properties [Oesterle, et al (2001)]. However, noise produced indoors may be reflected back to the interior by the external pane (when interior windows are open), leading to the possible transmission of sound and information from room to room and floor to floor [Oesterle, et al (2001)].

2.5.2. Energy

When a designer wants to achieve energy savings, the use of DSF is one possible solution. However, figures from real buildings show very different values for yearly overall consumption. For instance, Lee (2002) reported the energy consumption for three German buildings with AIF/DSF. Values ranged from the excessive 433 kWh/m²-yr to 59.8 kWh/m²-yr when coupled with other innovative techniques.

Energy savings may result from an increase in the use of daylighting on peripheral areas. Depending on the control scheme used, energy reductions between 38-52 W/m² may be achieved. Improved thermal behaviour can lead to a reduction in air conditioning use, while still achieving thermal comfort conditions. Comfort may also be improved, because the temperature of the inner glazing surfaces is closer to the indoor temperature.

As stated by Pasquay (2004), while DSF can save energy as compared with conventional solutions with full air conditioning, they may not be the best choice for every location.

2.5.3. Wind action

The wind-building interaction determines the building envelope pressure distribution, which has a significant effect on ventilation flows. In particular, it affects the natural ventilation strategies selected.

Wind pressure is defined as the average of stationary and fluctuating turbulent components. The first component, often called the “static pressure”, is connected with large scale air movements that change slowly in time. The second component is related to short-term changes in air speed and direction due to atmospheric turbulence.

Turbulent fluctuations are “dumped” by the DSF due to the combined effect of openings in the inner and outer panes in conjunction with the cavity, which acts as a buffer (Fig. 2.18). This is of particular importance in high-rise buildings where gust loads may induce high peak pressure values [Oesterle, et al (2001)].

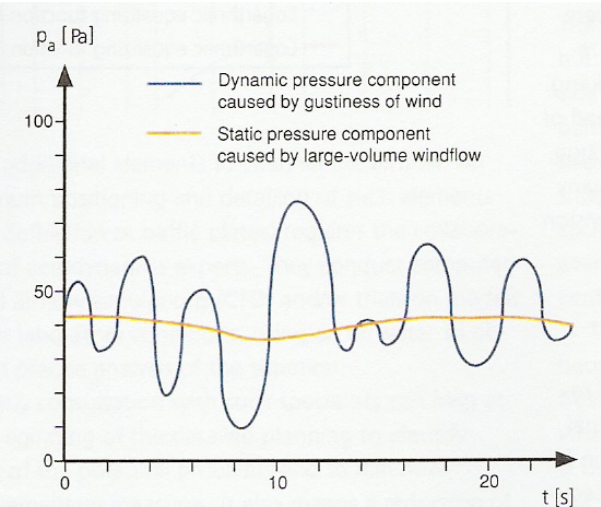

Figure 2.18. DSF/AIF – Dumping effect on turbulence [Oesterle, et al (2001)]

The stationary pressure distribution of the building envelope is usually expressed in terms of the nondimensional pressure coefficient, C_p , which relates the difference between local envelope and static atmospheric pressures to the dynamic wind pressure. Envelope C_p distributions are common and an example may be found in [Oesterle, et al (2001)] or in structural safety codes.

A major factor that influences pressure distribution is the building shape. DSF configuration can dramatically change cavity pressures when compared to an “unsheltered” envelope. Figures 2.19 and 2.20 represents the C_p distributions obtained on wind tunnel tests over a 10 storey, scaled model of a building under an urban boundary layer wind velocity profile.

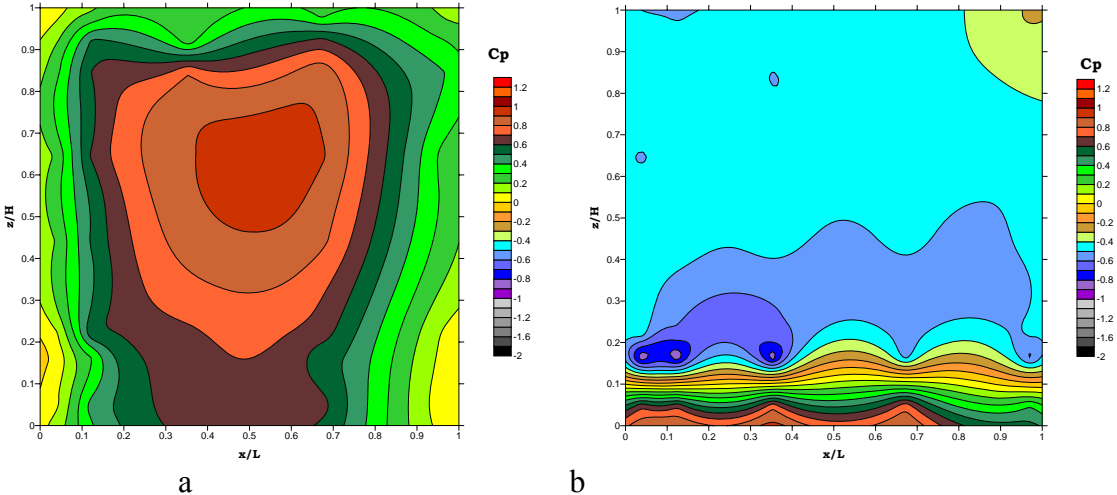

Figure 2.19. C_p distribution over an “unsheltered” envelope a), and a MS-DSF b), for a 0° (perpendicular) wind incidence

The DSF has a multi-storey configuration, open at the bottom and top and closed in the lateral direction. The bottom edge of the DSF is 3 m above ground level, and the cavity has a depth of 0.8 m [Marques da Silva, F and MG Gomes (2005)].

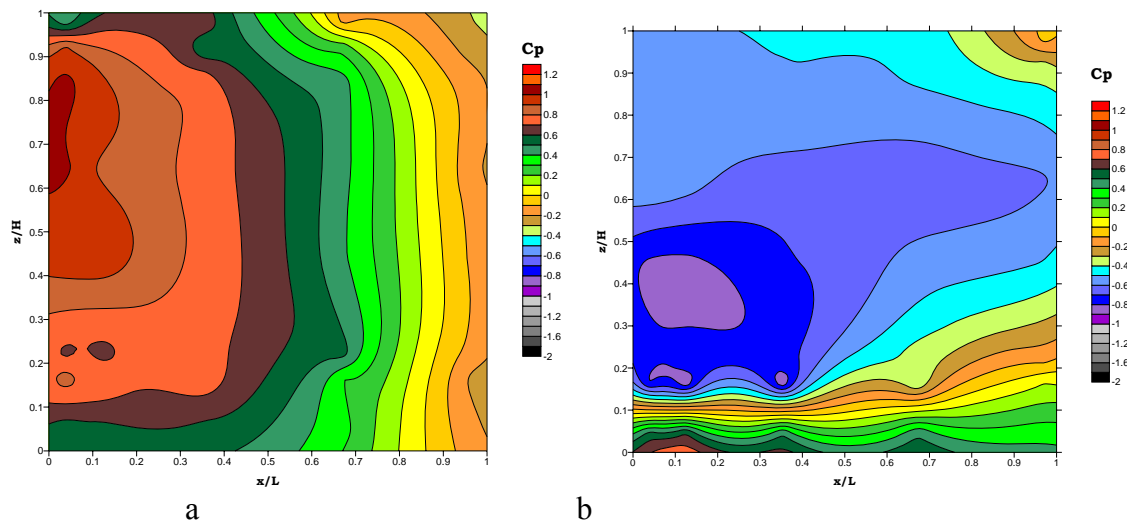

Figure 2.20. C_p distribution over an “unsheltered” envelope a), and a MS-DSF b), for a 45° (corner) wind incidence

This change in pressure values should be accounted for in order to properly evaluate wind loads on the external pane and the type of ventilation strategy to be used. Potential difficulties in manoeuvring doors or windows to the cavity may also be affected by such pressure values.

2.6. Application field

Although the state of the art review did not yield a complete overview of the application field in which DSF/AIF have been used, it was possible to determine that less than 20 buildings (~10%) are not of the office type. Among them it was possible to identify airports (2), malls (3), schools (5), Courts of Justice (2), libraries (2), and a hotel, hospital and demonstration and science building with one example each.

2.7. Available design tools

The ability to accurately estimate the energy performance of a DSF/AIF during the design process is essential. This may be achieved through the use of simulation tools that are able to model the façade, compare different solutions and properly evaluate its behaviour in order to make educated design decisions.

Modelling with simulation tools is not an easy task due to the several interactions of the physical processes inherent to each kind of Responsive Building Element (RBE). For example, variations in the geometry, configuration, and optical properties of the glazing have an effect on the thermo-physical and aerodynamic performance of the RBE system.

Two types of categories for simulation tools can be identified:

- component – for thermal, energetic and lighting behaviour, and

- building – for thermal behaviour of the whole building, including the façades [BBRI (2002)].

Both types are important and depend on the specific field of application for the RBEs. Note that although the building simulation tools can model façades, they are not tailored to model DSF/AIF configurations.

The ideal simulation tool would accurately model the outdoor climate (temperature, humidity, wind and radiation), the DSF/AIF (glazed panes, shading devices, ventilation strategy, thermal properties), the building (physics, occupancy schedule, air conditioning system), the control system and the interaction of all these variables simultaneously. Such a tool does not yet exist in a form that is ready for designers to use.

Each part of such a tool has particularly difficult tasks to perform, as is briefly described below:

Outdoor climate

- Both wind speed and direction are important for ventilation purposes and should be accurately predicted, especially for the case of naturally ventilated façades. Due to the continuous variability of the wind in space and time, it is very difficult to assess its characteristics around the façade. Properly time averaged variations and special correlations over the façade should be considered for detailed simulations.
- Ground reflected radiation should be known in order to completely determine incident solar radiation and its transmittance through shading devices near the ground.

Façades

- The shading device is particularly difficult to model due to the complex interaction between the shading device and solar radiation and airflow. This has a direct influence on the device heat balance (natural or forced convection).
- In naturally ventilated façades, the combination of the stack and wind effects has to be considered, because they can act cumulatively or in opposition and directly influence airflow rate.
- In order to operate an AIF, a dynamic control system is needed. Implementation of such a control system is difficult since an accurate model for simulation purposes is not readily available. Nonlinearity of the system physics (occupant behaviour) and simulation outcome (energy, thermal or visual comfort) are among the major problems to be solved.
- Materials that transmit or reflect light via a nonlinear manner (light-redirecting daylight, prisms, metallic shades, angular selective coatings) [Lee, et al (2002)].

Research groups have developed a number of models that are able to simulate DSF/AIF with different levels of sophistication. These models were usually developed using commercial CFD based software such as:

- FLUENT (<http://www.fluent.com>)
- Star-CD
- CFX
- FloVent (<http://www.flomerics.com>)

The software packages FLUENT and FloVent have been used to simulate ventilated facades [Kautsch, et al (2002); Manz (2003)].

Analytical and numerical models have been used to study the performance and optimization of DSF. Various authors have used the analytical approach to understand the physical working principles of DSF, to propose more efficient designs and to validate numerical

models with varying levels of complexity. The numerical models have several levels of complexity, ranging from simple to more complex ones such as CFD. The simple methods include the lumped, non-dimensional, network and control volume approaches [Jiru and Haghighat (2005)].

A more simple modelling procedure uses zonal airflow network models. However it is limited to modelling simple airflow and nearly uniform temperature distributions. These limitations can only be overcome by coupling the model with CFD [Kalyanova, et al (2005)].

The lumped approach represents each façade and cavity with a single temperature. This approach was used by Balocco (2004) along with a nondimensional analysis that was used to describe the energy performance of several double skin façade designs. Moreover, Haddad and Elmahdy (1998); Park, et al (2004a); Park, et al (2004b); Von Grabe (2002); and Balocco (2002) used the lumped model for studying naturally ventilated facades [Jiru and Haghighat (2005)].

In the control volume approach, it is assumed that flow is one-dimensional and vertical. The temperature stratification in a ventilated façade is evaluated by dividing the façade into control volumes in the vertical direction. The mass transfer across each control volume can either be set using an the inlet value [Saelens (2002); Faggembauu, et al (2003a); Faggembauu, et al (2003b)] or be set using an airflow network model [Tanimoto and Kimura (1997)]. Holmes (1994) simplified the control volume model by using a linear vertical temperature variation in the ventilated cavity. The one-dimensional control volume model gives the vertical temperature stratification without any information on the distribution of airflow rate. Hence, the control volume thermal models are similar to the non-pressure zonal models, which are used to predict temperature stratification in the room. Therefore, in order to enhance the prediction capability of the control volume models without considerably increasing model complexity, they can be modified to model both airflow and temperature distribution in the DSF system. Such modifications of the control volume models can be achieved by using the power-law zonal model [Jiru and Haghighat (2005)].

Airflow network models have been used with energy simulation to evaluate the possibility of using natural ventilation for double-skin façade office buildings [Gratia and de Herde (2004a); Gratia and de Herde (2004b)], and energy performance of office buildings with double-skin façades [Gratia and de Herde (2004c); Hensen, et al (2002); Stec and van Paassen (2005); Saelens (2002); Jiru and Haghighat (2005)].

Detailed studies have also been conducted using CFD and experiments for mechanically ventilated facades [Manz, et al (2004)], naturally ventilated facades [Manz (2004); Zoller, et al (2002)], and ventilated facades equipped with Venetian blinds [Safer, et al (2004); Jiru and Haghighat (2005)].

The numerical and experimental studies mentioned above have been used to show the effects of different parameters on the performance of double-skin facades. Park et al. (2004b) used a lumped model to investigate occupant responsive optimal control of the double-skin façade, which accounts for energy use, visual comfort and thermal comfort using a calibrated lumped model. Furthermore, an experimental and numerical study by Saelens (2002) has shown that the location of the inlet air, the position of the thermal break, airflow rate and airflow distribution are important parameters that affect the performance of a DSF [Jiru and Haghighat (2005)].

Simulation studies by Gratia and De Herde (2004c) have also shown that the position of the façade and the direction of the wind can influence the relative importance of the stack effect for naturally ventilated DSF during the day. Moreover, Zoller, et al (2002) have also

conducted a parametric study for a naturally ventilated façade. They have shown that for a given cavity width, a change to the height of the inlet and outlet has no significant effect on the airflow rate in the cavity. However, the airflow rate increases with increasing cavity width for constant inlet and outlet height [Jiru and Haghighat (2005)].

The use of CFD codes requires specific expertise; its features are too sophisticated and unnecessary for the design stage, and so they are usually not suitable for designers. For this reason only available simulation software will be considered in this report.

2.7.1. Component simulation tools

To date there is a poor availability of design tools specifically created for the analysis of ventilated façades. Available tools for the design and analysis of DSF that are tailored for designers and consultants are listed below:

- WIS [Perino, M (2005)]

WIS is a well known software tool, useful for the study and design of glazed façades.

The following description of the software can be found in Van Dijk (2003) and in Van Dijk and Goulding (1996).

WIS is a European software tool for the calculation of the thermal and solar properties of commercial and innovative window systems on the basis of known component properties and thermal and solar/optical interactions between the components.

With WIS it is possible to describe the façade structure in combination with glazing and shading devices. Each “solid” layer (glass or solar shading device) must be separated from the adjacent one by an air cavity. The air cavity can be closed, naturally ventilated or mechanically ventilated.

Information about each component is stored in a database. This data includes, for instance, spectral optical properties of the available commercial glazing and shading devices as well as the thermal properties of edge spacers and of window frame profiles on the market.

Of course, it is very important to have a database as wide as possible, since there are a large number of commercially available products.

During the summer of 2002, WIS achieved an agreement with all major flat glass producers in Europe. In this way a very large data set of the optical properties of non-scattering glazing were obtained. The wish of the *WINDAT* consortium (Windows as Renewable Energy Sources for Europe – Window Energy Data Network, supported by DG for Energy and Transport of the European Commission) is that WIS will be collectively supported and used in research, industry, standardisation, education and design to compare, select and promote innovative windows and window components. This European database is compatible with a similar existing database in the USA.

Through WIS it is possible to simulate a complete window system. WIS models the one-dimensional window system by assuming uniform and steady conditions over the glass pane and assessing the temperature distribution and heat fluxes across the various layers (glass, solar shading, air).

A more detailed description of the software and its capability is given in Perino (2005) and by Dijk, et al (2003).

The main outputs provided by the WIS software are: the overall thermal and solar properties of the window system, the thermal and solar properties of each component, and the surface and centre (average) temperature of each layer, according to the

different incident angles of solar radiation. It should be noted that the thermal analysis may only be performed for steady-state conditions.

For more information, support and free download, visit: <http://www.windat.org>.

- BISCO/TRISCO/VOLTRA [Flamant, G, et al (2004)]
Developed by the Physybel company (<http://www.physibel.be>), this tool has the potential to calculate both temperature distribution and heat loss in the façade. The interaction between the glass, the shading layers and the thermal bridging effect of the subcomponents around the DSF (supporting mullions and transoms, connections between inlet and outlet openings, etc.) can be modelled.
- OPTIC5 [Lee, et al (2002)]
OPTIC5 can be used to determine the optical and radiative properties of glazing materials. For more information visit: <http://eetd.lbl.gov/btp/software.html>.
- FRAME
This modelling tool can be used to determine glazing U-value, SHGC, light transmission and glazing temperatures under any set of conditions that may be used for ventilated windows (<http://www.frameplus.net>).

2.7.2. Building simulation tools

Building simulation tools may be used to analyze ventilated façades as an integral building component. These tools, however, are suited for a “whole building approach”, and so they are much more useful for the analysis of the energy implications due to the use of a ventilated façade. They do not appear to be effective for the study and design of the façade component itself.

Building energy consumption can be assessed by simulating the building with software packages. At the moment there are more than 240 simulation software packages available that have been in existence for more than 20 years and evaluated by comparison with the monitored data for the performance of existing buildings [Clarke (2001)]. A good list can be found on the US Government’s Department of Energy website at: http://www.eere.energy.gov/buildings/tools_directory.

It is not easy to determine the most suitable software. The process is always a compromise between availability, purpose, ease of use and required accuracy [Hensen and Nakahara (2001); Morbitzer (2003)].

A short list of the most representative building simulation tools is presented below:

- CAPSOL [Flamant, G, et al (2004)]
Developed by the Physybel company (<http://www.physibel.be/>), this tool calculates multi-zone transient heat transfer as a function of heat fluxes (solar radiation and internal gains) and controls (heating, cooling, mechanical ventilation and shading).
- TRNSYS [Flamant, G, et al (2004); Crawley, D, et al (2005)]
This tool has been in use for more than 25 years to simulate the dynamic thermal behaviour of the building and systems. The modular approach includes a graphical interface, a simulation engine and an extensive library of components. This software can be coupled with COMIS (<http://epbl.lbl.gov/COMIS/>), thus allowing for multizone airflow analysis.
(<http://sel.me.wisc.edu/TRNSYS/> or <http://www.transsolar.com>)
- ESP-r [Flamant, G., et al (2004) ; Crawley, D, et al (2005)]
ESP-r is an open source program developed by the University of Strathclyde, Glasgow, Scotland (<http://www.esru.strath.ac.uk>). It’s a transient energy simulation

program capable of modelling the energy and fluid flows within combined building plant systems when constrained by control actions and subjected to dynamically varying conditions.

- TAS [Flamant, G., et al (2004)]
TAS is a suite of software products that simulate the dynamic thermal performance of buildings and their systems, accessing environmental performance, conducting a natural ventilation analysis, etc. The main module (A-TAS, building designer) performs a dynamic simulation with integrated natural and forced flow. The module may also be coupled with HVAC systems and a controls module (TAS Systems). A third module (Tas Ambiens – 2D CFD) produces a cross-section of micro climate in a space. (<http://ourworld.compuserve.com/homepages/edsl>)
- ENERGYPLUS [Crawley, D., et al (2005)]
EnergyPlus is a new-generation building energy simulation tool based on DOE-2 and BLAST, with numerous added capabilities, including the possibility of third party module and interface development. It is a modular system that is integrated with a heat balance based zone simulation that models multi-zone airflow (through fully integrated COMIS), radiant heating and cooling and PV simulation. WINDOW5 and Delight algorithms are embedded in EnergyPlus for façade modelling. Delight uses a radiosity-based method for internal reflections and a bidirectional transmittance function approach for transmission through complex fenestrations. There are limitations to modelling DSF with this software. Particularly, it is difficult to model cavity placed shading devices.
(<http://www.eere.energy.gov/buildings/energyplus/>)
- ECOTECH [Crawley, D., et al (2005)]
ECOTECH is a highly visual and interactive whole building design and analysis tool that links a comprehensive 3D modeller with a wide range of performance analysis functions. Thermal energy, lighting, shading, acoustics, resource use and cost aspects can be simulated and analyzed. Since this program is able to handle geometries of any size and complexity, it is tailored for holistic approaches to the building design process. ECOTECH shows particular capabilities to modelling certain glazing and fenestration problems. This program imports/exports data in conjunction with other tools like RADIANCE, EnergyPlus, ESP-r, etc.
(www.ecotec.com)

A joint report by the US DOE, the University of Strathclyde and the University of Wisconsin comparing 20 building simulation tools can be found in Crawley, D. et al, (2005). The conclusions to this report state that there is no common language to describe the capabilities of simulation tool, which leads to much ambiguity. It is further suggested that for the detailed design phase of a project, the use of a suite of tools may be preferable to the use of a single tool.

2.8. Available experimental procedures

A state-of-the-art review has led to the following conclusion regarding experimental procedures: there is no standardized procedure to certify DSF/AIF performance and to test the façade components.

With respect to design tools, the situation regarding the experimental procedures is fragmented and confined to a number of examples of studies performed mainly in different research centres but with some field monitoring.

Moreover, there is also a lack of knowledge about the type and definition of parameters to be used for façade classification, such as the U-value for traditional glazed systems. In fact, the usual U-value tends to be ineffective for ventilated façades, and for some working conditions it loses its physical meaning.

Some experimental test rigs have been proposed and built for DSF/AIF testing. One example is that of PASLINK EEIG (European Economic Interest Grouping), a high quality network of outdoor test centres for the testing of advanced building components, supported by a data analysis and modelling group. One of the activities of the project is the outdoor testing of advanced glazing components, such as the supply window. The TWINS or Testing Windows INnovative Systems, have been designed and built at the Politecnico di Torino Dept. of Energy Technology (DENER). This test rig consists of two identical test cells, with one used as a reference (test cell A) that does not change during the experimental campaign and the other (test cell B) used to study different configurations of active ventilated façades. So far the system has been used to test the “climate façade” (accordingly to BBRI – 2002).

Another case is presented by Shang-Shiou (2001) who proposed a protocol for DSF testing using a pair of twin test cells. One test cell is equipped with a NV-OAC window and the other test cell is equipped with a MV-IAC window.

2.9. Availability of measured performances

The picture regarding the availability of measured performances is extremely non organic and a complete, systematic set of experimental data is not available to researchers, designers and consultants. This is clearly a consequence of the fact that there are no standardised procedures for testing DSF/AIF, as mentioned in Section 2.5.

Available measured performances are usually the result of “occasional” studies performed in the lab or results from field monitoring; almost all the available data sets come from the research community.

A few measurement studies that were identified referred to both test facilities and real buildings.

Among the first group three test facilities were identified. The PASLINK test facilities, located in Scotland and Belgium, are commonly used to determine thermal and solar properties of building façade components under real weather conditions [Flamant, et al (2004); Baker and McEvoy (2000)]. The Smart Façade Demo Unit (SF DU) is located at the Georgia Institute of Technology in Atlanta, Georgia, USA [Park, C-S (2004b)]. The third facility is TU Delft test cell [Flamant, et al (2004)].

Concerning real buildings *in situ* measurements, Blasco was found to have made acoustic measurements on three different DSF types in Germany. Details about the thermal characterisation of the Debis building, acoustic measurements on DB Cargo and Dusseldorf City Gate buildings, and cavity air flow measurements on the Dusseldorf City Gate building can be found in Loncour, X., et al (2004b) and Oesterle, E., et al (2001). A long term field monitoring of an actual façade was performed in Italy [Corgnati, et al (2003)]. A set of seasonal measurements were performed by Takemasa on a DSF building in Tokyo that had a HV system (NV integrated with A/C) [Takemasa *et al.* (2004)].

Several researchers conducted experimental tests to study airflow windows under varying constructions, orientations, and weather conditions. Detailed results can be found in the following publications: Brandle (1982), Tjelflaat (1985), Wright (1986), Barakat (1987), Yuill (1987), Haddad (1998 and 1999), Southall (2000), McEvoy (2003), Baker (2003), Etzion (2003) and Erell (2004).

Other references to measurement results may be found in: Boonyatikarn (1987) concerning radiant temperature and comfort, Gan (1997) concerning Trombe walls configuration effects on ventilation, Daniels (1997) showing NV cavity temperature data for various shading devices and Jones (1999) studying the possible influence of wind on a NV-DSF. Natural lighting measurements were also performed on the Berlaymont building in Brussels [Deneyer, A and N Moenssens (2004)].

2.9.1. Example of a laboratory measurement campaign

Two prototypes of air supply windows were tested at the BRE Scotland using the PASLINK test facility. The first experimental campaign was a part of the JOULE IMAGE Project and the second has been performed in the frame of the UK EPSRC project in collaboration with the University of Westminster.

The purpose of the tests was to:

- provide high quality data for the validation of CFD models,
- determine the characteristic performances of the window for different gap widths and ventilation rates, and
- assess the use of passive stack ventilation (PSV) as a means for driving ventilation through the air supply window.

The results of the experimental campaigns indicate that both the solar and heat transmission coefficients increase with increasing ventilation rate over the range of flow rates were tested. However, no significant differences between the transmission coefficients assessed for different gap widths could be identified. The assessment of the thermal transmission coefficients shows uncertainties of ~10%, mainly due to errors in the measurement of the temperature rise in the air gap of the window.

For test case A, the window was used as a heat recovery device. The overall efficiency of the window varies with ventilation rate, ranging from about 30% of the heat lost through window at a ventilation rate of about 20 m³/h to about 50-60% at a rate of about 50 m³/h. At the highest flow rate, the effective U-value of the window, estimated at the centre of the glass pane, is approximately 0.6 W/m²·K. This is a good performance as compared to a calculated U-value of about 1.4 W/m²·K for a traditional window with triple glazing. At medium to high air flow rates, the window reduces the ventilation heat load requirement of the test cell by 10%.

The preliminary results on Window B indicate improved performance; about 50% of the heat lost through the window is recovered at a ventilation rate of about 20 m³/h, a value that rises to about 80% at an air flow rate of about 50 m³/h. At the highest flow rate, the effective U-value of the window, estimated at the centre of the glass pane, is about 0.3 W/m²·K.

When the solar shading device is removed, the supply air window can contribute more significantly to reducing the ventilation load, with a solar thermal efficiency between 8-12% depending on ventilation rate for Window A.

The results showed that:

- Coupling the air supply window with passive stack ventilation provides an adequate means of driving ventilation.
- Satisfactory minimum levels of ventilation were achieved with low wind speeds.

- The ventilation air provided by the window is significantly warmer than the external air during day time operation.
- Significant reductions in the ventilation heat loss were achieved.

The objective of Shang-Shiou (2001) tests was to “provide experimental rules on the correct and acceptable way to investigate the behaviour of the double envelope system. In addition the ultimate goal is to increase the understanding of the thermal performance of the double glass façade system.”

The analysis was performed to evaluate the solar radiation heat removed by the ventilated cavity and the temperature difference (ΔT_{ga}) between the indoor glass surface and the indoor air. Test conditions were limited to solar radiation intensities over 1 kW/m^2 and outdoor temperatures over 16°C . Results show that the fraction of incident solar radiation heat removed by the MV and NV windows is 57% and 32.5%, respectively.

From the ΔT_{ga} data, the following conclusions were obtained:

- Surface averaged ΔT_{ga} values are higher for the NV window.
- The upper areas of the windows show the same behaviour, but on the lower areas this behaviour is reversed.

2.9.2. Example of field monitoring

Oesterle, et al (2001) presents the results of measurements made on the City Gate Building in Dusseldorf (C-NV-RAF/OAC type) and the Debis Headquarters in Berlin (MS-NV-Bf/OAC type).

The first measurement case was concerned with sound transmission from room to room via the corridor DSF, Figure 2.21.

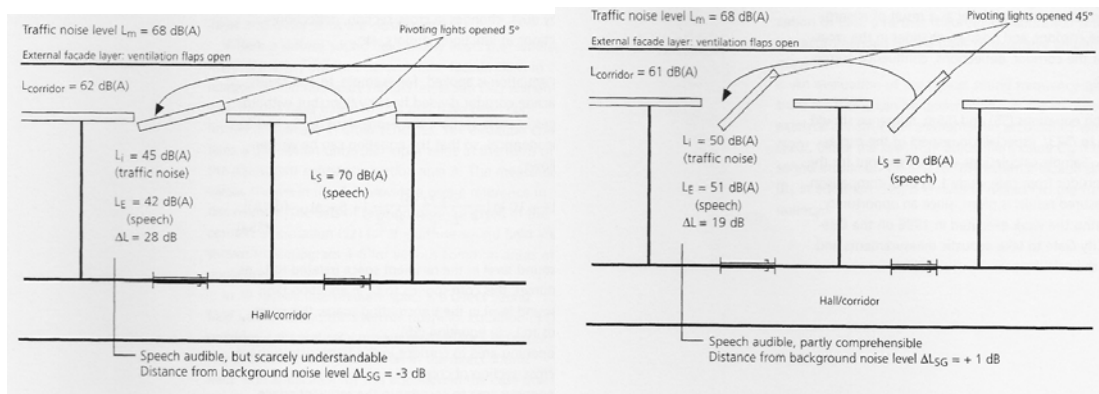

Figure 2.21. Measurement of sound transmission from room to room via the corridor DSF, with two opening angles [Oesterle, et al (2001)]

Measured sound level reductions from room to room were 28 dB(A) and 19 dB(A) for pivoting angles of 5° and 45° , respectively.

The second measurement case concerns the thermal and ventilation parameters of the DSF. Figure 22 illustrates the location of the measurement sensors and Figures 2.23 to 2.25 show the measurement results for the temperatures and air velocities within the gap.

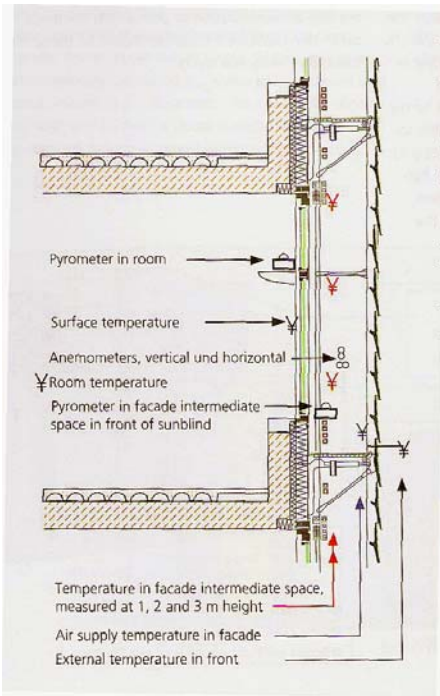

Figure 2.22. Location of sensors on the Debis Headquarters Building [Oesterle, et al (2001)]

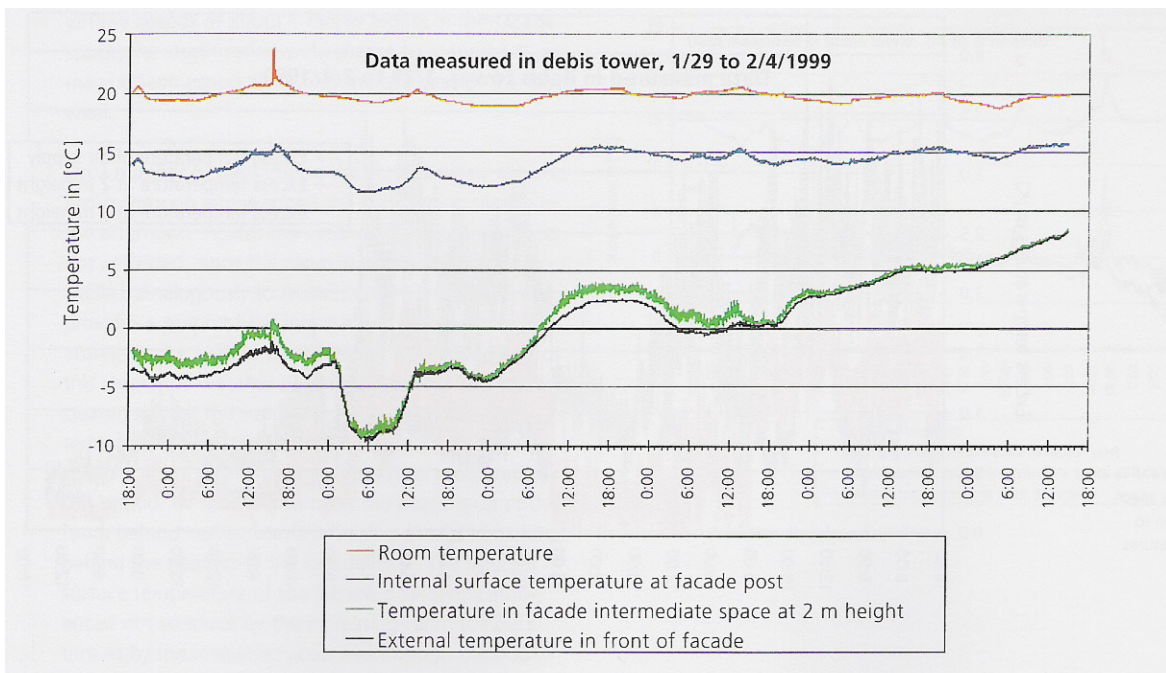

Figure 2.23. Temperatures on the Debis Headquarters Building [Oesterle, et al (2001)]

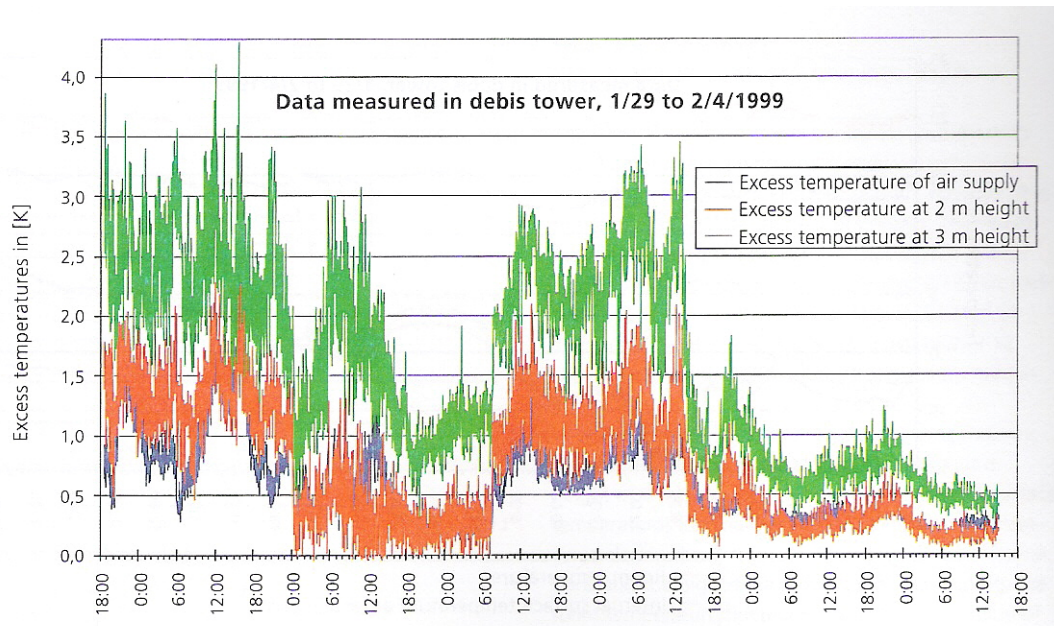

Figure 2.24. Excess temperatures from outside temperature on Debis Hdq. Building [Oesterle, et al (2001)]

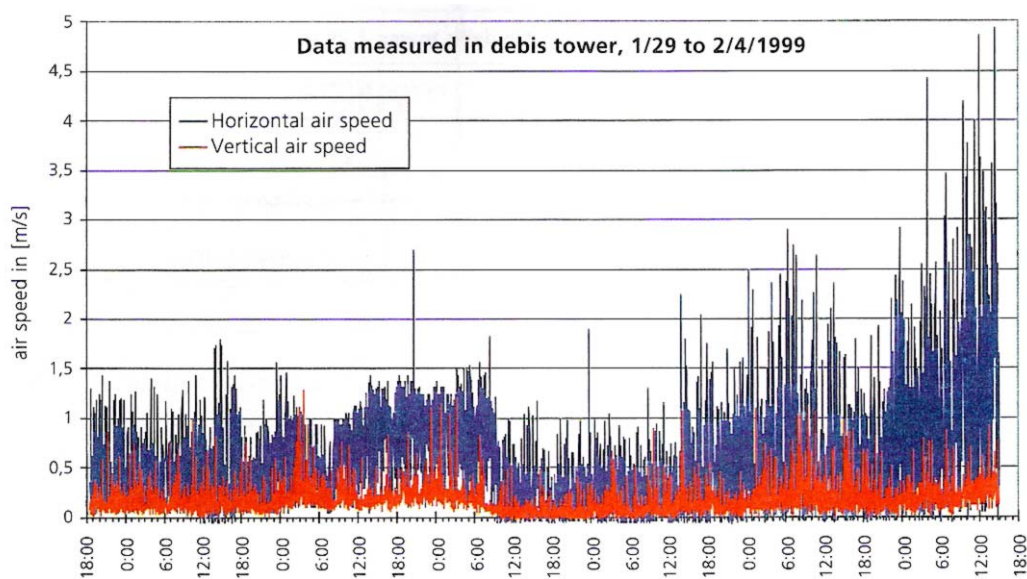

Figure 2.25. Horizontal and vertical air velocities on the Debis Headquarters Building DSF gap [Oesterle, et al (2001)]

The Department of Energy Technology of Politecnico di Torino has carried out a field monitoring of an existing “climate façade” (according to BBRI (2002)). The façade, which is integrated into the AHU, is used to exhaust the air from the environment. A heat recovery system allows for the pre-heating of the ventilation (outdoor) air.

Aims of the research were to analyse the behaviour and the performance of the façade during actual operating conditions.

The field measurement campaign has been done for two consecutive years. Analysis of the collected data has given insight into both the energy performance and the thermal comfort issues in a building using of a ventilated façade.

The structure of the monitored façade is shown on Fig. 2.26, together with the scheme of the sensors location and type.

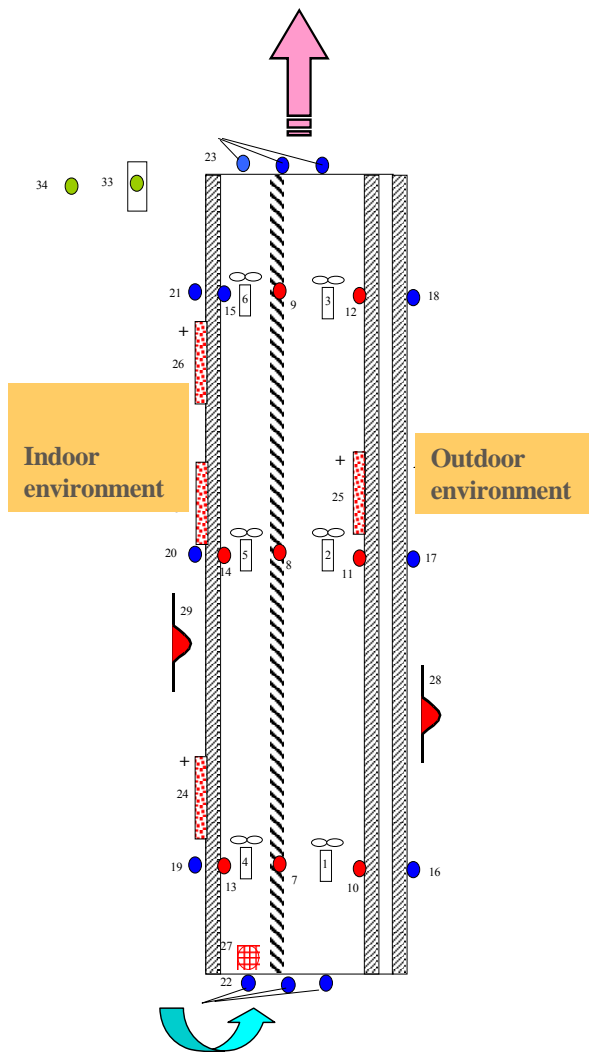

Figure 2.26. The monitored “climate façade” and the scheme of the experimental apparatus

Attention was focused on:

- the specific heat flux entering the indoor environment during the winter and summer,
- the pre-heating efficiency of the façade, and
- the internal glass surface temperature profiles during the winter and summer.

An example of a typical time profile for the heat fluxes during the winter period is shown on Fig. 2.27. It is possible to see that for low values of the irradiance (I), even when the mechanical ventilation is on, the heat fluxes through the inner glass (q_i) are always negative (i.e. exiting from the indoor environment). Note that the heat fluxes are constituted by two different components; one component is due to the temperature difference the other component is due to the absorbed and transmitted quota of the solar radiation.

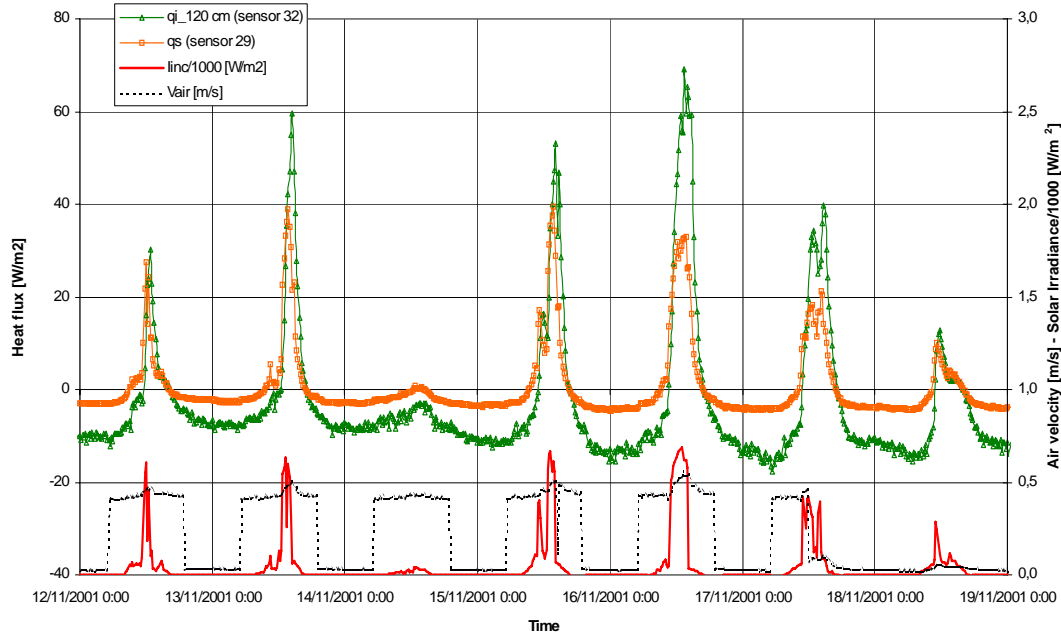

Figure 2.27. Heat fluxes during the winter period

Figure 2.28 shows the same profiles for a typical summer period. It is possible to see that during the hot seasons, when mechanical ventilation is on, the heat fluxes are sensibly reduced as compared to the “natural” ventilation configurations (i.e. HVAC system off). The façade is used as a heat recovery device during the entire winter part of the middle seasons. During these times the overall efficiency of the façade may be assessed by defining a suitable “pre-heating efficiency”:

where

$$\eta = \frac{T_{exh} - T_{int}}{T_{int} - T_{est}}$$

T_{int} = indoor air temperature

T_{est} = outdoor air temperature

T_{exh} = temperature of the air exhausted from the façade

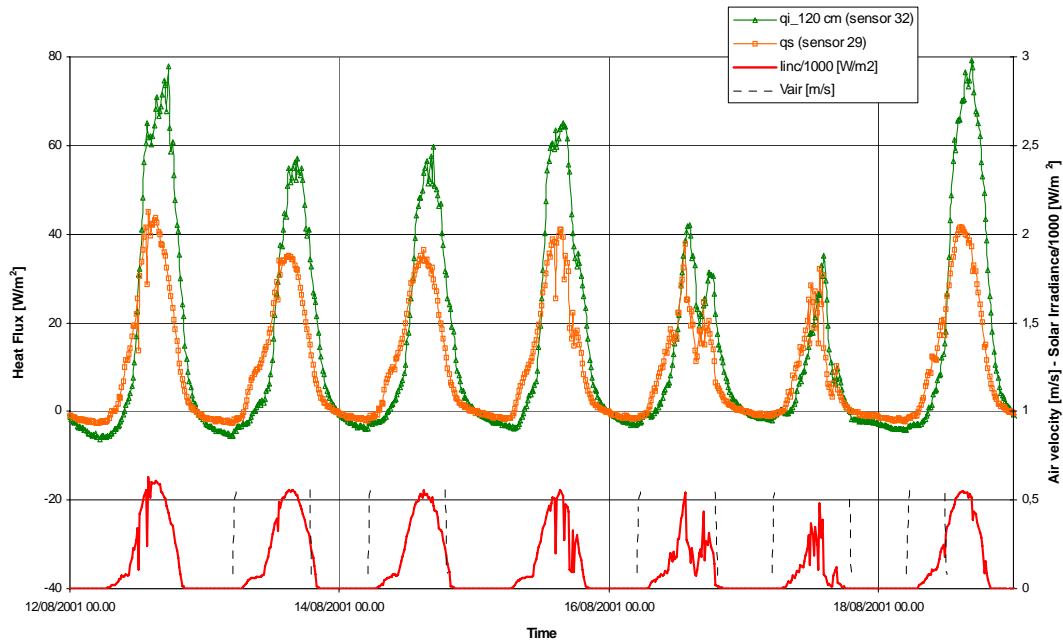

Figure 2.28 – Heat fluxes during the summer period

The pre-heating efficiency reflects the ability of the façade in pre-heating the ventilation air (outdoor air):

- $\eta < 0$

This occurs when ($T_{\text{exh}} < T_{\text{int}}$). The façade cools the indoor air at a temperature lower than the outdoor temperature and therefore only has a dynamic thermal insulation effect.

- $0 < \eta < 1$

The air is preheated at a temperature lower than the required (indoor) value.

- $\eta = 1$

The façade completely preheats the ventilation air, zeroing the ventilation losses.

- $\eta > 1$

The façade heats up the ventilation air at a temperature higher than the indoor temperature, and so there is a complete compensation of the ventilation losses and a partial compensation of the other thermal losses.

Figure 2.29 shows the frequency distribution of the pre-heating efficiency obtained during the monitoring campaign for two different ventilation conditions: low air flow rate (CF) and high air flow rate (SF). Quite poor performances are highlighted as far as the energy recovery is concerned. Preheating efficiencies are higher than 50% for only a small fraction of the working time.

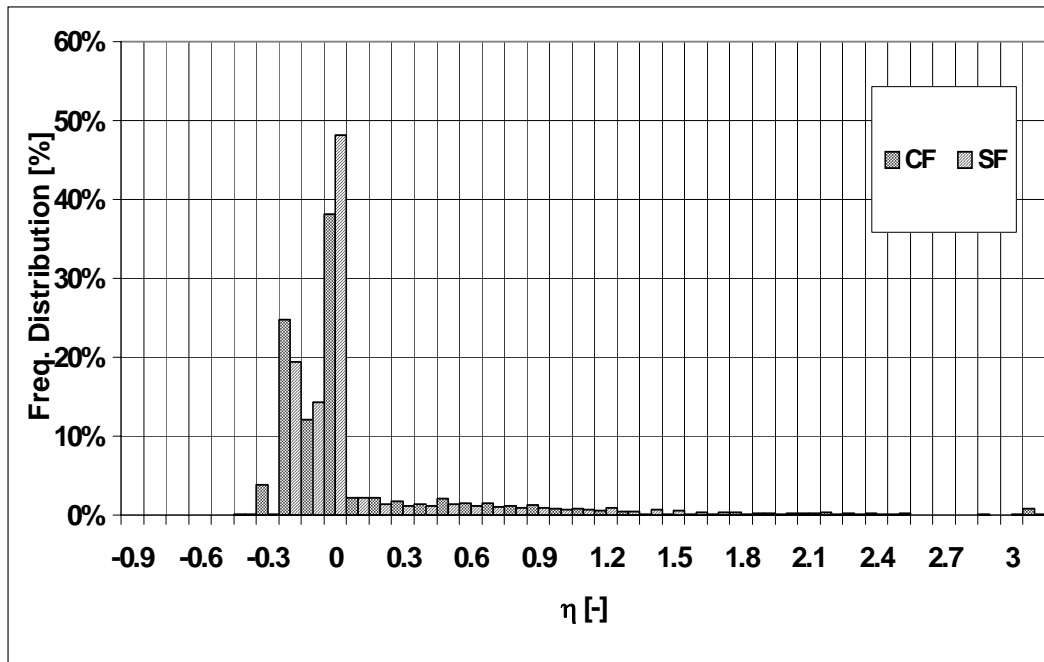

Figure 2.29. Frequency distribution of the pre-heating efficiency

As shown in Fig. 2.30, Takemasa, et al (2004) performed a set of *in situ* measurements on a ten storey building in Tokyo. The building was naturally ventilated with a corridor type DSF coupled to an A/C system, in order to evaluate the façade performance in summer months (July/August of 2002) and winter months (January/February of 2003). A hybrid solution was used in Spring (May of 2003 and 2004).

The east facing DSF has an outside pane of transparent single glazing and an inner pane of low-e double glazing with opening vents on the upper area of the panes from the 3rd to the 7th floor. The vents can be positioned in five increments from fully closed to fully open for air intake. The room cross ventilation air is exhausted by the air shafts inside the building.

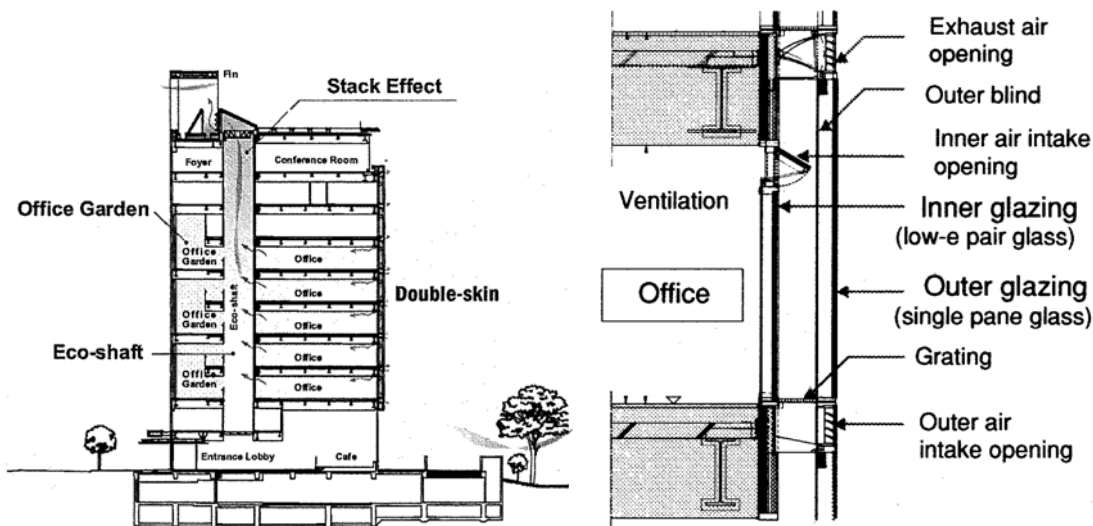

Figure 2.30. Sectional view of the building and a detail of the DSF

The coupling of the NV and A/C systems is provided by a sophisticated automatic control strategy that responds to outdoor conditions. Measured parameters are: outdoor conditions, indoor vertical air temperature distribution, indoor thermal radiative environment, surface

temperatures and air temperatures and velocity at the DSF exhaust vents. Figures 31 to 33 show some of the results from the measurement campaign [Takemasa, et al (2004)].

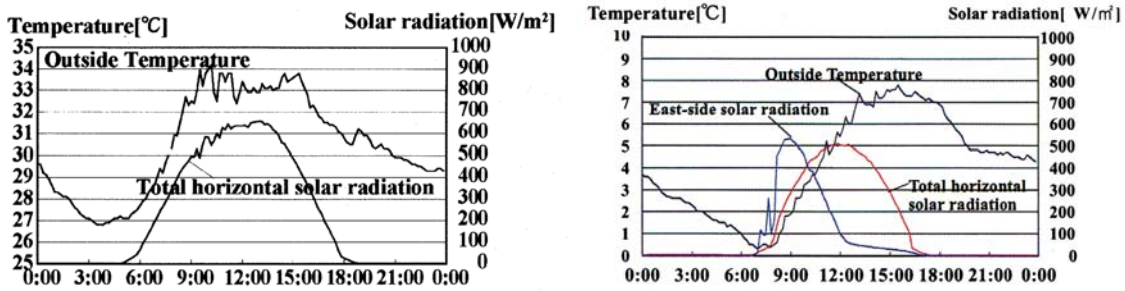

Figure 2.31. Outdoor conditions for summer (02/08/07) and winter (03/02/03)

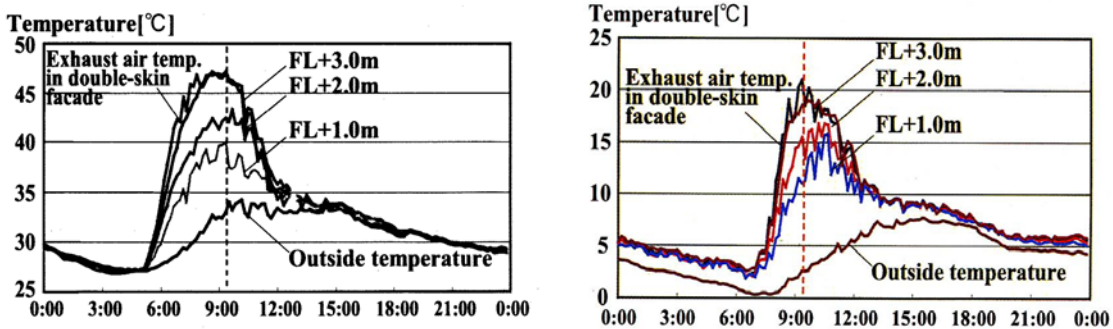

Figure 2.32. Air temperatures inside the DSF cavity for summer and winter

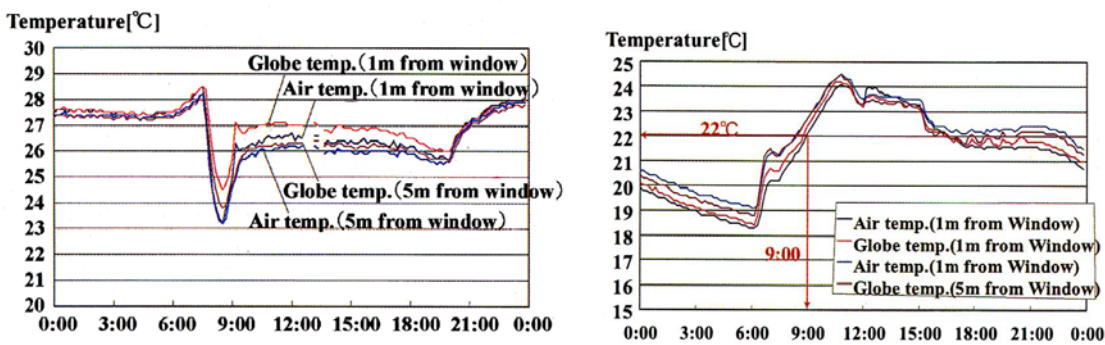

Figure 2.33. Indoor air and globe temperatures for summer and winter

Figure 2.34 shows the correlation between the vertical solar radiation on the east façade and the temperature difference between the DSF exhaust air and outside air.

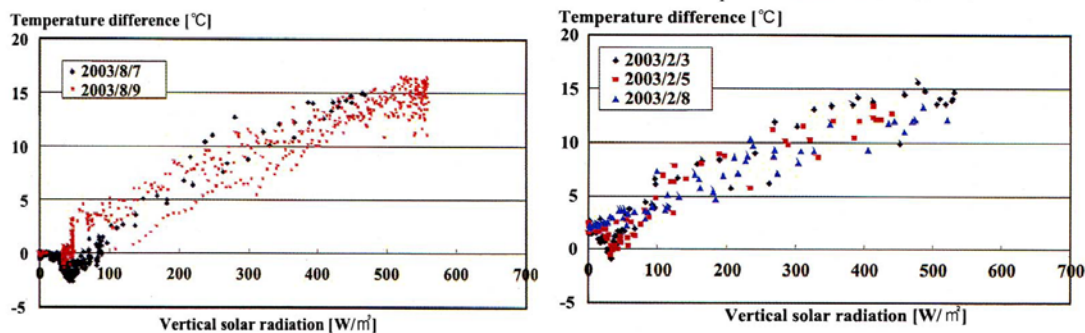

Figure 2.34. Correlation between vertical solar radiation and temperature difference for summer and winter

2.10. Availability of simulated performances

The situation concerning the availability of simulated performances is relatively similar to the one described for the measured performances; there are no systematic and comprehensive data sets available and the target for this information is mainly represented by researchers.

The number of examples available in the literature, however, is somewhat higher than that for the experimental studies. A significant number of tools were used that ranged from specially developed numeric schemes to current commercial ones.

Performed simulations may be grouped into the following categories:

- Application examples of commercial tools, such as the ones presented in Flamant (2004).
- Research simulations with no connection to any real building, which are by far the largest group. This includes such works as:
 - Hensen, et al (2002), which used a network approach fully integrated into a building thermal energy model to simulate a set of different configurations;
 - Li Mei, et al (2003), which used a dynamic thermal model based on TRNSYS to study a building with an integrated ventilated PV façade/solar air collector system located in different European areas;
 - Saelens, et al (2003), which analyzed the energy efficiency of different kinds of one-storey multiple-skin façades;
 - Balocco (2002) used a steady-state calculation model to study the energy performances of a naturally ventilated façade;
 - Van Paassen who has several published works on the subject;
 - Yin-Hao Chiu and Li Shao (2001) who investigated the energy savings that result from preheating the ventilation air with a naturally ventilated double skin façade. Simulations were conducted using a 3D CFD model;
 - Ciampi, et al (2003) who used a simple analytical method to calculate the energy saving achieved by using ventilated facades with air flow driven by the stack effect;
 - Faggembau, et al (2003) who developed a numerical code for accurate time-dependent simulations of the thermal and fluid dynamic behaviour of ventilated facades. Simulations modelled a typical ventilated façade over one year in Mediterranean climatic conditions;

- A number of ventilated window simulations performed by a large group of researchers on the last 20 years using a broad set of tools [Gosselin, JR (2005)].
- Real building simulations, such as:
 - The evaluation of natural lighting on indoor conditions using three different methodologies: BRE, NBNL 13-002 standard, and a simplified tool;
 - Takemasa, et al (2004) who simulated the DSF of a Tokyo building using a model based on the heat balance outlined in Figure 2.35.

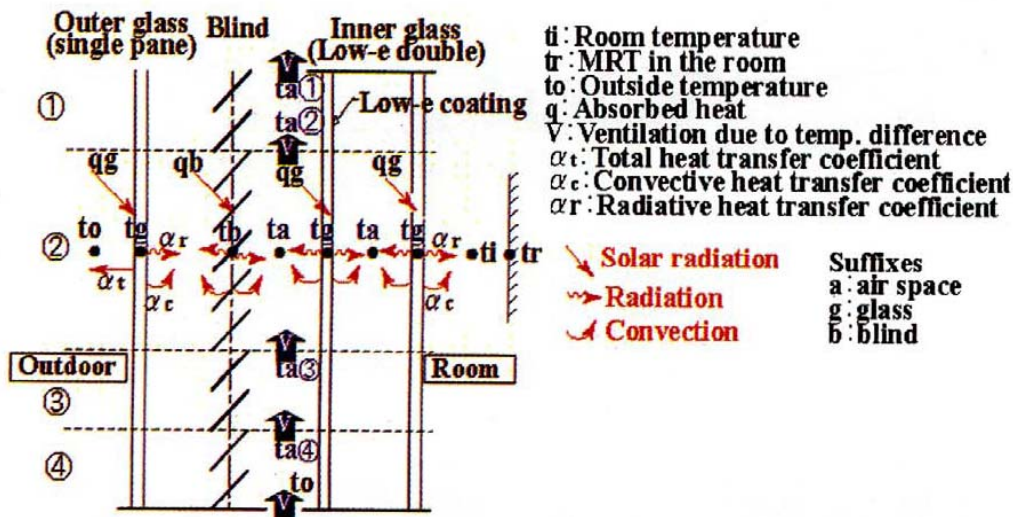

Figure 2.35 – “Window model” for a DSF façade [Takemasa, et al (2004)]

Figure 2.36 shows comparisons between measured and calculated values.

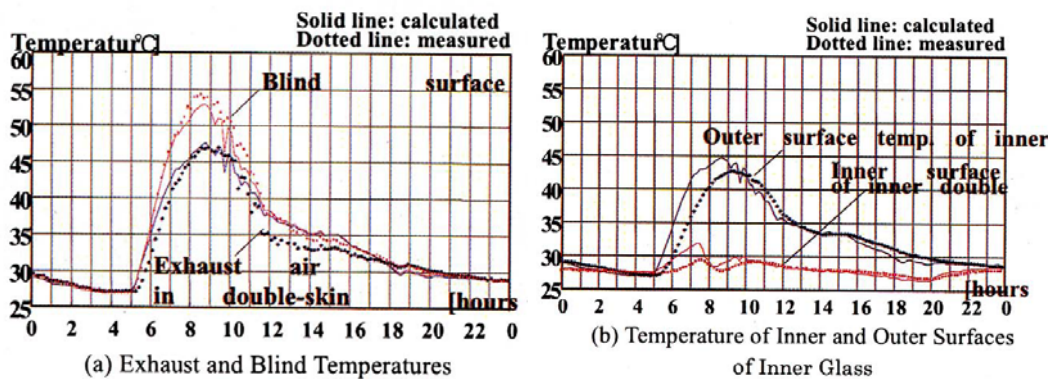

Figure 2.36. Comparisons between measured and calculated values

- Simulations for four buildings in Hong Kong with DSF were conducted using VisualDOE, [Haase, M (2005c)];
- Simulations (thermal and sound reduction) for two Norwegian buildings with DSF [Dokka, TH (2005)];
- Simulation of a building in Lisbon (C-NV-OAC) DSF with DOE-2 [Duarte, R et al (2005)].

2.11. “Claimed” benefits and possible limitations

The major “claimed” benefits of DSF/AIF have already been described in previous sections. A more detailed list of the benefits along with possible drawbacks is presented in Table 2.1.

Table 2.1 – List of possible benefits and drawbacks of DSF/AIF

	<u>BENEFITS</u>	<u>LIMITATIONS</u>
Acoustics	Offers better acoustical insulation against outdoor noise	External pane openings may reduce noise insulation but usually not in a significant way; Room to room sound transmission (“telephone” effect) is possible
Energy	May act as a static or dynamic thermal buffer, thus reducing heating/cooling energy needs; Heated cavity air may be used as input for A/C units.	High internal loads may require extra cooling energy, thus compensating the benefit of energy reduction; Sensitive to components change from design specification.
Ventilation	Improves the use of natural ventilation; Operable windows are allowed; Reduces cavity condensation	Mechanical ventilation HVAC systems may be needed to ensure thermal comfort; Pollutant dissemination is possible
Shading	Various types of solar shading device are possible due to the weather; Pollution protection is offered by the external pane	-----
Wind pressure	Protects the inner pane from gusting and reduces static pressure in high-rise buildings; Reduces the difficulty of operating windows/doors and the risk for maintenance staff	Cavity wind induced pressure depends on DSF/AIF configuration; Certain zones of the façade may not be protective; Heavy wind loading is possible
Lighting	Enables the installation of light redirecting elements; Improves the use of natural lighting with no thermal discomfort	Reduces the amount of daylight entering the building in comparison with single glazed façades
Fire safety	-----	The exterior glazing layer reduces the ability for smoke ventilation; The air gap increases the risk of fire/smoke spreading among floors or rooms; Reduces the ability of fire fighters to reach the inner façade; Increases the risk of broken glass

		hitting the ground
Cost	Lowers operation costs and may reduce overall costs, resulting in a more cost effective solution	Higher investment costs and maintenance costs; May increase overall costs, resulting in a less cost effective solution
Sustain-ability	May significantly reduce energy consumption; Higher lifecycle of weather protected elements, reducing waste; Improves adaptive comfort; Building refurbishment may be restricted to the façade	Higher materials input; Environmental impact depends on used materials; Improper design may significantly increase energy consumption

2.12. Future perspectives

An inquiry to designers presented in [Lee, E, et al (2001)] shows that the main reason for adopting AIF solutions is not “fashion” but the improvement in energy management towards consumption reduction that maintains indoor comfort levels.

In fact, over the last century, the construction of “usual” buildings has resulted in an increase in energy consumption, a result that is clearly unsustainable. Additionally, if climate change proves to be long-term and the world population continues to increase, then it means that more people may live in hotter climates. There is then a huge potential for cooling demands to be met by the current state of “usual” building construction. Innovative air conditioning techniques would be required. Population increase also implies the movement of people to urban areas and the obvious need for the increase in energy consumption of presently low demand countries.

To prepare for the future, the building sector has to be much less energy demanding. It also has to be fully adaptive to the local climate and, of course, be environmentally sustainable and cost effective. Within this framework, as stated in Wigginton (2002), the façade will be one of the principal elements in the buildings of the future.

To fulfil such a challenge, there is a need for teamwork from the onset of building design. Architects and engineers must educate investors and owners for decision making and occupants for use.

In order for AIF solutions to be conveyed, designers need guidelines in the form of simplified tools, standards and regulations, updated and more reliable tools for more advanced design stages, and specific benchmarks. This could possibly be the outcome of the EU BESTFACADE programme (see <http://www.bestfacade.com>).

Investors and owners tend to demand an “operational warranty” concerning the energy/comfort performance post-occupancy. This may be connected to the lack of confidence on the pre-occupancy results produced by simulation tools. To reach higher levels of confidence, validation is mandatory, and the monitoring of real buildings post-occupancy is necessary.

The increase in adaptive comfort use means not only design capability but also occupant education in order to clarify working principles and the consequences of individual action on the system. Buildings with integrated systems should provide manuals to the occupants that outline operation guidelines.

2.13. Barriers to application

Barriers to DSF/AIF implementation mainly arise from several factors. In this section, the most significant factors are reviewed in an extended way.

2.13.1. Costs

Costs result from two main sources: investment and maintenance. For comparison, the costs of a DSF/AIF are usually compared to the ones related to a single glazed façade (SGF). This results in a cost-benefit analysis.

Construction investment on a DSF is always higher due the extra pane material and installation devices. It is also due to the need for fire protection systems within the cavity, with the exception being room sized glazing.

Maintenance costs to be considered belong not only to the DSF/AIF itself but also to the influence it has on related building systems such as lighting and HVAC [Magali and Gratia (2002)].

An overview of the sources of added costs is presented below:

- DSF/AIF maintenance costs
Cleaning costs are highly dependent on the cleaning frequency of the shading device (assuming that SGF has always external devices). Magali and Gratia (2002) found that for a SGF with shading that is cleaned on the recommended yearly basis, the DSF costs are significantly lower. This is because DSF shading only needs to be cleaned every 4-5 years. However, yearly cleaning in SGF is seldom done, which immediately reduces costs to a level lower than that for buildings with DSF for periods longer than two years.
- Building systems maintenance costs
Lighting maintenance shows no difference from SGF.
HVAC systems may be reduced but maintenance dependent on load is minor or non existent.
- Fire protection (sprinklers) within the DSF cavity represents 2-3% of its investment costs.

Although the user may spend more on first costs, but this extra cost may then be recovered depending on the energy saving achieved. However, it is difficult to have a clear figure for the pay back period of the investment.

The increase in indoor thermal comfort is also difficult to assess and is frequently far lower than expected. Moreover, it is difficult to quantify this increase. For example, it is hard to find the monetary equivalent for the increase in productivity of the occupants and or the increase of the floor area that can be occupied as a result of better thermal comfort.

Cost-benefit evaluation depends on financially measurable aspects (construction, energy cost), which are dependent on objective criteria and not economically quantifiable (noise reduction) and subjective criteria (aesthetics). The last two aspects need decision support methods to be evaluated and compared with each other in an *a priori* incomparable process [Flamant, et al (2004)].

A performance evaluation usually needs a reference. The choice of a reference building is crucial because although a poorly performing one enhances its qualities, the reverse is also true.

In order to convince end users to adopt a DSF/AIF, the manufacturers tend to keep the façade costs as low as possible by using, for example, poor performing glass panes (clear glass) and solar shading devices. While these actions lead to relatively cheap façades, they also frequently compromise the efficiency and performance of the façade itself.

2.13.2. Fire standards and regulations

Fire regulation may be a further concern due to the fact that no specific standards or regulations exist for DSF. This leads to interpretation and application problems.

Such regulations, as in Italy for example, forbid the use of building envelope technologies that put into direct connection more than two stories. Also, in Belgium, this rule may be overruled by the government based on a report from the fire services or a study bureau that proves that an equivalent safety degree is obtained by alternative strategies [Loncour, et al (2003); Martin and Loncour (2004)].

With respect to fire resistance, there are EU standards to test construction products that are applicable to DSF/AIF elements. The Commission Decision 2000/367/EC mentions the classification of resistance to fire by external walls, which includes curtain walls and glazed elements [Loncour, et al (2003)]. The same authors specify in EN 13830 (curtain wall – product standard) three guidelines concerning fire prevention:

- EN 13501-1:2002 for fire reaction classification of construction products. A specific fire scenario is being developed for testing façades.
- prEN 13501-2:2002 for fire resistance classification of construction products and building elements, from fire resistance tests. Curtain walls shall be tested according to EN 1364-Part3 and parts of curtain walls shall be tested according to EN 1364-Part4.
- Fire propagation is referenced in EN 13830 mentioning that precautions should be taken to prevent the transmission of fire and smoke through voids in the curtain wall construction. Fire and smoke stops shall be incorporated at all levels with structural floor slabs. However no standard, test methods or alternatives are given to avoid transmission of fire and smoke through the cavity.

It is well worth it to present here the opinion established by the Swiss Cantonal Association of Fire Insurances (<http://ppionline.vkf.ch>) on this subject:

There is no test expertise allowing one to know how a fire develops in a DSF building, being certain that they constitute a huge problem both from protection and fire fight points of view, because

- it makes it difficult to see the fire and the people in danger from the outside,
- it prevents combat from the exterior particularly on early stages,
- thermal destruction, if any, only occurs on late stages depending on the type of glass used,
- loss of broken glass and construction parts endangers fire-fighters, namely on late stages,
- if cavity partitions are not fireproof, dissemination will be fast,
- combustible materials in the cavity, such as shading, contribute to fire propagation, and
- less powerful fires smoke dissemination can be generalized by ventilation openings.

Due to the lack of specific regulations for DSF buildings, fire protection for people and property cannot be applied. For people protection a safety level equal to the SGF should be mandatory. The minimum complementary measures for DSF (adapted from the Swiss Fire-fighters Federation agreement) are:

- No combustible materials for the inner pane, except for window frames where it may be allowed, and for external panes except for sealants and bonds. This should be applied to refurbishment evolving the addition of a double-skin,
- Full interdiction of combustible materials for shading devices,
- EI60 class protection between the cavity and ventilation plenum above ceiling,

- Escape ways should not use the cavity. If the cavity is usable (corridor type), access to the interior should be previewed. In other words, doors with the same fire resistance of the inner pane should be used.

In Belgium a task force was formed within the National Council for Safety Against Fire and Blast to propose regulations for fire safety on DSF buildings [(Martin and Loncour (2004)]. A brief summary of their proposal follows:

- Experience shows that an automatic sprinkler-like system is more efficient than fire dampers on every storey in preventing or retarding fire propagation. Multi-storey DSF with such systems and smoke exhaustion in the cavity do not need fire dampers. Inner pane glass should be tempered. An alternative consists on automatically opening the external pane, thus avoiding the stack effect. In this case, the inner pane should follow SGF safety rules. If this is not possible, the inner pane should have a fire resistance class of: a) E60 full length; b) EI30 full length, or; c) EI60 every two stories.
- Partitioned cavities are acceptable if the partitions are of E60 class.

2.13.3. Construction regulations and laws

Local and country regulations concerning taxes and building permissions may also have an influence on application. In Italy the space comprised between the two skins is considered to be a “built environment”. This means that the use of a DSF determines an increase in the gross volume of the building and implies problems with the “urban indices” and results in an increase in the due taxes without the advantage of having usable “walking” area for the occupants.

2.13.4. Lack of knowledge and lack of design tools

As previously stated the confidence on simulation results will become more and more essential as contractors demand that cost effectiveness and claimed comfort conditions be evaluated in post occupancy and be included in “warranty”.

The lack of specific models for AIF behaviour may therefore slow the use of those kinds of solutions.

2.14. Open questions and future research work to be completed

From Table 2.1 it is possible to see that there are many “cons” to using DSF/AIF in a building. Furthermore, many of the available results obtained from field measurements point out that the DSFs frequently performed worse than expected.

This does not necessarily mean that the technology is not working. Instead, this may be a reflection of an incorrect design and/or integration with the building and the HAVC system, an explanation that has been substantiated by studies of the performance of existing ventilated facades.

It can be said that the technology is promising, but it is still quite young. Therefore such RBEs need further development before their performances become satisfactory.

As a result many research activities are needed in the area of DSF/AIF. The main points that have to be investigated are the:

- establishment of a standardized procedure for the experimental investigation of DSF/AIF
- definition and measurement of performance indices that can be easily and clearly assessed,
- development of a complete library of field measurements in order to deepen the knowledge about the DSF/AIF behaviour and performance,
- optimisation of the façade integration both with the building and the HVAC system, and with particular emphasis on a ventilation strategy that would avoid the overheating of upper floors,
- development of numerical models for the simulation of DSF/AIF
- development of design tools for architects and consultants
- set-up of cost assessment procedures that take into account both first costs and management costs,
- optimization of the existing DSF/AIFs and, eventually, development of new and more efficient components,
- development of tools for the integrated analysis of the DSF/AIF and the building,
- use of different/innovative materials for constructing the DSF/AIF,
- extension to residential buildings, and
- development of alternative schemes of fire safety.

2.15. References

- AEAI (VKF) (2001). "Note explicative de protection incendie 1004. Mesures de protection incendie pour façades double-peau." Association des établissements cantonaux d'assurance incendie, Berne, Suisse. (<http://ppionline.vkf.ch>)
- Allocca, C, Chen, QY and LR Glicksman (2003). "Design analysis of single-sided natural ventilation." *Energy and Buildings*, 35(8): 785-795.
- Amato, A (1996). "A Comparative Environmental Appraisal of Alternative Framing Systems for Offices." Oxford Brookes University UK, Oxford.
- Andersen, KT (2003). "Theory for natural ventilation by thermal buoyancy in one zone with uniform temperature." *Building and Environment*, 38(11):1281-1289.
- Aschehoug, Ø, et al (2000). "BP Amoco Solar Skin – A Double Façade With PV." *Proceedings of EuroSun 2000, Copenhagen*.
- Aschehoug, Ø and D Bell (2003). "BP Solar Skin – A facade concept for a sustainable future." *SINTEF Report, Trondheim*.
- Aschehoug, Ø and A Wyckmans (2003). "BP Solar Skin – Occupant surveys before and after the construction of prototype." *SINTEF Report STF50 A05079, Trondheim*.
- Aschehoug, et al (2005). "Double facades at high latitudes – some user experiences." *Paper at the International Conference Glass in Buildings, April 7-8, Bath, UK*.
- Baker, JA and R Henry (1997). "Determination of size-specific U-factors and solar heat gain coefficients from rated values at established sizes - A simplified approach." *ASHRAE Transactions*, 103 (1):1021-1025.
- Baker, PH and ME McEvoy (2000). "Test cell analysis of the use of a supply air window as a passive solar component." *Solar Energy*, 69(2):113-130.
- Baker, P, et al (2003). "Improving air quality in homes with supply air windows." *Draft BRE Information Paper for a DTI Partners in Innovation Project: Guidelines for implementation of an innovation whole-house ventilation system and its comparison with established approaches to house ventilation*.
- Balocco, C (2002). "A simple model to study ventilated facades energy performance." *Energy and Buildings*, 34(5):469-475.
- Balocco, C (2004). "A non-dimensional analysis of a ventilated double façade energy performance." *Energy and Buildings*, 36:35-40.
- Barakat, SA (1987). "Thermal performance of a supply-air window." *Proceedings of the 12th Annual Passive Solar Conference*, 12:152-158.
- Belgian Building Research Institute (BBRI) (2002). "Source book for a better understanding

- of conceptual and operational aspects of active facades." Department of Building Physics, Indoor Climate and Building Services, BBRI, Belgium. (<http://www.bbri.be/activefacades/>)*
- Belgian Building Research Institute (BBRI) (2004). "Ventilated double facades. List of buildings equipped with ventilated double facades." Department of Building Physics, Indoor Climate and Building Services, BBRI, Belgium. (<http://www.bbri.be/activefacades/>)*
- Bodart, M and DH, A (2002). "Global energy savings in offices by the use of daylight." Energy and Buildings, 34(5):421-429.*
- Boonyatikarn, S (1987). "Performance of an air-flow envelope." Proc. 12th Passive Solar Conference.*
- Brandle, K and RF Boehm (1982). "Airflow windows: performance and applications." ASHRAE/DOE Conference, Proceedings of Thermal Performance of the Exterior Envelopes of Buildings II. Las Vegas, NV.*
- Chen, Q and J Van Der Kooi (1990). "A methodology for indoor airflow computations and energy analysis for a displacement ventilation system." Energy and Buildings, 14(4):259-271.*
- Chen, Q and W Xu (1998). "A zero-equation turbulence model for indoor airflow simulation." Energy and Buildings, 28(2):137-144.*
- Chiu, Y and L Shao (2001). "A parametric study of solar double skin façade on energy saving effect." Proceedings of the 7th Clima 2000 World Congress, Napoli, Italy.*
- Ciampi, M, Leccese, F and G Tuoni (2003). "Ventilated facades energy performance in summer cooling of buildings." Solar Energy, 75:491-502.*
- CIBSE (2002). Code for lighting. Butterworth-Heinemann, Oxford, UK.*
- Clarke, JA (2001). Energy simulation in building design. Butterworth-Heinemann, Oxford, UK.*
- Clements-Croome, D (1997). Naturally ventilated buildings, E&FN. Spon, UK.*
- Compagno, A (2002). "Intelligente Glasfassaden: Material, Anwendung, Gestaltung = Intelligent glass facades: material, practice, design." Intelligent glass facades, Basel; Boston:183.*
- Corgnati, SP, Perino, M and V Serra (2003). "Energy performance evaluation of an innovative active envelope: results from a year round field monitoring." Proceedings of the 2nd International Conference on Building Physics, September 14-18: 487-496.*
- Corgnati, SP, et al (2004). "Performance of a transparent active façade in terms of thermal comfort: experimental assessments." Climamed – Congresso Mediterraneo de*

Climatização, Atti del Congresso su CD-ROM, 16 e 17 Abril de 2004, Lisboa.

- Crawley, DB, et al (2005). "Contrasting the capabilities of building energy performance simulation programs." Joint report by US Dept of Energy, Un of Strathclyde (Scotland, UK) and Un of Wisconsin (USA). (www.energytoolsdirectory.gov)*
- Daniels, K (1997). "The technology of ecological buildings. Basic principles, examples and ideas." Birkhauser, Berlin.*
- Deneyer, A and N Moenssens (2004). "Les doubles façades ventilées. Analyse quantitative coûts-bénéfices de l'utilisation de doubles façades ventilées. Comportement à la lumière naturelle des doubles façades ventilées à lamelles. Illustration sur base de mesures réalisées dans le bâtiment Berlaymont." CSTB. (<http://www.bbri.be/activefacades/>)*
- Van Dijk, D and H Oversloot (2003). "WIS, the European tool to calculate thermal and solar properties of windows and window components." 8th Int IBPSA Conf, Eindhoven, Netherlands.*
- Duarte, R, et al (2005). "Glazing-related problems due to high temperatures in double skin façades." CISBAT 2005, Lausanne, Switzerland.*
- Etzion, Y and E Erell (2003). "Controlling the transmission of radiant energy through windows: a novel ventilated reversible glazing system." Building and Environment, 35(5):433-444.*
- Erell E, et al (2004). "'SOLVENT': Development of a reversible solar-screen glazing system." Energy and Buildings, 36(5):467-480.*
- Ferguson, JE and JL Wright (1984). "VISION: A computer program to evaluate the thermal performance of super windows." NRC Canada, Report No. Passive-10.*
- Faggembauu, D, et al (2003a). "Numerical analysis of the thermal behaviour of glazed ventilated facades in Mediterranean climates. Part II: applications and analysis of results." Solar Energy, 75:229-239.*
- Faggembauu, D, et al (2003b). "Numerical analysis of the thermal behaviour of ventilated glazed facades in Mediterranean climates. Part I: development and validation of a numerical model." Solar Energy, 75:217-228.*
- Flamant, G, Heijmans, N, and E Guiot (2004). "Determination of the energy performances of ventilated double facades by the use of simulation integrating the control aspects - modelling aspects and assessment of the applicability of several simulation software. Final Report." Belgian Building Research Institute (BBRI), Department of Building Physics, Indoor Climate and Building Services. (<http://www.bbri.be/activefacades/index2.htm>)*
- Flamant, G, et al (2004). "Real-scale testing of ventilated double façades. Performance assessment in a PASLINK test cell." Belgian Building Research Institute (BBRI), Dept of Building Physics, Indoor Climate and Building Services.*

(<http://www.bbri.be/activefacades/index2.htm>)

Fracastoro, GV, Giai, L and M Perino (1997). "Reducing cooling loads with under roof air cavities." *18th AIVC Conference, Atene, September 23-26, Vol. II:477-486.*

Gan, G (1998). "A parametric study of Trombe walls for passive cooling of buildings." *Energy and Buildings.*

Garcia-Hansen, V, Esteves, A, and A Pattini (2002). "Passive solar systems for heating, daylighting and ventilation for rooms without an equator-facing facade." *Renewable Energy, 26(1):91-111.*

Garde-Bentaleb, F, et al (2002). "Bringing scientific knowledge from research to the professional fields: the case of the thermal and airflow design of buildings in tropical climates." *Energy and Buildings, 34(5):511-521.*

Gosselin, JR (2005). *IEA-ECBCS Annex 44, Subtask A contribution to the state of the art report.*

Gratia, E and A de Herde (2004a). "Natural cooling strategies efficiency in an office building with a double-skin facade." *Energy and Buildings, 36(11):1139-1152.*

Gratia, E and A de Herde (2004b). "Natural ventilation in a double-skin facade." *Energy and Buildings, 36(2):137-146.*

Gratia, E and A de Herde (2004c). "Optimal operation of a south double-skin facade." *Energy and Buildings, 36(1):41-60.*

Grimme, FW a L, M (1999). "Energy Efficiency in Tropical Office Buildings. Latest Developments in Daylight Guidance Systems. Modern Glazings - Efficient for Cooling and Daylighting. Development of Energy Efficiency Policy for Buildings and Research Activities after 1970 in the field of Low Energy." *Conferencia Internacional de Energía Renovable y Educación Energética, Havana, Cuba.*

Haase, M, Wong, F and A Amato (2004). "Double-skin facades for Hong Kong." *International Conference on Building Envelope Systems & Technology. Sydney, Australia.*

Haase, M, and A Amato (2005a). "Double-skin facades in Hong Kong." *5th International Postgraduate Research Conference, Salford, U.K.*

Haase, M, and A Amato (2005b). "Fundamentals for climate responsive envelopes". *Glass in Buildings 2, Bath, UK.*

Haase, M (2005c). *IEA-ECBCS Annex 44, Subtask A contribution to the state of the art report.*

Haddad, Kamel H and AH Elmahdy (1998). "Comparison of the monthly thermal performance of a conventional window and a supply-air window." *ASHRAE Transactions: Symposia. SF-98-13-3.*

- Haddad, KH and AH Elmahdy (1999). "Comparison of the thermal performance of an exhaust-air window and a supply-air window." *ASHRAE Transactions*. Vol. 105, Part 2. SE-99-12-4.
- Harris, CM (1991). *Handbook of Acoustical Measurements and Noise Control*. McGraw-Hill, New York.
- Hensen, J, Bartak, M, and F Drkal (2002). "Modelling and simulation of a double-skin facade system / Discussion." *ASHRAE Transactions*. 108:1251.
- Hensen, JLM (1993). "Towards an integral approach of building and HVAC system." *Energy and Buildings*. 19(4):297-302.
- Hensen, JLM and N Nakahara (2001). "Energy and building performance simulation: current state and future issues." *Energy and Buildings*, 33(4):vii-ix.
- Holmes, MJ (1994). "Optimization of the thermal performance of mechanically and naturally ventilated glazed facades". *Renewable Energy*. 5:1091-1098.
- Hopkinson, RG (1966). *Daylighting*. Heinemann, London.
- IEA, EAH (2002). "HybVent - Hybrid ventilation."
- <http://hybvent.civil.auc.dk/>
- IEA-ECBCS Annex 44, (2004), 2nd Annex preparation workshop, Trondheim.
- IESNA. (1999). *Recommended practice of daylighting*, Illuminating Engineering Society of North America, New York .
- Inger, A (2005). IEA-ECBCS Annex 44, Subtask A contribution to the state of the art report.
- Inoue, T, et al (1985). "Study on the thermal performance of ventilation window." *International Symposium on Thermal Application of Solar Energy*. 221-226.
- Jiru, TE and F Haghghat (2005) "Airflow and thermal modeling of DSF." IEA-ECBCS Annex 44, Subtask A contribution to the state of the art report.
- Jones, J, Messadi, T and L Shang-Shiou (1999). "Experimental study of the cooling season performance of ventilated double-glass envelope cavities." *Int Building Physics Conference*.
- Kalyanova, O, Poizaris, H and P Heiselberg (2005). IEA-ECBCS Annex 44, Subtask A contribution to the state of the art report.
- Karsai, P (1997). "Façade procurement - the role of the façade consultant." *International Conference on Building Envelope Systems and Technology*. Ottawa, Canada, 167-172.
- Kautsch, P, et al (2002). "Thermisch-hygrisches Verhalten von GlasDoppelFassaden unter

- solarer Einwirkung." 36/2002, Bundesministerium fuer Verkehr, Inovation und Technologie, Graz.
- Kleiven, T and Aschehough (2005). "Double facades at high latitudes. User experiences from Hamar Town hall." SINTEF report STF50 A05030, Trondheim, Norway.
- Kopstad, S and O-J Engelstad (2001). "Double facades in Norway – use and future potential." Student project at the Norwegian University of Science and Technology, Department of Civil and Transport Engineering, Trondheim, Norway.
- Lam, JC and DHW Li (1998). "Daylighting and energy analysis for air-conditioned office buildings." *Energy*, 23(2):79-89.
- Lam, JC and DHW Li (1999). "An analysis of daylighting and solar heat for cooling-dominated office buildings." *Solar Energy*, 65(4):251-262.
- Leal, V, et al (2003). "Modeling a reversible ventilated window for simulation within ESP-R – the SOLVENT case." *Proceedings from Building Simulation 2003*.
- Leal, V, et al (2004). "An analytical model for the airflow in a ventilated window with known surface temperatures." *Proceedings from Roomvent 2004*.
- Lee, E, et al (2002). "High-performance commercial building façades." Lawrence Berkeley National Laboratory, Un of California, Berkeley. LBNL-50502. (<http://gaia.lbl.gov/hpbf/main.html>)
- Li, DHW and JC Lam (2001). "Evaluation of lighting performance in office buildings with daylighting controls." *Energy and Buildings*, 33(8):793-803.
- Loncour, X, et al (2003). "Ventilated double facades. Evaluation of the existing standards/requirements applying on buildings equipped with ventilated double facades-overview of the existing documents and potential problems."
- Loncour, X, Flamant, G and P Wouters (2004a). "Les doubles façades ventilées."
- Loncour, X, et al (2004b). "Ventilated double facades." <http://www.bbri.be/activefacades/new/download/Ventilated%20Doubles%20Facades%20-%20Classification%20&%20illustrations.dvf2%20-%20final.pdf>
- Magali, B and E Gratia (2002). "Ventilated double facades Project. Maintenance and durability of ventilated double facades." *Un Catholique de Louvain (UCL)*.
- Manz, H (2003). "Numerical simulation of heat transfer by natural convection in cavities of facade elements." *Energy and Buildings*, 35(3):305-311.
- Marques da Silva, F and MG Gomes (2005). "Effects of different multi-storey double skin façade configurations on surface pressures." *CISBAT 2005, Lausanne, Switzerland*.
- Martin, Y and X Loncour (2004). "Les doubles façades ventilées. Exigences en matière de sécurité incendie." *CSTB*. (<http://www.bbri.be/activefacades/>)

- McEvoy, ME and SG Southall (2000). "Validation of a computational fluid dynamics simulation of a supply air 'ventilated' window." CISBE Conference, Dublin, Ireland.
- McEvoy, ME, et al (2003). "Test cell evaluation of supply air windows to characterize their optimum performance and its verification by these modeling techniques." *Energy and Buildings*, 35(2003):1009-1020.
- Mei, L, et al (2003). "Thermal modelling of a building with an integrated ventilated PV façade." *Energy and Buildings*, 35:605-617.
- Morbiter, CA (2003). "Towards the Integration of Simulation into the Building Design Process." PhD, University of Strathclyde, Glasgow.
- Müller, H (1983). "Exhaust-air ventilated windows in office buildings." *Proceedings of the 18th Intersociety Energy Conversion Conference*, 5:2015-2018.
- Oesterle, E, et al (2001). *Double-skin facades: integrated planning : building physics, construction, aerophysics, air-conditioning, economic viability*. Prestel, Munich.
- Onur, N, et al. "An experimental study on air window collector having a vertical blind for active solar heating." *Solar Energy*, 57(5):375-380.
- OPETS (1994). *Daylighting in buildings*. UCD-OPET, Dublin.
- Park, C-S (2003). "Occupant-Responsive optimal control of smart facade systems." PhD thesis, Georgia Institute of Technology, Georgia.
- Park, C-S, et al (2004a). "Real-time optimization of a double-skin façade based on lumped modelling and occupant preference." *Building and Environment*, 39:939-948.
- Park, C-S, et al (2004b). "Calibration of a lumped simulation for double-skin façade systems." *Building and Environment*, 36:1117-1130.
- Parkin, S (2003). "Development of a contemporary classification for ventilated double-skin façades." *PLEA-20th Conference on Passive and Low Energy Architecture*, Santiago, Chile.
- Parkin, S (2004). "A description of a ventilated double-skin façade classification." *International Conference on Building Envelope Systems & Technology*, Sydney, Australia.
- Parmentier, B (2002). "Les doubles façades ventilées. Aspects relatifs à la stabilité et à la sécurité." CSTB. (<http://www.bbri.be/activefacades/>)
- Pasquay, T (2004). "Natural ventilation in high-rise buildings with double facades, saving or waste of energy." *Energy and Buildings*, 36(4):381-389.
- Perino, M (2005). *IEA-ECBCS Annex 44, Subtask A contribution to the state of the art report*.

- Poirazis, H (2004). "Double-skin facades for office buildings." EBD-R-04/3, Division of Energy and Building Design, Dept of Construction and Architecture, Lund Inst of Tech, Lund Univ, Lund.
- Prianto, E, and P Depecker (2002). "Characteristic of airflow as the effect of balcony, opening design and internal division on indoor velocity - A case study of traditional dwelling in urban living quarter in tropical humid region." *Energy and Buildings*, 34(4):401-409.
- Reichrath, S, and TW Davies (2002). "Using CFD to model the internal climate of greenhouses: past, present and future." *Agronomie*, 22(1):3-19.
- Saelens, D, Carmeliet, J and H Hens (2003). "Energy performance assessment of multiple skin facades." *Intl Journal of HVAC&Research*, 9(2):167-186.
- Shang-Shiou, L (2001). "A protocol to determine the performance of South facing double glass façade system." MSc Thesis in Architecture, Virginia Polytechnic Institute, Blacksburg, VA, USA.
(<http://scholar.lib.vt.edu/theses/available/etd-04212001-152253/unrescrtited/>)
- Sodergren, D and T Bostrom (1971). "Ventilating with the exhaust-air window." *ASHRAE Journal*, April, 51-57.
- Southall, RG and M McEvoy (2000). "Results from a validated CFD simulation of a supply air 'ventilated' window." *Proceedings from Roomvent 2000*.
- Stec, W and AHC van Paassen (2001). "Controlled double facades and HVAC." 7th Clima 2000 World Congress, Napoli (I).
- Stec, W and AHC van Paassen (2002). "Validation of the simulation models of double skin facade." *ABT2002, Hog Kong*.
- Stec W and AHC van Paassen (2003). "Defining the performance of the double skin façade with the use of the simulation model." *Proceedings of the 8th International IBPSA Conference Building Simulation 2003, Eindhoven, The Netherlands*.
(http://www.ocp.tudelft.nl/et/Research/EnergyInBuiltEnvironment/SecondSkinFacade/DSF/publications/p492final_v2.pdf)
- Stec, WJ and AHC Paassen (2004). "Symbiosis of the double skin facade with the HVAC system." *Energy and Buildings*, In Press, Corrected Proof.
- Szokolay, SV (1980). *Environmental science handbook for architects and builders*. Construction Press, Lancaster.
- Takahashi, Y (2005). *IEA-ECBCS Annex 44, Subtask A contribution to the state of the art report*.
- Takemasa, Y, et al (2004). "Performance of hybrid ventilation system using DSF and vertical airshaft." (http://kajima.co.jp/tech/katri/technical/annualj/vol_52/pdf/52-33.pdf)

- Tanimoto, J and K Kimura (1997). "Simulation study on an airflow window system with an integrated roll screen." *Energy and Buildings*, 26:317-325.
- Tjelflaat, PO and B Bergesen (1985). "Improved thermal insulation in windows by laminar airflows." *ASHRAE/DOE/BTECC Conference: Thermal Performance of the Exterior Envelopes of Buildings III. Clearwater Beach, FL, ASHRAE SP 49.*
- Tomory, T (1983). "Extract-air window." *Proceedings of 9th CIB Congress, Stockholm, Sweden.*
- van Dijk D (2003). "WIS version 2.0.1 User Guide.
- (<http://www.windat.org>)
- van Dijk D and J Goulding (editors) (1996). *Reference Manual WIS, Advanced Windows Information System. Univ of Dublin, Ireland.* (http://windat.ucd.ie/wis/html/wis201/docs/WIS_ref_manual_10.pdf)
- van Paassen AHC and W Stec (2001). "Controlled double facades and HVAC." *Proceedings of the 7th Clima 2000 World Congress, Napoli, Italy.*
- van Paassen AHC and M van der Voorden (2000). "Development of simplified tools for evaluation energy performance of double façades." *Proceedings of the International Building Physics Conference, Eindhoven, Netherlands.*
- von Grabe, J (2002). "A prediction tool for the temperature field of double facades." *Energy and Buildings*, 34(9):891-899.
- Watson, DE (1993). *The Energy Design Handbook. American Institute of Architects Press, Washington, DC, USA.*
- Welleershoff, F and M Hortmanns (1999). "Wind loads on double façade systems with gaps greater than 15 cm." *10th ICWE, Copenhagen, Denmark.*
- Wigginton, M and J Harris (2002). *Intelligent Skins. Butterworth-Heinemann, Oxford.*
- Wright, JL (1986). "Effective U-values and shading coefficients of preheat/supply air glazing systems." *Proceedings of Renewable Energy Conference '86, Solar Energy Society of Canada, Ottawa, Canada.*
- Xu, W and Q Chen (2001a). "A two-layer turbulence model for simulating indoor airflow: Part I. Model development." *Energy and Buildings*, 33(6):613-625.
- Xu, W and Q Chen (2001b). "A two-layer turbulence model for simulating indoor airflow: Part II. Applications." *Energy and Buildings*, 33(6):627-639.
- Yuill, GK (1987). "Laminar air flow super window." *Prepared for Renewable Energy Branch, Energy Mines and Resources, Ottawa, Canada, File No 6179, DD#71.*
- Zhai, Z, et al (2002). "On approaches to couple energy simulation and computational fluid

- dynamics programs." Building and Environment, 37(8-9):857-864.*
- Zhai, Z and QY Chen (2003). "Solution characters of iterative coupling between energy simulation and CFD programs." Energy and Buildings, 35(5):493-505.*
- Zhai, Z and QY Chen. "Numerical determination and treatment of convective heat transfer coefficient in the coupled building energy and CFD simulation." Building and Environment, In Press, Corrected Proof.*
- Zhang, W and Q Chen (2000). "Large eddy simulation of indoor airflow with a filtered dynamic subgrid scale model." International Journal of Heat and Mass Transfer, 43(17):3219-3231.*

Chapter 3 Thermal Mass activation (TMA)

3.1 Thermo Active Building Systems (TABS)

3.1.1 Component description

Thermal mass activation is a relatively new approach to radiant heating/cooling of the buildings. In 1937, the first construction, called “Crittall”, was installed, in Switzerland. The system with embedded steel welded pipes in a concrete slab provided radiant heating and cooling (Deecke 2003). Radiant heating installations can also be easily converted into radiant cooling installations by running cold water through the radiant panels. Most of the early cooling ceiling systems developed in the 1930s failed, because the condensation often occurred during operation in cooling mode. Subsequent studies showed that this problem could be avoided if the radiant system was used in conjunction with a small ventilation system designed to lower the dew point of the indoor air. This combination proved successful in a department store built in 1936-1937 in Zurich (Giesecke 1946), and in a multi-story building built in the early 1950s in Canada (Manley 1954).

Active building components are thermally heavy parts of the building construction (walls, ceilings, floors or in floors between storeys in multi-storey buildings), which are equipped with ducts for circulation of air or embedded pipes for circulation of water. Components with embedded pipes in floors in multi-storey buildings are mostly used today. This trend started in the beginning of nineties in Switzerland (Meierhans 1993 and 1996). It uses thermal storage capacity of the concrete slabs between each storey of the building. Pipes carrying water for heating and cooling are embedded in the centre of the concrete slab (Figures 1.1a and 1.2). Circulation of the water activates the thermal mass of the slab, which has not only a direct heating-cooling effect, but also reduces the peak load and transfer some of the load to outside the period of occupancy. Because these systems for cooling operate at water temperature close to room temperature, they increase the efficiency of heat pumps, ground heat exchangers and other systems using renewable energy sources.

3.1.1.1. Description of the component types

3.1.1.1.1 Airborne systems

The cavities are used to circulate air through the concrete slabs Figure 3.1a. This way concrete mass is heated or cooled. The system has been used mainly in office buildings in the 1980's, but nowadays we cannot find many buildings using it. The circulated air can be also used as supply air to the premises. The decks are constructed to ensure large heat exchange surface between the air stream and the concrete. The cavities also allow the air to get through the whole floor construction.

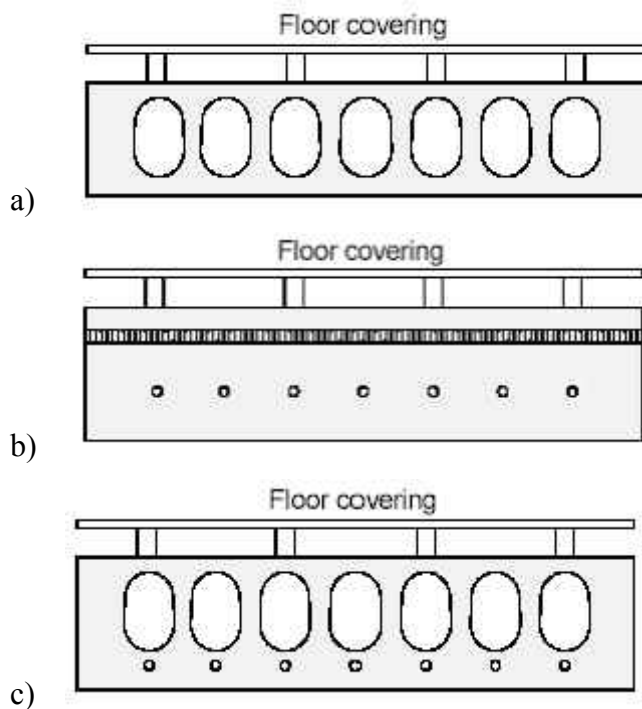

Figure 3.1. – Basic types of currently used thermo active building components (Wietzmann 2002): a) hollow deck with cavities for air circulation; b) on-site constructed floor (with insulation); c) hollow deck with integrated pipes (hollow can be also filled up with polystyrene or other light materials)

3.1.1.1.2 Water based systems

Water based thermo active components are typically used in buildings in Central Europe (Figure 3.1.1b). Pipes are commonly installed in the centre of concrete slab between the reinforcements. Usual diameter of the pipes varies between 17 and 20 mm. The distance between pipes is within the range 150 - 200 mm. Figure 3.2(left) shows cross-section of commercially available system.

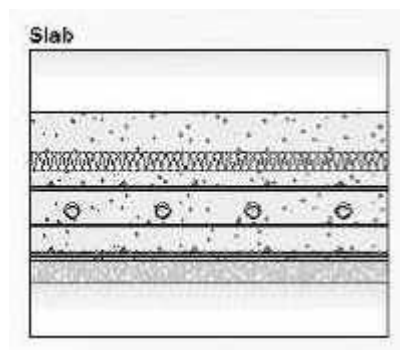
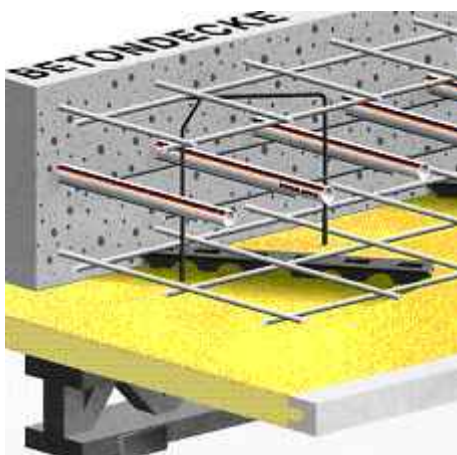

Figure 3.2. – Left: cross-section of the on-site constructed system (www.velta.de); right: example of positioning the pipes in the building construction (Olesen 2000)

If the system is constructed on site, the pipes are supplied in modules, which include a pipe coil attached on the metal grid and equipped with fittings (Figure 3.3). A layer of insulation to direct the heat flows downwards and prevent noise distribution can be installed between the concrete slab and the floor surface (Figure 3.2(right)). If no prefabricated modules are used or building shape is more complicated, pipes can be manually attached to the reinforcement. The reinforcement grid with the pipes is then covered by concrete mass (Figure 3.4).

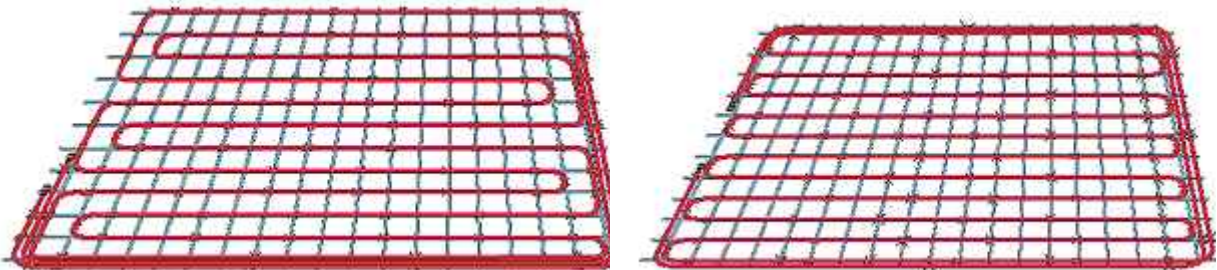

Figure 3.3 – The Pipe modules supplied to be embedded in concrete slab on-site (www.rehau.de)

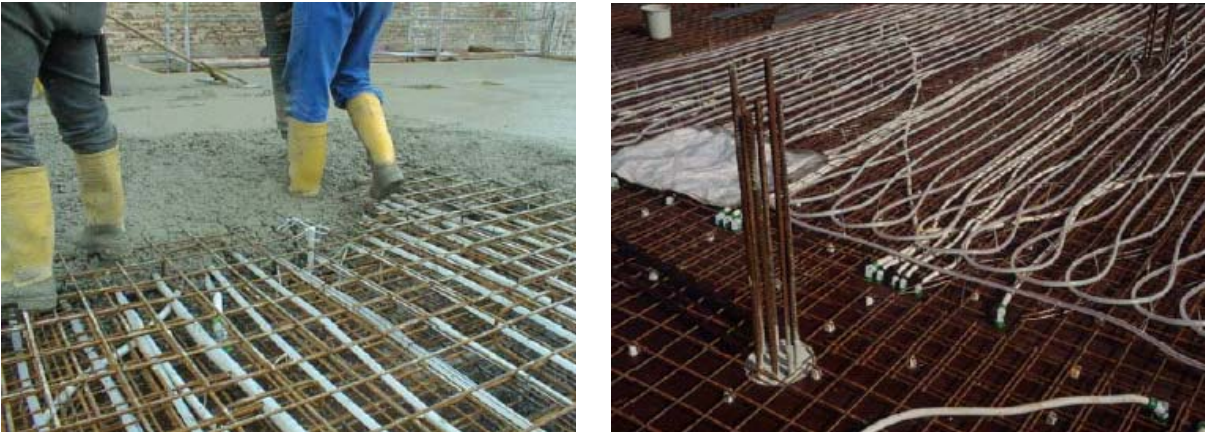

Figure 3.4 – Concrete lying on the reinforcement grid with attached pipes (Hauser 2005)

3.1.1.1.3 Other types of components

In some cases, also walls of the building are thermally activated (Figure 3.5).

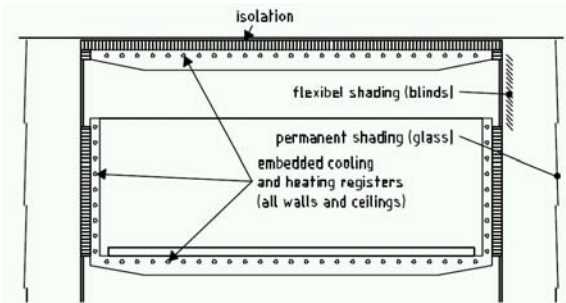

Figure 3.5 – Cross section of the building with activated concrete slabs and walls (Meierhans and Olesen 2002)

Component is particularly suitable for multi storey buildings and is commercially available .

3.1.2. Example of existing applications

3.1.2.1 The Centre for Sustainable Building (ZUB)

Location: Kassel, Germany



Figure 3.6 – The Centre for Sustainable Building (ZUB) in Kassel, Germany (De Carli et al. 2003)

The office building belongs to the Centre of Sustainable Building (ZUB), University of Kassel, Germany. The building is an example of new low temperature heating/cooling systems implementation. The ZUB office building consists mainly of three different parts: one part for exhibitions and events, one part for offices and an experimental part for different kinds of research in innovative building technologies and building services concepts. The load bearing skeleton in reinforced concrete consists of round pillars with a distance of 5.40 m and flat concrete slabs for the floor/ceiling construction.

A water-based conditioning system with embedded pipes is used for heating and cooling of the offices. In the case of heating operation mode, the system works with water inlet temperatures controlled according to the outdoor temperatures (approx. 24° C). In case of cooling need, pipes embedded in the floor slab of the basement are used as a ground heat exchanger. Mechanical cooling is not required. Figure 3.7 shows the positions of the different cooling/heating systems installed in the building.



Figure 3.7 – Different positions of pipes as used in the ZUB in building Kassel, Germany (De Carli et al 2003)

There are two layers of the pipes in the floor constructions of the building. As shown in Figure 3.7, the pipes are embedded in the concrete slabs and in the upper floor construction (regular floor heating/cooling). This design was used to be able to test the properties of different systems and their advantages. Pipes are made in polyethylene with a diameter of 20 mm and a distance of 150 mm. In the basement, the pipes have a diameter of 25 mm. The distribution of the pipes in the slab has a coil shape. Each circuit of the floor radiant system and the active thermal slab system is supplied by approx. 600 kg/h water mass flow rate. The difference between supply and return water temperature is lower than 4-5 °C. Individual regulation of the thermal conditions in each room is possible because each room has its own heating/cooling circuit.

3.1.2.2. Office building of Bertelsmann C. Verlag GmbH

Location: Munich, Germany

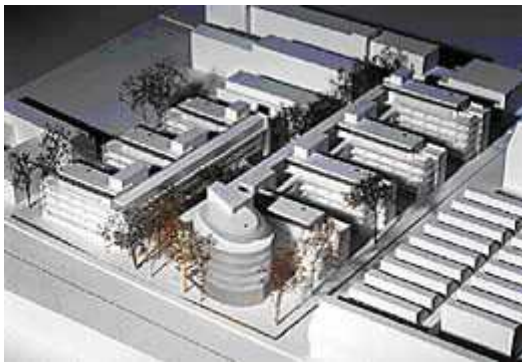

Figure 3.8 - Office building of Bertelsmann C. Verlag GmbH, Munich, Germany (www.velta.de)

The four-story building consists of two main long parallel buildings, each with additional building wings. The building has offices facing all directions. The slab heating and cooling system is used. It is combined with a mechanical ventilation system and radiators as an additional heating system (Figure 3.9). Offices are also equipped with open able windows. In the spaces with higher internal loads (conference rooms), a suspended cooled ceiling was installed. The building is divided in four zones with separate supply-return pipes and control, so they independently could be cooled or heated. The design water temperatures were for cooling 16 °C supply/19 °C return and 24 °C supply/22 °C return for heating. The supply temperature is controlled separately for each zone according to an average zone temperature based on several room temperature sensors.

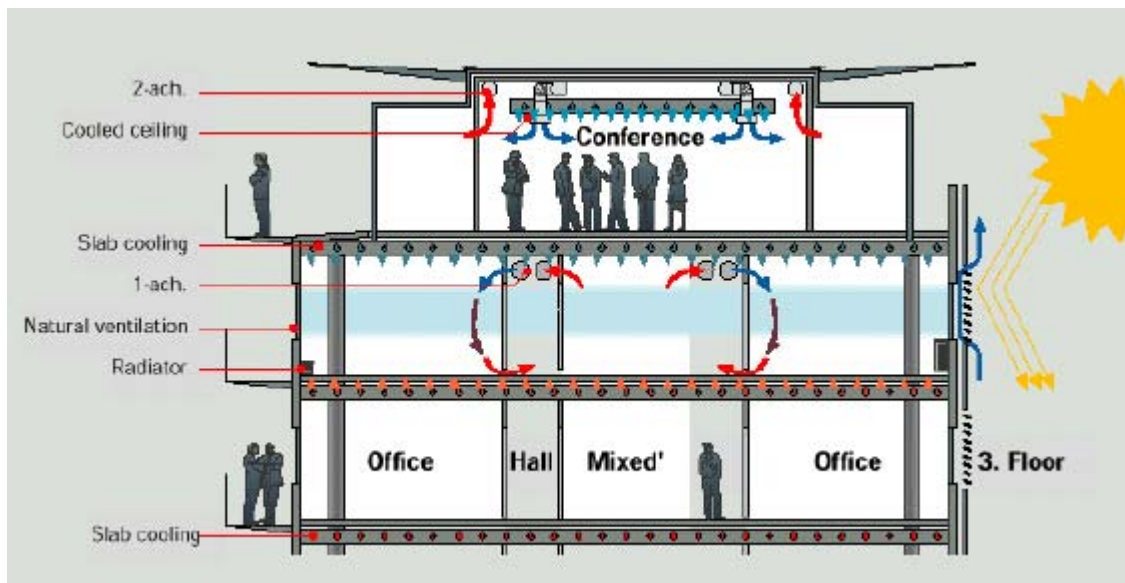

Figure 3.9 – Office building in Munich, installation of activated thermal mass components (Olesen 2000)

3.1.2.3 Berliner Bogen

Location: Hamburg, Germany

The construction of a new office block in Hamburg was finished in December 2001. The modern conception with the glass facades in the outer shell is used. A heating/cooling system is 18,000 m² of activated thermal slabs between the storeys of the building. The pipe work system comprises of the prefabricated pipe matrices (modules). Each module included a coil of 20 x 2,3 mm pipe. Water supply temperature ranges between 16 and 20 °C during the cooling mode and between 22 - 28°C in heating mode.



Figure 3.10 – Berliner Bogen: example of the building construction – double skin facade and floor slabs (left) where activating system of pipes was embedded (right) (www.velta.de)

3.1.3. Working principles

Technologically, the design of thermo active components is based on the characteristics of other radiant systems: distance, diameter of pipes, thickness of the concrete layer, position of the pipes inside the concrete, supply water temperature and water mass flow rate.

Besides the direct cooling and/or heating capacity, the TABS have also the thermal storage effect. The heat can be stored in the concrete slab. This effect has its dynamics, which is difficult to calculate using steady state assumptions and computer simulation is often required. The effect of TABS is demonstrated in Figure 3.11. It shows the results from a simple simulation program (Meierhans and Olesen, 1999). The Figure 3.11a shows the temperature variation over 24 hours for a space exposed to an internal load and without any cooling. At the initial state 6:00 o'clock in the morning, all surface temperatures are 20°C. When the internal load is introduced, the room temperatures start to rise immediately. The operative temperature keeps increasing the whole day to approximately 26°C at 18:00 o'clock, when the internal load declines. During the night, (no internal loads) the space cools down and reaches by the next morning an operative and average slab temperature of 21.3°C, which is 1.3 K higher than the day before. Each day the temperatures will then increase progressively. If the core of the concrete slab is constantly kept at 20°C (Figure 3.11b), next morning, all the temperatures will decrease to the same level as the day before. During the day the average slab temperature increases to 21.5°C, but it is decreased again during the night. The Figure 3.11c shows the temperatures in case that the core is only cooled to 20°C outside of the building occupation period (night). It can be seen from the Figure that the results are almost the same as for the 24 hours cooling. The operative temperature is only

slightly higher. During the period when the core is kept at 20°C, the temperature difference between core and average slab is higher and this causes an increased energy transport. Therefore, even if the shorter cooling time, the total cooling effect is about the same. This is one of the benefits of using TABS, the peak load during the day will be stored and removed by cooling during the night.

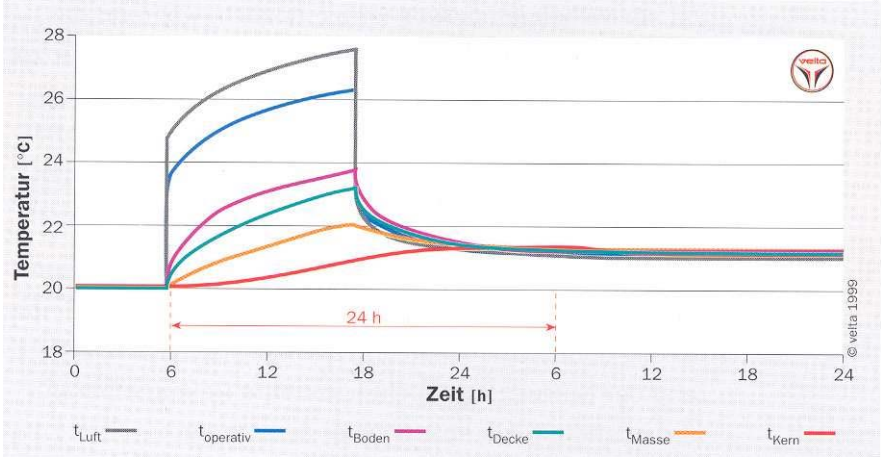

a)

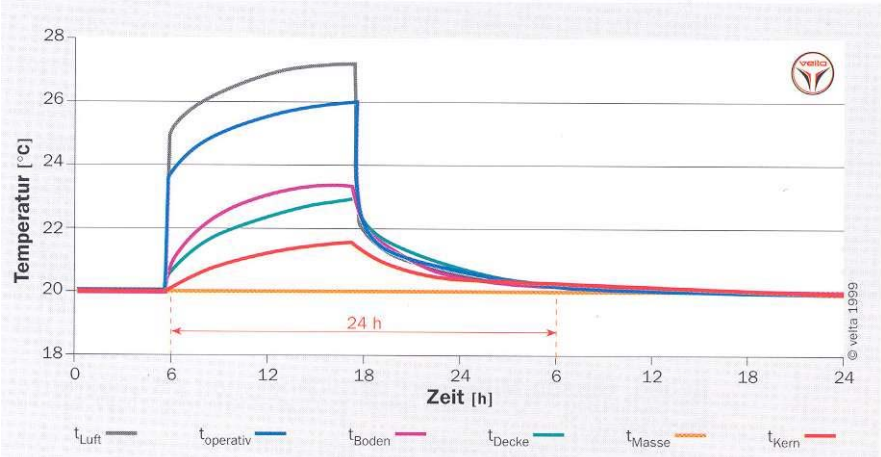

b)

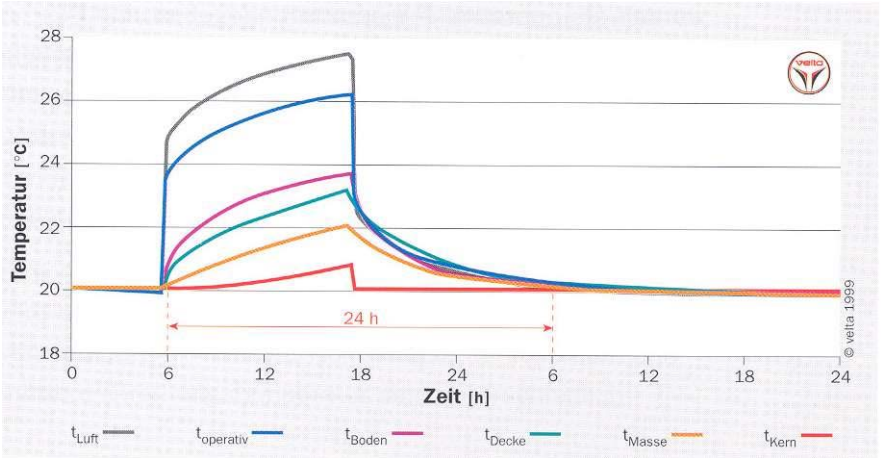

c)

Figure 3.11 – Calculated air, operative, floor, ceiling, average slab- and slab core temperatures for a space with a constant internal load of 90 W/m² from persons, light, sun etc. (Meierhans and Olesen 1999).

3.1.3.1. Heat transfer between room and thermo active component

Three physical mechanisms of heat transfer take place in the space heated/cooled by activated thermal slab system:

- Conduction
- Convection
- Radiation

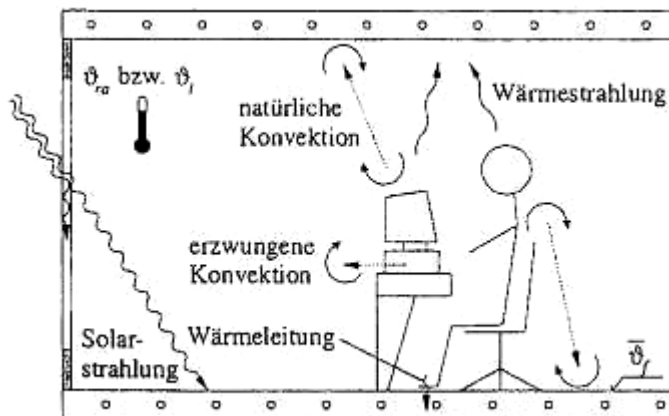

Figure 3.12 Thermal balance model of a room equipped with radiant heating/cooling

(Koschenz et al. 2000)

Thermo active components have a large radiant part in the heat transfer between heated/cooled surface and room, which can be seen by comparing the radiant and convective transfer coefficients. The coefficients depend on the position of surface (wall, ceiling, floor), the operation mode (heating/cooling) and on the temperature difference between heated/cooled surface and space. For radiation, the value of heat transfer coefficient is approximately 5.5W/m²K in rooms under “normal” cooling conditions, while the convective coefficient is between 3 and 5.5W/m²K. Influence of both convection and radiation can be expressed by means of combined heat transfer coefficient. The approach to calculation of a combined heat transfer coefficient will be the part the new European standard prepared in TC 228: prEN 15377 – 2.

Table 3.1 shows combined heat transfer coefficients for different types of radiant heating. In addition, acceptable surface temperatures and maximum heating/cooling capacities for different systems are listed. It should be pointed out, that ceiling heating/cooling mentioned in the table does not refer to use of activated thermal slab of the ceiling, but common radiant system with pipes close to the ceiling surface, so the heating/cooling capacities listed are higher than those which can be expected in case of using thermal activation.

Table 3.1 – Total heat exchange coefficient (convection + radiation) between surface and space for heating and cooling, acceptable surface temperatures and capacity by 20 °C room temperature for heating and 26 °C room temperature for cooling (Olesen et. al. 2000)

		Total heat exchange coefficient W/m ² K		Acceptable surface temperature °C		Maximum capacity W/m ²	
		Heating	Cooling	Max. Heating	Min. Cooling	Heating	Cooling
Floor	Perimeter	11	7	35	20	165	42
	Occupied Zone	11	7	29	20	99	42
Wall		8	8	~40	17	160	72
Ceiling		6	11	~27	17	42	99

The larger part of the heat transfer from the rooms above and below the concrete deck to its core will, for cooling, be through the ceiling surface. The distribution is found to be 2/3 through the ceiling and 1/3 through the floor (Koschenz and Lehmann 2000). Another report (Hansen et al. 2002) showed that 85% of the heat transfer is through the ceiling surface. As it can be seen, the actual distribution depends greatly on the actual configuration of the deck construction with respect to floor covering and i.e. acoustic ceilings.

3.1.3.2. Control and operation

The response time of the system is rather long due to its high thermal mass. Therefore, an individual room control is not reasonable, but a zone control (south – north); where the supply water temperature, average water temperature or the flow rate may differ from zone to zone, is often suitable solution. The zoning considers the external and/or internal heat loads.

Small difference between heated/cooled surfaces (supply water) and the ambient temperature results in a significant degree of self-control effect, because a small change in this temperature difference will influence the heat transfer between the cooled/heated surface and the space significantly. In specific cases, (well-designed systems in buildings with low heating/cooling loads) a concrete slab can be controlled at a constant core (water) temperature all year round. If, for example, the core is kept at 22 °C, the system will provide heating at room temperatures below 22 °C and cooling at room temperatures above 22 °C.

In order to avoid condensation, the water temperature or the surface temperature and the absolute humidity should be controlled (surface temperature should be maintained above the dew-point of the ambient air for all operational conditions). A control strategy to reduce the risk of damage due to condensation is that mean supply water temperature is controlled depending on the dew point temperature (absolute humidity). Another solution can be installation of dehumidification in a ventilation system. Then the humidity sensor is placed in the exhaust duct. If the dew point is further reduced through dehumidification of the supply air, the temperature of the radiant surface can also be reduced, and higher sensible loads can be removed by radiation. However, increased performance of the system means also increase in its costs.

Following strategies are usually applied for control of the water temperature:

- Mean water temperature as a function of outdoor temperature
- Supply water temperature as a function of outdoor temperature
- Mean water temperature kept constant
- Supply water temperature as a function of dew point temperature

3.1.3.3. The influence of the concrete mass

Thermal mass of the activated concrete slabs, or more precisely, its high heat capacity plays a significant role for the thermodynamic properties of the heating/cooling system and hence for the control strategy. The effect of a stepwise varying water inlet temperature (T_W) in the floor pipes on the floor temperature is qualitatively shown in Figure 3.13left. The actual floor temperature (T_F) asymptotically approaches the stationary floor temperature T_C . When the temperature difference between two stationary floor temperatures is given by ΔT_F , then the parameter t is the response time of the floor mass, in which T_F changes by:

$$\Delta T_F \cdot \frac{(e-1)}{e}.$$

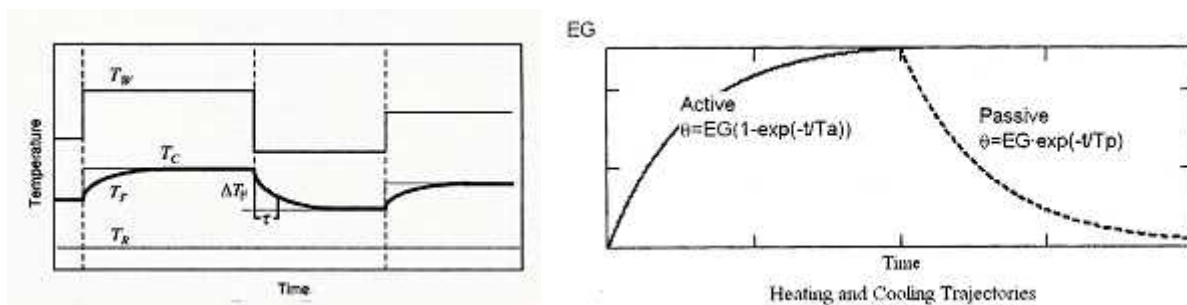

Figure 3.13 – left: The effect of stepwise varying water temperature T_W on the floor temperature T_F : asymptotically approaches the stationary floor temperature T_C . The symbol τ is the response time of the floor mass (Rekstad et al. 2003); right: The typical heating and cooling trajectories (Chapman et al. 2004)

The Figure 3.13 right shows increase of the air temperature as a function of time from the start of heating of occupied space (solid line). The dashed line represents the case when heat supply is turned off and thermal mass slowly cools down. T_a and T_p are the time constants in heating mode and off heating mode.

Applicable control strategies for the heating/cooling water flow rate – circulation pump operation are described in the Table 3.2.

Table 3.2 – Control strategies for thermal mass activation systems

Control strategy	Pump operation	Description
Modulated, continuous heat supply	- 24 hour operation - 12 hour night operation - 8 hour night operation	For continuous heat carrier circulation, the heating power delivered to the room can be expressed as a linear function of the temperature difference between heat carrier and a room temperature ($T_w - T_R$). The control of the air temperature in the room can be achieved by adjusting T_w according to the instant power demand.
Discontinuous heat supply	- 15 min ON/ 45 min OFF (25% duty cycle ^(*)) - 1 h ON/ 1 h OFF (50% duty cycle) - 0,5 h ON/ 0,5 h OFF (50% duty cycle)	The long response time justify the substitution of power control with energy control in terms of intermittent heat supply. The heat supply is then restricted to a characteristic time interval Δt , which fulfils the requirement $\Delta T < 1$ K in order to avoid undesirable temperature fluctuations.

^(*)The duty cycle (d) is the fraction of time within certain time interval, when the water circulates in the floor pipes ($0 < d < 1$) (0-100%).

Figure 3.14 shows that appropriate control strategy may lead to cuts of peak power demand. While the intermittent daytime operation or the night storing/daytime releasing of energy is used we save energy.

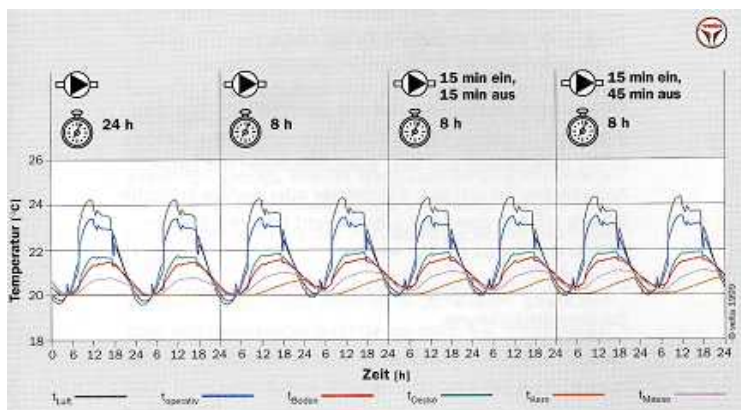

Figure 3.14 – Room temperature profile of room evaluated by the dynamic simulation program with regards to various operation modes (Meierhans and Olesen 1999)

3.1.3.4. Economical aspects of the operation

From the economical point of view, we consider two optimal control and operation strategies:

- Minimum total energy costs
- Minimum peak electrical demand

3.1.3.5 Capacity evaluation

Using systems with activated thermal mass is recommended for buildings with the heat/cooling loads up to 50 W/m^2 . The heat transfer between the embedded pipes and the surface of the wall, ceiling or floor will as long as there is no airspace in the construction, follow the same physics. It is then possible to use the standard for floor heating (EN1264, 1998), but this can be applied only for the calculations of steady state operating conditions and this is not sufficient for the design of the system utilizing high thermal mass. Prediction of the dynamic behavior of the system is possible by using computer simulation based on Finite Elements Method (FEM) or Finite Difference Method (FDM) (will be included in new CEN standard prEN 15377). The design and calculation of the direct heating and cooling capacity depends mainly on distance between pipes, thickness of the concrete slab above/below pipes, surface material and water temperature.

3.1.4. Application field

Activation of the thermal mass has two main effects on whole building operation and indoor environment. The first one is direct cooling/heating effect; main part of the heat exchange is realized by radiation. The second effect is a peak load reduction, due to the absorption of the heat by massive concrete construction. Some of the load is therefore transferred outside the period of occupancy.

During both heating and cooling mode, system is operating with the temperatures close to room temperature; this gives an opportunity to use renewable energy sources (heat pumps, ground heat exchangers etc.). It also means a high level of “self control” – small change in the temperature difference between cooled or heated surface and the space will significantly influence the actual heat transfer.

3.1.4.1. Climate context

The most of the component applications can be observed in moderate climatic zones. Installations in cold climatic zones are limited mainly by heating capacity of the system. Using the systems in tropics has the other limitations. As mentioned in Chapter 2, the temperature of the activated slab must be higher than the dew point of the air in the space to avoid condensation. This means that in the climatic zones where high relative humidity occurs system must be combined with mechanical ventilation equipped by dehumidification.

3.1.4.2. Location of the element

TABS belong to the radiant systems, but its construction and way of operation differs from others. They are designed so that a thermal storage capacity of concrete mass of the building can be used for heating and cooling. To do this, the system of pipes carrying water or air duct system is embedded into the concrete construction. In most cases only concrete slabs between storeys are “activated” with water-based systems. In a special cases, pipes are embedded also into the wall constructions.

3.1.4.3 Ventilation of the buildings equipped by TABS

Utilization of the thermally activated components effectively reduces the size of the ventilation system. It is not designed to extract cooling loads or heat the building but only supply fresh air for the occupants. This means that much lower air change rates can be used. If slightly cooled, supply air can also provide some additional cooling, when it is needed (during peak loads during extremely hot days, installation of the system in warmer climatic zones).

3.1.4.4 Suitability for use with the other building components

Suitability of the TABS components to be used with other building components is listed in the Table 3.1.

Table 3.3 - Suitability for combined use of TABS components

Building component	Suitability for combined use	Note
Advanced facades	Yes	Very suitable combination, advanced façade systems provide solar shading to decrease solar gains in the summer and also sufficient thermal insulation during the winter, this helps keep heating/cooling demand on the low level and allows TABS to work with the highest efficiency.
Natural ventilation	Yes	Natural ventilation provides clean air into the premises without additional energy consumption (fans etc.) and gives the occupants ability to adjust their thermal environment. Self-control behaviour of the TABS is more pronounced.
Mechanical and hybrid ventilation	Yes (with limitations)	Certain limitation can be seen in the fact, that using the whole surface of ceiling for TABS does not give a space for duct installations. The ventilation system must be integrated into the walls, floor etc.
Lightning	Yes (with limitations)	Suspended ceiling cannot be used, lighting installations should be designed in different way.
Earth coupling	Yes	TABS are very suitable for utilization of low valued energy obtained from ground heat exchangers for cooling.
Phase-Change Materials	Yes	Research is still in process (EMPA, Switzerland; University of Ljubljana – Uros Stritih)
Dynamic insulation systems	Not known	
Raised floors	Yes	In the buildings where all ceiling surface is used for radiant heating/cooling usage of raised floor is sometimes only solution when a space for electrical and other installation is needed.
Suspended ceilings	No	Suspended ceilings cannot be used

Principal input parameters for the calculation to be considered :

- Operational mode (heating /cooling)
- Supply water temperature
- Temperature difference (supply-return, and thus the return water temperature)
- Upper and down room air temperature
- Relative air humidity (cooling)
- Horizontal position of pipes
- Distance between pipes
- Length of pipes
- Material and dimension of pipes
- Ceiling structure, floor structure, cover layer (physical parameters of layers)
- Combined heat transfer coefficient

Results from the calculation:

- Steady-state heating/cooling capacity through the floor and/or ceiling side of the slab
- Steady-state mean floor and/or ceiling surface temperature
- Heating/cooling water mass flow rate
- Pressure drop of the piping

The steady state heating/cooling capacity calculation is not sufficient, because the prediction of dynamic behaviour of the system with slow power dynamic is hardly complicated. This calculation can be done by software using two or three dimensional Finite Elements Method (FEM) or Finite Difference Method (FDM). FEM is a numerical computation method, which solves the boundary tasks for partial equations or differential partial equations (e.g. Thermal Conduction Equation, under The Law of Conservation of the Energy). FEM is useful for arbitrary shaped domain in 1D, 2D or 3D. The solved problem is divided in network consisting of triangles and quadrangles in 2D and from tetrahedron, blocks and prismatic elements in 3D. Thus, the graphical combination covers all domains. After creating elements (nodes, connections), the solution is than approximated by solving the boundary equations on the elements.

The use of FED is closely connected to the simple domains (entities) that can be discrete to the join of quadrangles. Instead of solving the whole domain, FED estimates the solutions only in nodes of the network. Thus the thermal simulation and the simulation of air velocity can be done. Based on the boundary condition input (thermal properties of building, proportions of rooms, occupants' behaviors, transient internal/external heat loads) the FEM based programs calculate the development of various physical parameters (e.g. the operative temperature, etc.).

3.1.6. Available experimental procedure to assess element performances

An experimental testing is not practically done and necessary in case of TABS. For testing and predicting of operational behaviour of TABS is more efficient to use mathematical models (simulations) based on FEM/FDM to evaluate performance of the planned system.

3.1.7. Availability of measured performances (labs. and field measurements)

De Carli and Olesen (2000) measured thermal environment parameters in four buildings heated or cooled by hydronic radiant systems. Buildings with the following systems were examined: (a) wall-floor-ceiling heating-cooling system (light structure building), (b) floor heating-cooling system, and, (c) active thermal slab system with pipes embedded in the deck. Results of the measurements are summarized in Table 3.4. The table shows the most frequent ranges of operative temperatures measured in the examined buildings and the most frequently observed operative temperature drifts.

Table 3.4 – Summary of the results from the field measurements by De Carli and Olesen (2001); building 1 - wall-floor-ceiling heating-cooling system (light structure building), building 2 and 3 - floor heating-cooling system and building 4 - active thermal slab system

Building (system type)	Operative temperature, t_o		Operative temperature drift	
	Most prevalent t_o range (°C)	Prevalence of the t_o range (% of time)	Most prevalent ramp (K/h)	Prevalence of the ramp (% of time)
building 1	21 – 22	26.9	0.2 – 0.3	38
	22 – 24	42.9	0.3 – 0.4	38
building 2	21 – 22	15.5	0.2 – 0.3	26
	22 – 24	46.5	0.3 – 0.4	22.5
building 3	21 – 22	19	<0.1	98.7
	22 – 24	20	0.1 – 0.2	1.3
building 4	21 – 22	12.7	0.1 – 0.2	52
	22 – 24	53.3	0.2 – 0.4	36.6

As can be seen from the table, the operative temperature in the occupied spaces varied between 21°C and 24°C during most of the working hours. This resulted in a temperature drift from 0.2 to 0.4 K/h.

Figure 3.16 presents operative temperatures measured during the heating and cooling period by De Carli (2002) in an office building situated in Stuttgart, Germany. The building was equipped with an active thermal mass heating/cooling system.

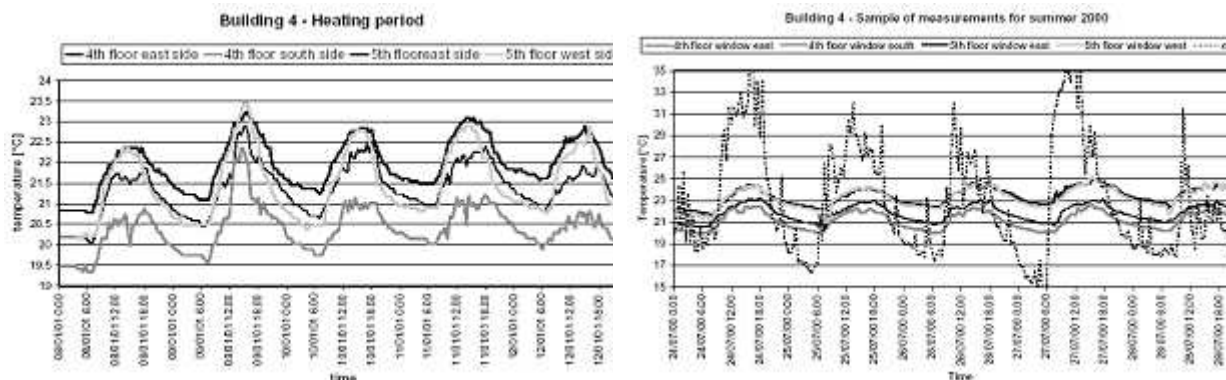

Figure 3.16 – Sample of operative temperatures measured during a working week in the heating season (left) and the summer season (right) in an office building equipped with active thermal mass heating/cooling system (De Carli 2002)

Fraunhofer Institut für Bauphysik in Germany works on the full-size house test facility (called VERU), which enables energetic and indoor climate tests to be performed under real weather conditions. Different building components can be tested under controlled conditions. The project includes also testing of thermo active components. Since the test facility is in the construction phase, no results are yet available (www.bauphysik.de/veru).

3.1.8. Availability of simulated performances

In the study by Meierhans (1993), system with embedded pipes in the slab constructions of office buildings for heating and cooling was introduced. Results in the form of simulations (compare to the measurements) were presented for an office building in Horgen, Switzerland. The results indicated that the indoor temperature was kept at an acceptable range even during very hot outdoor conditions.

Computer simulations of heating/cooling system with pipes embedded in the concrete slabs between the floors in a multi-storey building were conducted by Hauser et al. (2000). The simulated system supplied or removed the heat from the space by heated/cooled water flowing in the pipes. The results showed a significant improvement of thermal comfort by reducing the annual maximum operative temperature by 10 K (39°C - 29°C) compared to no cooling.

Brunello et al. (2001) introduced a mathematical model for simulation of thermo-active systems with activated thermal mass. The model uses suitable transfer functions to treat conduction between the water flowing through the pipes and the surroundings. The model considers transient conditions and allows analysis of the influence of different parameters such as piping pattern, thermal storage capacity, water supply temperature etc. under different climatic conditions.

Olesen and Dossi (2004) performed dynamic simulation of a room in an office building using the program TRNSYS. The ceiling/floor consisted of concrete slabs with plastic pipes embedded in the middle. Heat was supplied or removed by the heated or cooled water flowing in the pipes. The multidimensional heat transfer processes in the slab were modelled. The simulation was done for two locations of the building – Würzburg (Germany) and Venice (Italy). Different ventilation strategies; water inlet temperature control algorithms and circulation pump operation times were examined. Figure 3.17 shows energy transfer through the activated thermal slab and pump running hours for summer conditions with simple ventilation strategy. On the horizontal axis, the results for different control strategies for inlet water temperature are depicted.

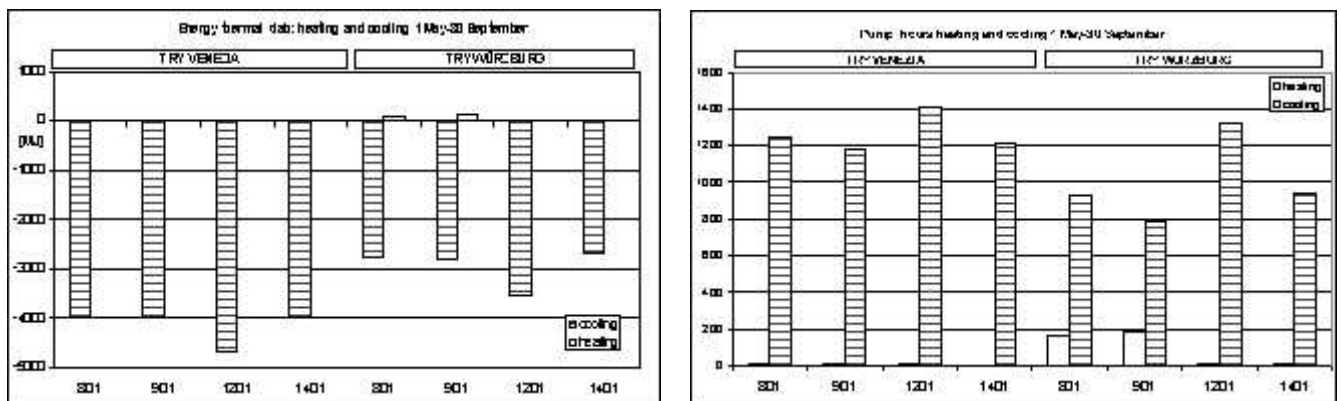

Figure 3.17 – Energy transfer and pump running time for different inlet water temperature control strategies. System dead-band: 22 – 23°C. Ventilation rate: 4.7 l/s (0.3 ach) from 17:00 to 8:00, 22 l/s (1.5 ach) from 8:00 to 17:00, summer conditions; (figures based on the data from Olesen and Dossi 2004)

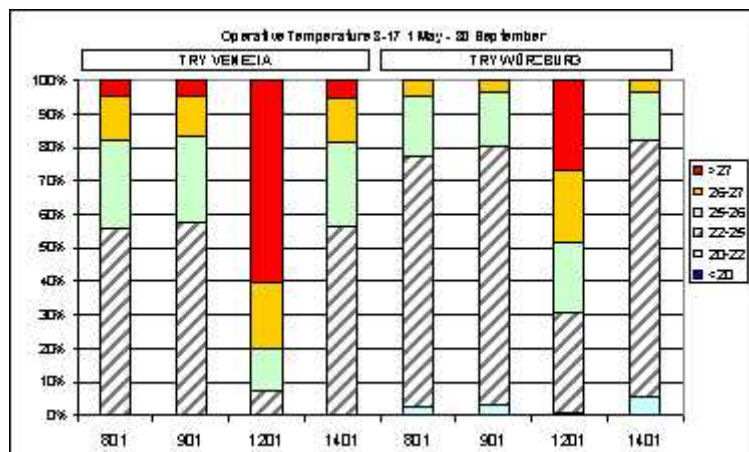

Figure 3.18 – Simulated operative temperature distribution (figure based on the data from Olesen and Dossi 2004)

As can be seen from Figure 3.18, during most of the working hours the operative temperature was within the range 22–25°C. The ranges of operative temperatures were sufficient to meet the requirements of the current standards. Regarding the water circulation pump researchers concluded that its operation only during the night time had almost the same effect as continuous operation. This can be explained by larger temperature difference between the water in the pipe and the concrete core, and therefore a larger heat transfer between core and water.

Evaluation of the energy consumption and thermal comfort in a building equipped with active thermal slabs system was done by De Carli et al. (2003). The computer simulation showed that the office building examined could achieve good comfort conditions. Furthermore, the computer simulations showed that the appropriate use of an active thermal slab system depended on the control strategy applied.

3.1.9. “Claimed” benefits

- As the ventilation systems only have to be sized for the ventilation rate needed for acceptable indoor air quality, ducts can be much smaller and a suspended ceiling is not needed.
- The avoidance of suspended ceilings has the big advantage of reducing the total building height, resulting in significant savings on construction costs and materials used.
- The temperature of the cooling water can be close to desired room temperature. This means high potential for using renewable energy sources (heat pumps, ground heat exchangers etc.), which can operate with high efficiency.
- Due to the utilization of the thermal mass, the cooling system does not have to be designed to cover the maximum heat load. This leads to reduction of the refrigeration equipment or even to its omission.
- When the thermal mass accumulation is used, peak loads from the daytime can be removed during the nighttime when the prices of electricity are lower. This leads to lower operation costs.
- Using surface heating/cooling creates safe and comfortable indoor environment (more space in the rooms, no danger of burns, less dust in the indoor air).

3.1.10. Future perspectives

The technology of TABS is very well developed today. Systems are commercially available. Future development will focus on simplification of the system on-site construction. This requires higher level of prefabrication (not only pipe-coil modules, but also whole concrete blocks, integrated water distributors, fittings etc.). There are several studies showing the use of TABS together with Phase Change Materials (PCM) integrated in building constructions (walls). This approach can be mainly applied for lightweight structure buildings and retrofits. Additional PCM layer of approx. 50mm has the same thermal capacity as 300mm thick concrete wall (Koschenz and Lehmann 2000).

3.1.11. Barriers to application

- TABS are suitable for buildings with low heat/cooling loads (40 – 50 W/m²). High thermal insulation of the building envelope and proper solar shading is necessary.
- There should be the balance between heating losses and cooling loads, so that the system can work optimally (the same heat exchange surface is used for both cooling and heating).
- In office buildings, it is very common to use a raised floor for running cables. In the case of concrete slab cooling most of the heat transfer will then be over the ceiling side, which means suspended ceilings should not be used.
- Without the suspended ceiling, the acoustical requirements must be solved in other ways.

- Buildings with thermo active components cannot be expected to keep a fixed temperature. Further research is needed to evaluate occupant responses to the temperature drifts and the influence of these drifts on the performance of office work.
- Individual control of the indoor thermal parameters is possible only when the TABS are used in combination with additional air-conditioning/heating system.
- High standard of building construction management is needed.
- Optimization of the system, based on the experience, measurements and simulations, is needed in the beginning of operation.

3.1.12. Limitations

- Heating/cooling capacity of the system is approximately 40 – 50 W/m². In buildings with higher need additional systems are needed.
- Individual control is not possible. Building can be divided into zones.
- Non-steady indoor environment – operative temperature drifts can be expected.
- Suspended ceilings should not be used, acoustic problems and lightning installations need careful design.
- During the heating period, there is the risk of cold downdraft at windows, which may be solved by the design of windows with glazing U-factors less than 1.2 W/(m² K), or with an additional heating in the perimeter area.
- Regarding the cooling period, the control of humidity may limit the cooling capacity of the radiant system.

3.1.13. Open questions and future research work to be done

- Combination of the TABS with other responsible building elements (PCM) should be studied
- The relationship between drifting operative temperature and human thermal sensation, prevalence of SBS symptoms and performance should be properly defined.
- Optimization algorithms based on measurements and simulations should be further studied.
- TABS should be tested using different renewable energy sources (solar and geothermal energy, waste heat from industrial processes etc.).
- Comparison of different system combinations should not focus only on energy issues. The construction and running costs of building and system, comfort and productivity of the occupants and the environmental impact must also be considered. Also first costs (including installation) and running costs (including maintenance) during the lifetime of the building should be included in any economic considerations.

3.1.14. References

- Brunello, P., De Carli, M., Di Gennaro, G., Zecchin, R. (2001) "Mathematical modelling of radiant heating and cooling with massive thermal slab", Clima 2000, Naples, Italy. CR 1752 CEN Report (1998) Ventilation for Buildings: Design Criteria for the Indoor Environment.*
- Chapman K S, Wang W: Develop Simplified Methodology to Incorporate Thermal Comfort Factors of Temperature Setback/Setup into Inspace Heating and Cooling design Calculations, Final Project Report, Research project 1114, ASHRAE 2004*
- De Carli, M. (2002) "New Technologies in Radiant Heating and Cooling", Doctoral Thesis, University of Padova, Italy.*
- De Carli, M., Hauser, G., Schmidt, D., Zecchin, P., Zecchin, R. 2003, An Innovative Building Based On Active Thermal Slab Systems", 58th ATI National Conference, San Martino di Castrozza, Italy.*
- De Carli, M., Olesen, B. W. 2001 Field measurements of thermal comfort conditions in buildings with radiant surface cooling systems". Clima 2000, 15th – 18th 2001, Naples, Italy*
- Deecke, H., Guenther, M., Olesen, B. W. 2003 Betonkernaktivierung, Velta Nordestedt, 2003*
- Fort K. (1999) "Type 160: Floor Heating and Hypocaust", Transsolar Energietechnik GmbH, Stuttgart, Germany.*
- Giesecke, F. E. 1946 Hot-water heating and radiant heating and radiant cooling, Technical Book Company, Austin, USA*
- Hauser, G. Kaiser, J., Rösler, M., Schmidt, D. (2004) "Energetische Optimierung, Vermessung und Dokumentation für das Demonstrationsgebäude des Zentrum für Umweltbewusstes Bauen", Abschlußbericht des BMWA Forschungsvorhaben, Universität Kassel, Deutschland.*
- Hauser, G. Kaiser, J., Schmidt, D. 2005 Energy Optimised in Theory and Practice – The Centre for Sustainable Building. Submitted and accepted: Proceedings to the Sustainable Building Conference 2005, September 27-29, 2005, Tokyo, Japan.*
- Hauser, G., Kempkes, Ch., Olesen, B.W. (2000) "Computer simulation of the performance of a hydronic heating and cooling system with pipes embedded into the concrete slab between each floor", ASHRAE Transactions. Vol. 106, Part 1.*
- Koschenz, M., Lehmann, B. 2000 Thermoaktive Bauteilsysteme tabs, EMPA Duebendorf, Schwizerland, ISBN 3-905594-19-6*
- Manley, J. K. 1954 Radiant heating, radiant cooling, School of Architecture, Pratt Institute*
- Meierhans, R. A. 1996 Room air conditionning by means of overnight cooling of the concrete ceiling, ASHRAE Transactions Vol. 102, Pt. 2*

Meierhans, R. A. 1993 Slab cooling and earth coupling, ASHRAE Transactions Symposia, Vol. 99 (2)

Meierhans, R., Olesen B. W. 1999 Betonkernaktivierung, Velta Nordestedt, ISBN 3-00-004092-7

Meierhans, R., Olesen B. W. 2002 House of Art in Bregenz - Soft HVAC for strong architecture, ASHRAE TC.5-Symposium Honolulu, USA

Olesen, B.W. (2000) Cooling and heating of buildings by activating the thermal mass with embedded hydronic pipe systems, ASHRAE-CIBSE Dublin 2000

Olesen, B.W., Dossi, F.C. (2004) "Operation and Control of Activated Slab Heating and Cooling Systems", CIB World Building Congress 2004.

Olesen, B.W., Michel, E., Bonnefoi, F., De Carli, M., 2000 Heat Exchange Coefficient Between Floor Surface and Space by Floor Cooling: Theory or a Question of Definition, ASHRAE Trans. 2000, Part 1

Rekstad, J., Meir, M., Kristoffersen, A. R.: Control and Metering in LTH systems, In: E&B 22, 2003

Schmidt, D., Weber, T., Jóhannesson G. (2000) "Concrete core cooling and heating – a case study", Proceedings of Healthy Buildings 2000, Helsinki, Vol. 2.

TRNSYS 16 (2004) "Update description", University of Wisconsin-Madison, Solar Energy Laboratory Madison, USA.

Weitzmann, P. 2002 Modeling Building Integrated heating and cooling systems, Ph.D. thesis at Department of Civil Engineering, Technical University of Denmark, Lyngby, Denmark, ISBN 87-7877-152-2

Web resources:

www.bauphysik.de/veru

www.rehau.de

www.velta.de

www.zub-kassel.de

3.2. Passive Thermal Mass (PTM)

3.2.1. Component description and example of existing applications

Thermal mass is defined as the mass that has the ability to store thermal energy (heat or cooling energy). Thermal capacity of building mass is defined by ASHRAE (1999) as the amount of heat essential for increase the temperature of a given mass by one Kelvin. Thermal mass is very effective on reducing the wide temperature outdoor temperature fluctuations and keeping the indoor temperature vary within a narrow comfortable range (Asan and Sancakta, 1998). Therefore, thermal mass offers the engineers or architects the powerful opportunity to manage the building energy efficiently.

Historically, there have been many successful passive thermal mass techniques used in buildings. These applications included passive cooling systems, such as night flush cooling and earth cooling etc. (Lechner, 2001), and thermal storage heating system or passive solar heating system, for example, Chinese Kang in northern china, ondol – traditional Korean under-floor heating system (Yeo et al, 2003) and hypocaust in the ancient Rome (Bansal, 1998), but only Chinese Kangs are still widely used today in more than 40 million homes.

3.2.1.1. Description of the component types

According to its location, there are two basic types of thermal mass (Li and Xu, 2006), i.e. external and internal thermal mass.

- The external thermal mass such as walls and roofs are directly exposed to ambient temperature variation.
- The internal thermal mass such as furniture and purpose-built internal concrete partitions are exposed to indoor air temperature.

Various combinations of internal and external thermal mass utilization are possible in a building as shown in Figure 3.19 (Li and Xu, 2006). In their studies, utilization of active thermal mass such as cored slabs or phase change materials as well as the utilization of ground as a part of the building's thermal mass were not addressed. A typical interior wall installation as shown in Figure 3.19B is effectively an internal thermal mass problem if the exterior insulation is perfect. Depending on the relative location of the insulation layer, a concrete wall can act either as internal thermal mass (Figures 3.19B, 3.19D) or external thermal mass (Figures 3.19C, 3.19D).

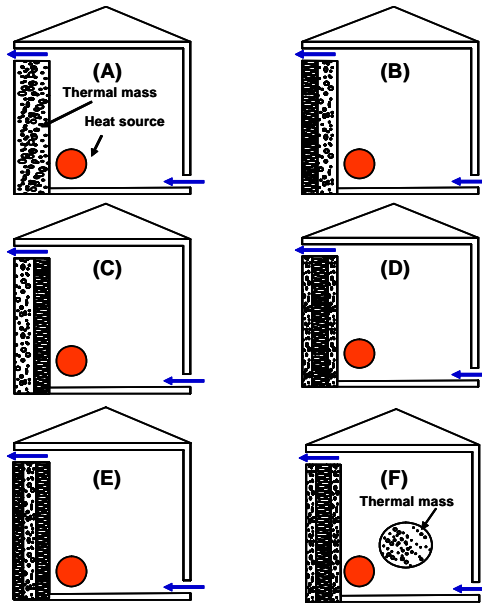

Figure 3.19 – Illustration of six simple building models with different relative location of the thermal mass to the insulation and the existence of internal thermal mass (see Li and Xu, 2006).

The thermal mass can be used both residential and non-residential buildings. There are commercially available systems.

3.2.2. Working principles

For storing heat in buildings, two important thermal properties of the materials should be considered, i.e. the heat capacity by volume and the heat-absorption rate. The first property determines the ability of the materials to store and thermal energy, and the second property determines the ability of the element to adsorb the thermal energy. The combined convective and radiant heat transfer coefficient and the surface area of the thermal mass determine the rate of heat transfer between the thermal mass element and the air. Depending on the interaction of these thermal properties, the thermal mass can shift energy demand to off-peak time periods when electricity is cheaper (i.e. nighttime). The time delay between external maximum and minimum temperature, and the internal maximum or minimum temperature is known as the time lag. Higher thermal mass can significantly reduce the daily fluctuations. Comparison of different representative building materials is shown in Table 3.5.

Table 3.5 – Time lag for 1-foot-thick walls of common building materials (Lechner, 2001).

Material	Time lag (hours)
Adobe	10
Brick (common)	10
Brick (face)	6
Concrete (heavyweight)	8
Wood	20*

*) Wood has such a long time lag because of its moisture content

For a typical internal thermal mass “structure” (Figure 3.20), the basic heat transfer processes can be described as follows:

- Conduction
- Convection
- Radiation

When the outdoor air enters the building by either mechanical or natural forces (i.e. mechanical ventilation, natural ventilation or infiltration), the thermal mass in the building absorbs or releases the heat through its surface and interior body. There is a convective heat transfer process at the surface of the heat mass and a radiant heat transfer between them and other surfaces. The conduction heat transfer takes place in the interior body. For an effective thermal storage and release process, the surface heat transfer rate governing by the convective heat transfer coefficient and the surface area need to be sufficiently large. It is well known that the convective heat transfer coefficient depends on the temperature difference between the thermal mass surface and the surrounding air and the air flow speed around the thermal mass. Generally in the building, it is difficult to enhance the convective heat transfer rate significantly without using a mechanical fan. Thus, the surface area of the thermal mass is a crucial design parameter. The heat penetration through the thermal mass body is by the heat conduction, and the penetration depth is limited by the diffusivity of the material during one cycle (Li and Xu, 2006).

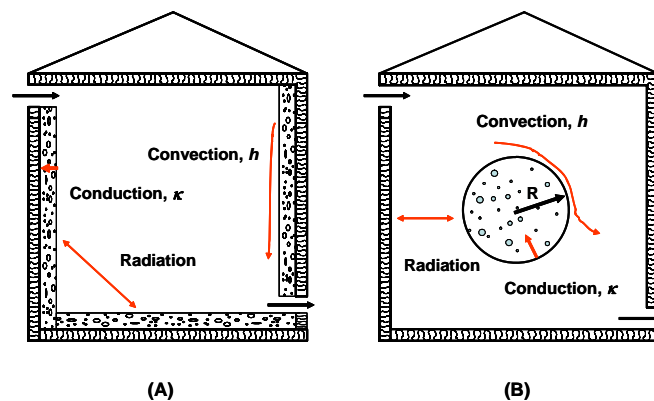

Figure 3.20 – (A) Illustration of use of interior thermal mass in the walls, floor; and (B) Illustrate of the heat transfer process of a thermal mass sphere in a room. (Li and Xu, 2006).

One of the good examples in using thermal mass is the night cooling, which can avoid or minimize the need of mechanical cooling in buildings. During a summer night, the ambient air can circulate in the building and cool the thermal mass. The stored cooling is then released next day to the building.

There are generally two systems (CIBSE, 2001):

- Direct interaction system – the thermal mass directly exposed to the indoor air. Both convection and radiation play roles in heat transfer (see Figure 3.21a).
- Indirect interaction system – the ambient air passes through floor voids, cores and air paths and there is no direct interaction between the room air and the heat mass surfaces. Convective heat transfer is the main heat transfer mode. Mechanical fans may be used to drive the air flow and increase the heat transfer rate, however, design is needed to ensure the fan energy cost do not exceed the mechanical cooling energy saved (see Figure 3.21b).

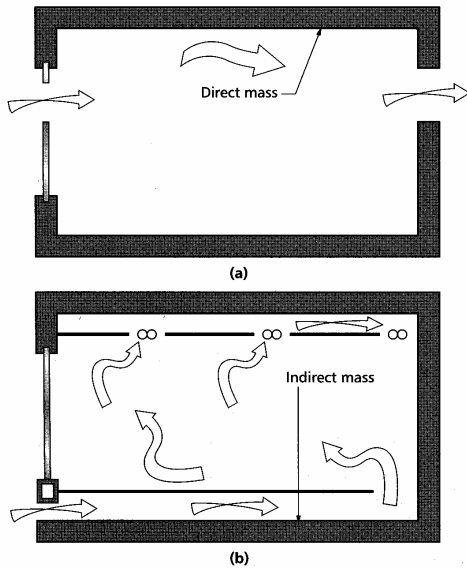

Figure 3.21 – Direct and indirect interaction thermal mass (CIBSE, 2001)

3.2.3. Application field

The thermal mass can be applied with passive cooling or heating techniques to reduce the peak energy loads and indoor air temperature swings.

3.2.3.1 Climate context

In general the application of thermal mass has been found to be particularly suitable for climates with big diurnal temperature variation.

Cooling by night-time ventilation, one of the most efficient applications of thermal mass, can be used if night temperatures are low enough to release heat from the building's thermal mass. Givoni recommends the application of nocturnal convective cooling mainly in arid and desert regions, which have a large diurnal temperature range (above about 15 K) and where the night minimum temperature in summer is below about 20 °C (Givoni, 1990). Especially in commercial buildings with high internal and solar gains (extensive glazed facades) a trend towards increasing cooling demand has been observed even in moderate and cold climates.

Axley and Emmerich analysed the climate suitability for natural ventilation of commercial buildings in different climatic zones of the United States. Cooling by natural ventilation was found to be feasible and effective in the cooler locations for moderate to high specific internal gains, but not for hot and humid climates, as for example in Miami, FL, where relatively high night-time ventilation rates would be needed to offset moderate specific internal gains. (Axley and Emmerich, 2002).

For Europe the climatic potential for passive cooling of buildings by night-time ventilation has been analyzed by Artmann et al. using a degree-hours method. It was shown that in the whole of Northern Europe (including the British Isles) there is very significant potential for cooling by night-time ventilation and this method therefore seems to be applicable in most cases. In Central, Eastern and even in some regions of Southern Europe, the climatic cooling potential is still significant, but due to the inherent stochastic properties of weather patterns,

series of warmer nights can occur at some locations, where passive cooling by night-time ventilation might not be sufficient to guarantee thermal comfort. If lower thermal comfort levels are not accepted during short time periods, additional cooling systems are required. In regions such as southern Spain, Italy and Greece climatic cooling potential is limited. Nevertheless, passive cooling of buildings by night-time ventilation might be promising for hybrid systems (Artmann et al., 2006).

3.2.3.2 Location of the element

Different locations of thermal mass in buildings can result in distinctively different behaviours. For external thermal mass design, the orientation of the wall elements surface and its desirable time lag are two key factors as different orientation experiences its major heat gain at a different time. For example, north walls have little need for time lag as they exhibit small solar heat gains. The east wall has a high morning load and it is desirable to have either a very long time lag (more than 14 hours) to ensure that the heat transfer is delayed until the evening, or a very short one. However, to have more than 14 hours time lag would need a lot of thermal mass materials, which are expensive. Thus the latter case is recommended. For south and west walls, an 8-hour time lag is sufficient to delay the heat until the evening hours. For the roof, which is exposed to solar radiation during most hours of the day, a very long time lag is also required. However, the use of additional insulation is usually recommended as it is very expensive to construct the heavy roofs. Thus the most important envelope elements are the south and west walls, as well as the roof. However, the general guidelines do not apply to internal thermal mass design. Proper engineering design or simulation is necessary to ensure the proper design of the thermal mass and insulation.

3.2.3.3 Suitability for use with the other building components

Night ventilation is one of the best applications of thermal mass (Van der Maas J and Roulet, 1991).

Phase Changing Materials (PCM) can be used to increase the amount of thermal mass.

3.2.4 Available design tools

A large number of the previous studies and computational methods on thermal mass were reviewed (Balaras, 1996). Sixteen different parameters were found for describing thermal mass effects, such as the total thermal time constant (Givoni, 1976), the admittance factor (Burberry, 1983), diurnal heat capacity (Balcomb, 1983), the thermal effectiveness parameter (Ruud et al., 1990), and the effective thermal storage (Mathews et al., 1991; Antonopoulos and Koronaki, 1998). There were also many studies on different factors affecting the thermal mass performance, such as the surface area of thermal storage (Sodha et al., 1992), the wall properties (Asan and Sancakta, 1998), and the thickness of the wall (Antonopoulos and Koronaki, 2000).

CIBSE Guide Volume A (1988) derived some factors for analyzing the transient behavior of a building structure. These factors, including the admittance, decrement factor and surface factor, are the functions of the thickness, thermal conductivity, density and specific heat

capacity, as well as locations of the materials. However, the CIBSE method may not be used directly for thermal design.

Generally, constant mechanical ventilation was assumed in many thermal mass researches (for example, Shaviv et al., 2001). Yam et al. (2003) studied the effect of internal thermal mass associating with the non-linear coupling between the natural ventilation and the indoor air temperature and also proposed a new concept of virtual sphere method for effective thermal mass design (Li and Yam, 2004). In this method, three key design parameters, including the time constant (τ), convective heat transfer number (λ) representing the relative strength of convective heat transfer at the thermal mass surface, and the Fourier time constant (η) characterizing the effectiveness of heat exchange within the virtual sphere, were proposed. These concepts can form a complete set of governing parameters for thermal mass design.

In practice, thermal mass is often designed by architects and engineers using empirical methods. For thermal mass materials with different geometry shapes in a building, it is benefit to analyze all these thermal mass elements by using one geometric mass. Therefore, a virtual sphere representing a mass with arbitrary geometry for modeling thermal mass was developed. The concept of the virtual sphere method, originally proposed by Gao and Reid (1997), is to use a virtual sphere to represent the work piece of any geometry. The idea of virtual sphere originates from the similarity of the Heisler charts for the center temperature of infinite plate, long cylinder and solid sphere. If the same characteristic length is used, the three Heisler charts were found to be nearly identical, although not exactly identical. The idea is to lump up the mass elements into a virtual solid sphere with the radius determined from some significant dimensions of the mass (e.g. volume and surface area) (Li and Yam, 2004; Li and Xu, 2006). This approach would conserve calculation time as large-scale heat transfer calculation of the mass elements is avoided. The method could not give accurate results, but yet provide some guideline for the building thermal mass design. The characteristic length or radius of the virtual sphere is determined by the following formula

$$R = \frac{3V}{A}$$

where V is the volume and A is the effective surface area.

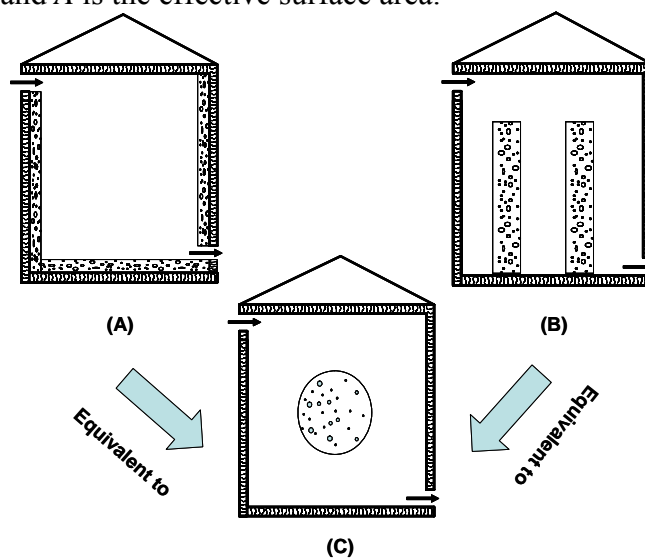

Figure 3.22 – Illustration of representing interior thermal mass in the walls, floor or even ceiling (A) or interior thermal mass (B) as a virtual sphere (C) (Li and Xu, 2006).

Using the virtual sphere concept and three important design parameters characterizing the thermal properties of the elements, simple general design method was developed (Li and Xu, 2006).

Step 1: Identify each internal thermal mass element i in a building.

Step 2: Estimate the total ventilation flow rate.

Step 3: Estimate the effective U -value of all external wall elements ($j=1, \dots, N_j$).

Step 4: Estimate the three thermal mass design-related parameters.

Step 5: Estimate the phase shift of the indoor air temperature and attenuation factor.

There are also several more complex tools - advanced programs. They often require a great amount of input information, but provide highly accurate results. Some of them are well-known software packages available on the market, for example ESP (Clarke, 1985) and TRNSYS (Klein, 1988). They are more likely to be used by people with advanced knowledge.

3.2.5. Availability of measured performances (labs. and field measurements)

Givoni (1998) presented some experiments on the effectiveness of thermal mass and night ventilation in lowering the indoor air temperature during daytime. The experiments, conducted in the summer 1993 in Pala, South California, investigated buildings with different thermal mass levels under different ventilation or shading conditions. It was found that, for building with light construction, night ventilation had only a very small effect on reducing indoor maximum temperatures. However, it was very effective to lower indoor maximum temperatures for the building with high thermal mass (heavy construction). Also a simple predictive formula for indoor air temperature was developed and found to be applicable to a wider range of climatic conditions.

Ogoli (2003) developed four environmental test chambers with different thermal mass levels and monitored the effect of thermal mass in lowering the maximum indoor daytime temperatures in Nairobi, Kenya, during the warm season in 1997. High thermal mass was observed to be very effective in lowering indoor maximum temperatures. Cheng et al. (2005) demonstrated the effect of envelope color and thermal mass on indoor temperatures in hot humid climate. The results revealed that the use of lighter surface color and thermal mass can dramatically reduce maximum indoor air temperature but the practical applications could be different and depend on the circumstances. The possibility to develop predictive formulas for daily maximum indoor temperature was analyzed and discussed.

3.2.6. Availability of simulated performances

The performance of building thermal mass is dependent on the type of building, building structure, its operating schedule, internal loads, external shading and the climatic conditions (Santamouris and Asimakopoulos, 1996). A large number of investigations and studies were focused on the possible benefit of using thermal mass in building to reduce the cooling or heating load.

Goodwin and Catani (1979) investigated the effect of thermal mass on cooling load and on insulation requirements in different climates. Three types of buildings were selected to study the relationship between mass and cooling load. The results showed that adding insulation to walls can increase the cooling load while the mass is effective in reducing cooling load. In the study, the cooling requirements of the buildings averaged 22 % less for heavier constructions.

By using ESP program, the simulations on the role of thermal mass effects in Greek buildings were carried out (Argirious, 1992). The thermal behavior of two types of buildings (single-zone and two-zone) was calculated for 13 different building materials (e.g. different amounts of building thermal mass). The annual cooling load per square meter of floor area were shown as a function of the effective thermal mass. And the reduction of cooling load is significant up to thermal mass approaching a particular value.

In Cyprus, Kalogirou et al. (2002) simulated the effects of building thermal mass on the heating and cooling load. A typical four-zone building with an insulated roof, in which the south wall of one zones was replaced by a thermal wall, was modeled by using the TRNSYS program. The possible benefits were investigated from this application. There was a significant reduction in the heating load, while a slight increase of cooling load. And the wall thickness was very important for determining the room temperature.

Macias et al. (2006) used two simulation tools (i.e. TRNSYS and TAS) to simulate a passive night cooling system. The passive cooling system incorporated a solar chimney in combination with high thermal mass in the building construction. The storage chimney was found that it can help enhance the night ventilation to cool the building structure, as well as reducing the cooling load.

In addition, the performance of thermal mass in different types of buildings for different climate zones were simulated (for example, Ober and Wortman, 1991; Shaviv, 1988).

3.2.7. “Claimed” benefits

- The thermal mass of the building can have a positive effect on the indoor environment during the summer and winter period. In summer, heat is stored at daytime in the thermal mass, thus reducing the cooling load peaks. At nighttime, the night ventilation can help the heat release from the thermal mass. In winter, the stored heat is transferred back into the room during the late afternoon and late evening hours, reducing the heating demand.
- Thermal mass has also a positive effect on occupant’s comfort through keeping the indoor air temperature within, in comparison to outdoor temperatures, relatively narrow range.
- When combined with passive cooling or heating techniques, the thermal mass elements have high energy conservation potential.

3.2.8. Future perspectives

The technology of passive thermal mass is very well developed today. Some the new design strategies were developed by combining passive and active techniques together, such as activation of the thermal mass or utilization of phase change materials in building constructions.

3.2.9. Barriers to application

- The effect of thermal mass is dependent on the climate context.
- The thermal properties of thermal mass elements and surrounding environment should be considered to exert its storage ability.
- For an effective thermal storage and release process, the surface heat transfer rate governing by the convective heat transfer coefficient and the surface area need to be sufficiently large. It is generally difficult to enhance the convective heat transfer rate significantly without using a mechanical fan. Thus, the surface area of the thermal mass is a crucial design parameter.

3.2.10. Limitations

N/A

3.2.11. Open questions and future research work to be done

As stated before, the heat transfer between the room air and the thermal mass is crucial for an effective storage process. Depending on air flow patterns the convective heat transfer can vary significantly, especially in buildings using natural ventilation for night-time cooling. However, commercial building energy simulation codes normally use one homogenous air temperature for each zone and simplified models for the convective heat transfer coefficient. Therefore improved modelling algorithms in building energy simulation codes are required in the field of air exchange and heat transfer to assure a reliable prediction of the heat storage in thermal mass and the performance of passive cooling by night-time ventilation.

3.2.12. References

- Antonopoulos, K. A. and E. P. Koronaki. 1998. *Apparent and effective thermal capacitance of buildings*. *Energy* 23(3): 183-192.
- Antonopoulos, K. A. and E. P. Koronaki. 2000. *Thermal parameter components of building envelope*. *Applied Thermal Engineering* 20(13): 1193-1211.
- Argirious, A. 1992. *A study of thermal mass in Hellenic buildings*. Institute for technological applications, Hellenic productivity centre, Athens, September.
- Artmann N, Manz H, Heiselberg P. 2006. *Climatic potential for passive cooling of buildings by night-time ventilation in Europe (accepted for publication in Applied Energy, May 8, 2006)*
- Asan, H. and Y.S. Sancaktar. 1998. *Effects of wall's thermophysical properties on time lag and decrement factor*. *Energy and Buildings* 28(2):159-166.
- ASHRAE. 1999. *ASHRAE handbook – HVAC applications*. Atlanta: American Society of Heating, Refrigerating and Air-Conditioning Engineers, Inc.
- Axley JW, Emmerich SJ. 2002. *A method to assess the suitability of a climate for natural ventilation of commercial buildings*. *Proceedings: Indoor Air 2002, Monterey, CA*
- Balaras, C. A. 1996. *The role of thermal mass on the cooling load of buildings. An overview of computational methods*. *Energy and Buildings* 24(1):1-10.
- Balcomb, J. D. 1983. *Heat storage and distribution inside passive solar buildings*. In: *Proceedings of the 2nd International PLEA Conference: 547-561*.
- Burberry, P. 1983. *Practical Thermal Design in Buildings*. London: Batsford Academic and Educational Ltd.
- Cheng, V., E. Ng, and B. Givoni. 2005. *Effect of envelope colour and thermal mass on indoor temperatures in hot humid climate*. *Solar Energy* 78(4):528-534.
- CIBSE. 1988. *CIBSE Guide Volume A Design Data*. Chartered Institute of Building Services Engineers (CIBSE), London, UK.
- CIBSE. 2001. *CIBSE Guide B2 – Ventilation and Air Conditioning*. Chartered Institute of Building Services Engineers (CIBSE), London, UK.
- Clarke, J. 1985. *Energy simulation in building design*. Adam Hilger Ltd, Bristol.
- Mathews, E. H., P. G. Rousseau, P. G. Richards, and C. Lombard. 1991. *A procedure to estimate the effective heat storage capability of a building*, *Building and Environment* 26 (2): 179-188.
- Gao, M. and C. N. Reid. 1997. *A simple virtual sphere method for estimating equilibration*

- times in heat treatment. *International Communications in Heat and Mass Transfer* 24 (1): 79-88.
- Givoni, B. 1976. *Man, Climate and Architecture*. 2nd ed. London: Applied Science.
- Givoni, B. 1990. Performance and applicability of passive and low-energy cooling systems. *Energy and Buildings*, 17 (1991) 177-199
- Givoni, B. 1998. Effectiveness of mass and night ventilation in lowering the indoor daytime temperatures. Part I: 1993 experimental periods. *Energy and Buildings* 28(1):25-32.
- Goodwin, S. and M. Catani. 1979. The effect of mass on heating and cooling loads and on insulation requirements of buildings in different climates. *ASHRAE Transactions*, 85(1): 869-884.
- Kalogirou, S. A., G. Florides, and S. Tassou. 2002. Energy analysis of buildings employing thermal mass in Cyprus. *Renewable Energy*, 27(3): 353-368.
- Klein, S. et al. 1988. TRNSYS – a transient system simulation program. University of Wisconsin-Madison, Engineering experiment station report 38-12.
- Lechner, N. 2001. *Heating, cooling, lighting: design methods for architects*, 2nd Ed. New York: John Wiley & Sons.
- Li, Y. and P. Xu. 2006. In press. Thermal mass design in buildings – heavy or light? *International Journal of Ventilation, Special Edition* 5(1): 143 - 150
- Li, Y. and Y. Yam. 2004. Designing thermal mass in naturally ventilated buildings. *International Journal of Ventilation*. 2(4): 313-324.
- Macias, M., A. Mateo, M. Schuler and E.M. Mitre. 2006. Application of night cooling concept to social housing design in dry hot climate. *Energy and Buildings*. In press.
- Ogoli, D. M. 2003. Predicting indoor temperatures in closed buildings with high thermal mass. *Energy and Buildings* 35: 851-862.
- Ober, D. and D. Wortman. 1991. Effect of building type on wall thermal mass performance. *ASHRAE Journal*, 33(11): 18-21.
- Ruud, M. D., J. W. Mitchell, and S. A. Klein. 1990. Use of building thermal mass to offset cooling loads. *ASHRAE Transactions* 96 (pt. 2): 820-829.
- Santamouris, M and D. Asimakopoulos. 1996. *Passive cooling of buildings*. London: James & James Ltd.
- Shaviv, E. 1988. On the determination of the optimum thermal mass in the Mediterranean climate. In: *Energy and Buildings for Temperate Climates*, 6th International PLEA conference, Porto, Portugal, eds E. de Oliverira Fernandes and S. Yannas, Oxford: Pergamon Press, 385-390

- Shaviv, E., A. Yezioro, and I.G. Capeluto. 2001. Thermal mass and night ventilation as passive cooling design strategy. Renewable Energy 24(3-4):445-452.*
- Sodha, M. S., J. Kaur, and R. L. Sawhney. 1992. Effect of storage on thermal performance of a building. International Journal of Energy Research 16: 697-707.*
- Yam, J.Y, Y. Li, and Z.H. Zheng. 2003, Nonlinear coupling between thermal mass and natural ventilation in buildings. Int J of Heat and Mass Transfer 46(7): 1251-1264.*

3.3. Examples of commercially available components/technologies for thermal mass applications

3.3.1 The TermoDeck system

3.3.1.1. Component description and working principle

The TermoDeck® system was developed in Scandinavia by two Swedish engineers Mr. Loa Anderson and Dr. Engelbrekt Isfält in the 1970s. Since 1970s over 360 buildings have been constructed incorporating TermoDeck, mainly in Scandinavia, Northern Europe, UK, the Middle East and North America. In the early days Termo Deck concentrated on office type buildings but nowadays the applications are spread to school buildings, hotels theatres, hospitals and public buildings.

TermoDeck is an airborne thermally activated building system. Ventilation air is led through ducts in a concrete slab placed in the ceiling, which is used as thermal mass. TermoDeck has primarily been used in office type buildings but also in school buildings, hotels theatres, hospitals and public buildings.

The TermoDeck® system is a thermally activated building system, TABS, using ventilated hollow concrete core slabs.

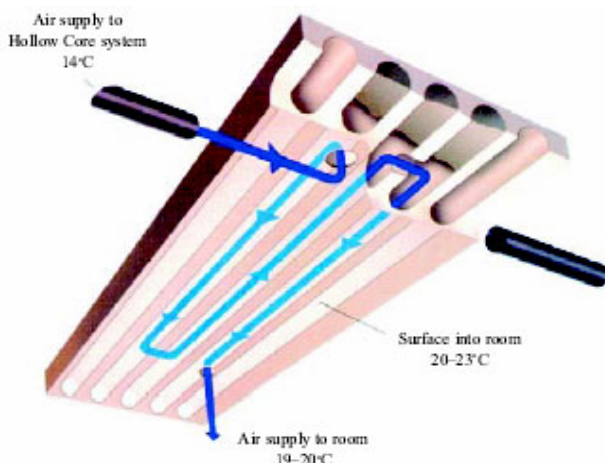

Figure 3.23 Principle of the TermoDeck® system.

The system consists of prefabricated hollow core concrete elements of width 1.2 m. The maximum span of the element is 18 meters. The thickness of the elements varies with the span.

The standard system can be operated both for cooling and heating. Figure 3.2.2 shows how the slabs are incorporated into the building. The elements are fed with ventilation air from a main supply duct, which runs along a central corridor. Normally they are located behind a suspended ceiling. Air is supplied to the rooms through supply diffusers located in the ceiling and the air is extracted from the room through extract grills located at ceiling level.

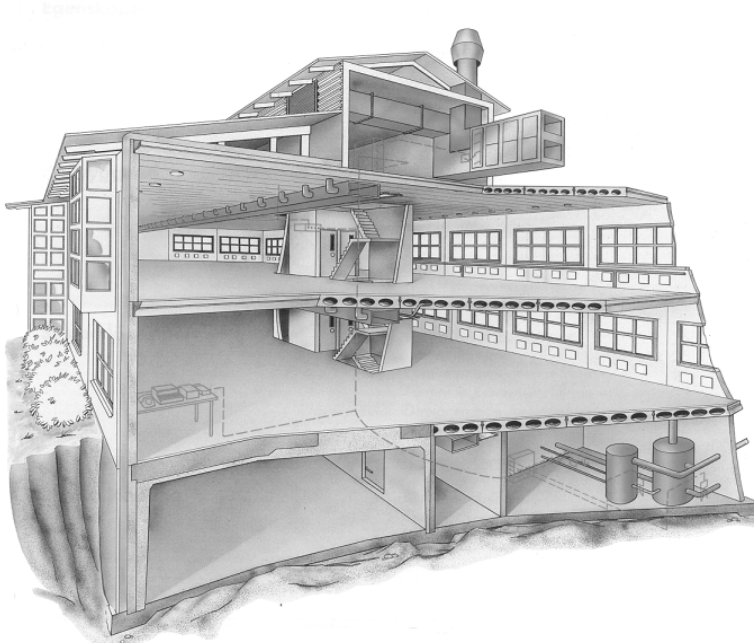

Figure 3.24 Built up of system

3.3.1.2. Example of Installations



Figure 3.25 The Met Office Relocation in UK

The building is provided with the TermoDeck Ventilation System”. With the aim of saving energy a number of designed solutions were introduced. Heat recovery in the air-handling units, motion detection on the lighting and a combined Heat and Power plant on-site.



Figure 3.26 The Elisabeth Fry Building of East Anglia in UK

3.3.1.2.1. On going projects

Independent studies of the performance of TermoDeck are very rare. In a project called SYMPHONY dealing with industrial production of Multi-Family Buildings hollow concrete slabs are used. Within this project the performance of TermoDeckk will be recorded. A three story experimental building called the Research Tower has been erected, see Figure 3.2.5.



Figure 3.27 The Research Tower Left Under constructions Right Finished

3.3.1.3. Claimed benefits and future perspectives

3.3.1.3.1. Erection time and Capital costs

The erection time for a pre-fabricated building compared to a conventional cast in situ concrete building can be reduced by up to 30 %.

There is a reduction in capital cost due to a reduction in fans, chillers, ducts and radiators (in hot climates 40-50 %). Furthermore there is no need for suspended ceilings.

There is no need for a ceiling void and therefore the storey heights may be reduced by 15-25 % per floor.

3.3.1.3.2. Peak power reduction

In the range 45-50 % reduction in installed electrical power and cooling capacity. During 4-5 hours over the midday period, the reduction can be as high as 70-100 %.

3.3.1.3.3. Reduced Energy Consumption

TermoDeck projects In Europe have up to 40% lower energy consumption for heating whereas TermoDeck projects in Middle East have 15.30 % lower electrical bills than equally sized conventional buildings.

3.3.1.4 Possible barriers

The suitability of using concrete ducts for building ventilation has been an issue discussed over many years. The questions have been:

- Do concrete ducts emit particles to the ventilation air?
- Do concrete ducts cause a smell of cement in the ventilated room?
- Is it possible to clean concrete ducts?

Regarding the first issue a number of studies were carried out in the 1980's. In all studies the result was the same. Compared to standard ductwork of sheet metal concrete ducts do not increase the risk of fungal growth or other hygienic related problems.

Smell of cement does not occur unless the concrete is newly made or if there is water damage.

Regarding cleaning a number of systems has been developed. One system is called Jet vent uses a combination of compressed air and vacuum technology. Compressed air is blown into the duct with a nozzle whose direction can be changed 360°. At the same time air is sucked with a vacuum pump connected to the slab with a hose, see Figure 3.2.6.

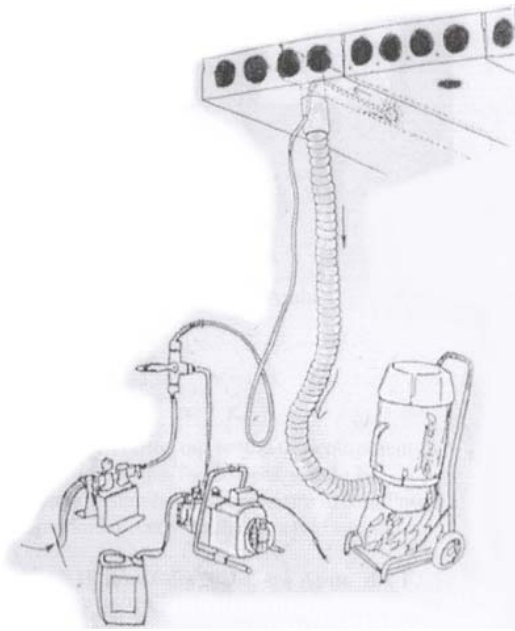

Figure 3.28 The Jet vent system for cleaning

3.3.1.5. References

Smith, J.T. and Raw, G.J. (1999) The suitability of TermoDeck modules for use in building ventilation systems. BRE (Building Research Establishment Ltd)

Karlström S (2005) TermoDeckRevisited Master of Science Thesis Department of Building Technology KTH Stockholm

3.3.2. An air conditioning system utilizing building thermal storage (ACSuBTS)

3.3.2.1. Component description and example of existing applications

Recently, the highest peak electricity demand occurs in midday during summer in Japan. An air conditioning system utilizing building thermal storage (ACSuBTS) can smooth the cooling load without increasing the initial costs, by using the large building thermal mass as a thermal storage medium. In summer, by keeping the climate control system operating at night, the flooring slabs, furniture and interior materials are cooled down. Then cool exergy stored in the building construction can be used to reduce electricity consumption of mechanical cooling during the peak electricity usage period.

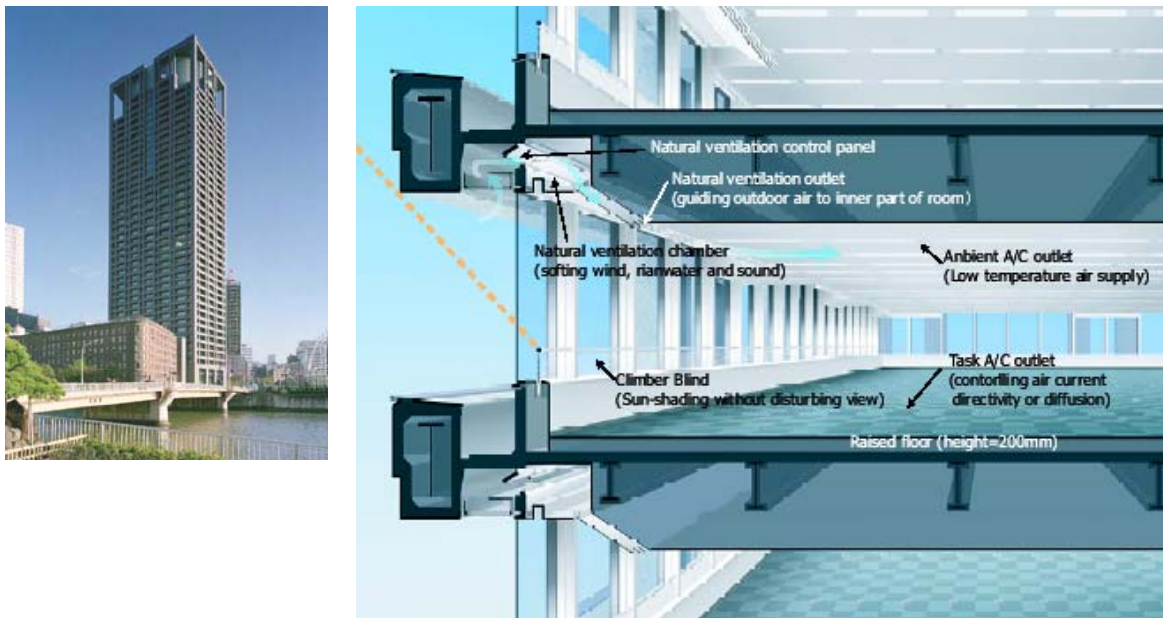

Figure 3.29 - Existing application KANDEN Building of Kansai Electric Power Company, Inc. (KEPCO) in Osaka

3.3.2.2. Working principles

Dampers are installed at supply air ducts in order to change over the air supply to the working space or to the plenum chamber. During the working hours, the conditioned air from the air conditioning unit is blown directly to the room through the supply duct by opening the changeover dampers. The return air from the room through the opening in the ceiling panel is mixed with the air in the plenum and then flows into the air-conditioners. During night, the conditioned air is blown directly upon the floor slab by changing angle of the dampers and cools down the floor slab.

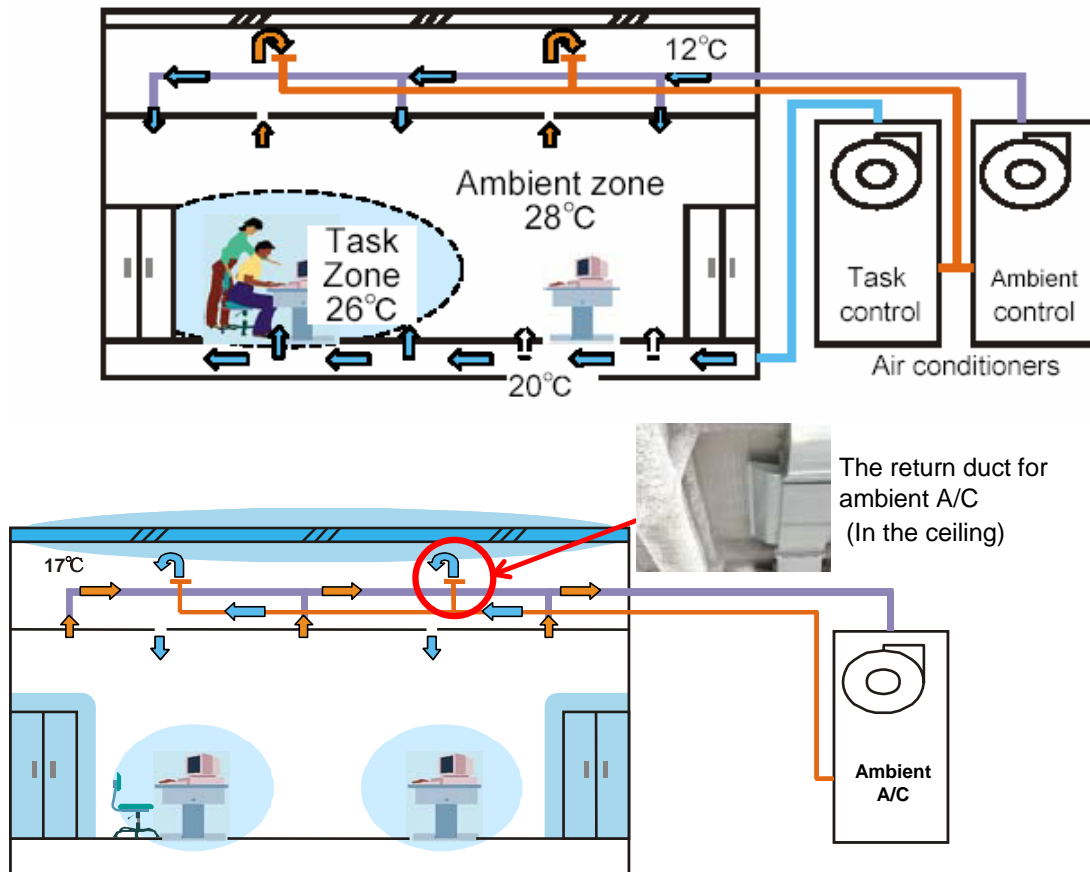

Figure 3.30 – Air conditioning system utilizing building thermal storage – operation principle

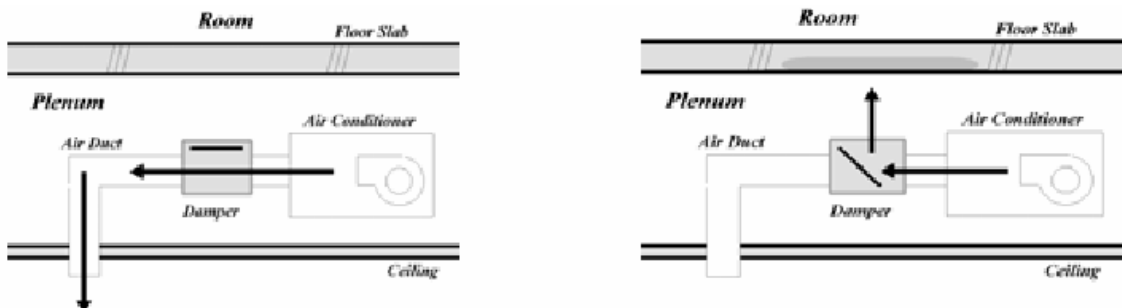

Figure 3.31 - Control of damper (left: working hours, right: thermal storage hours)

3.3.2.3. Application field

Almost all of the air conditioning systems utilizing building thermal storage are for office buildings.

3.3.2.4. Available design tools

Since the horizontal temperature distributions in the floor slab and the plenum are significantly non-uniform, a two-dimensional simulation program for calculating thermal

conduction in the solid materials combined with calculation of the airflow and air temperature are used as a design tool. Outdoor conditions (air temperature and solar radiation), supply air conditions (temperature, airflow rate), internal heat generations (lightings, computers and occupants), and properties of materials are used as inputs to the simulation.

3.3.2.5. An example of simulation

The figure below shows the simulation model for airflow in the plenum in KANDEN building. The room is divided into two zones that are the perimeter and interior zones. The plenum was divided into 75 rectangular cells. The airflow rate from the air-conditioners into the plenum was kept constant during working and accumulation period, respectively. During the accumulation period, imaginary walls indicated by broken lines were assumed in both sides of the upper cell to the changeover damper in order to give upward inertial force to the supply air. The block-model (Togari et al. 1991) was used for an analysis of the airflow in the plenum. The cell pressure was calculated by Newton method, where an air density ρ was assumed uniform. The cell temperature was calculated by the heat flux due to airflow and heat transfer from the wall. Since the air temperature changes faster than the concrete slab temperature, the cell temperature was calculated assuming a steady state.

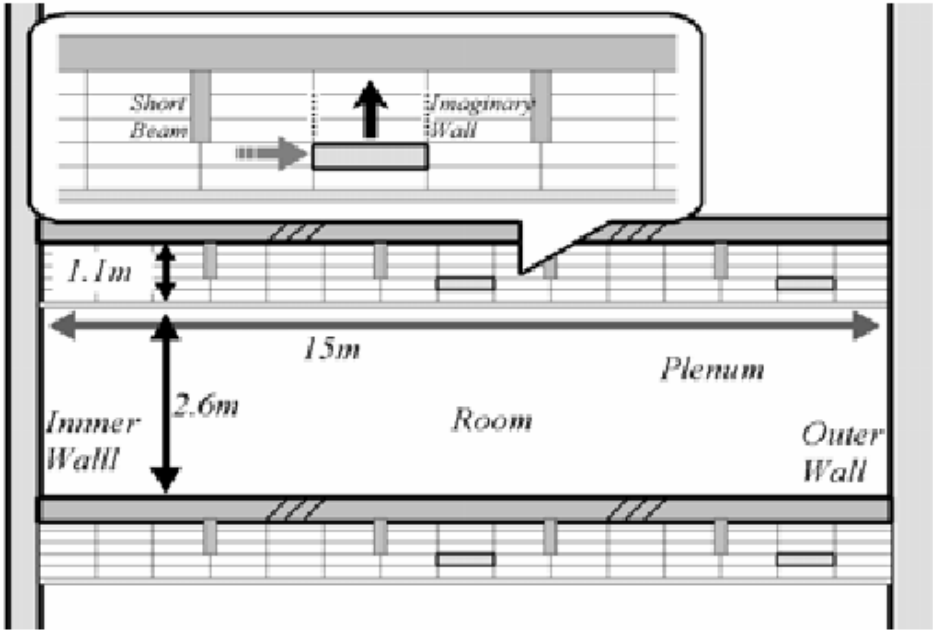

Figure 3.32 - Cell division for plenum

3.3.2.6. Available experimental procedure to assess element performances

- Measurement of the cooling load (estimation based on the airflow rate and the difference between the measured supply and return air temperatures)
- Measurement of the slab temperature
- Measurement of the air temperature at the supply, in the room, plenum and outdoors.
- Measurement of the solar radiation

3.3.2.7. Example of measurement

Measurement was carried out in the KANDEN building between 5th and 9th August. The temperatures of the slab were measured at five points shown in the figure below (marked from 1 to 5), while the room air temperatures are measured at two points (marked 6 and 7). Air conditioners had been installed in the perimeter (near point 1) and interior space (near point 3), and they could be operated independently. Figure 3.33 shows the measured values of the outdoor air temperature and the horizontal solar radiation. The working hours were from 8:00 to 19:00 (from 5th to 9th), while heat storage hours were from 22:00 to 8:00 on the following day (from 6th to 8th). Outlet air temperatures were measured at the upper part of the changeover damper.

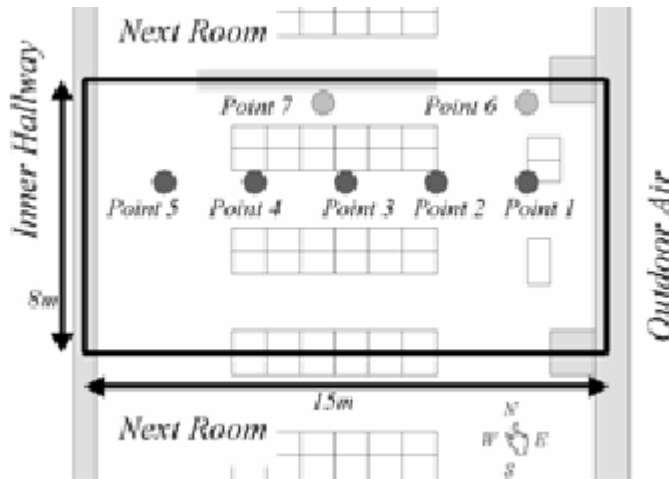

Figure 3.33 – Position of measuring points at the typical floor of the KANDEN building.

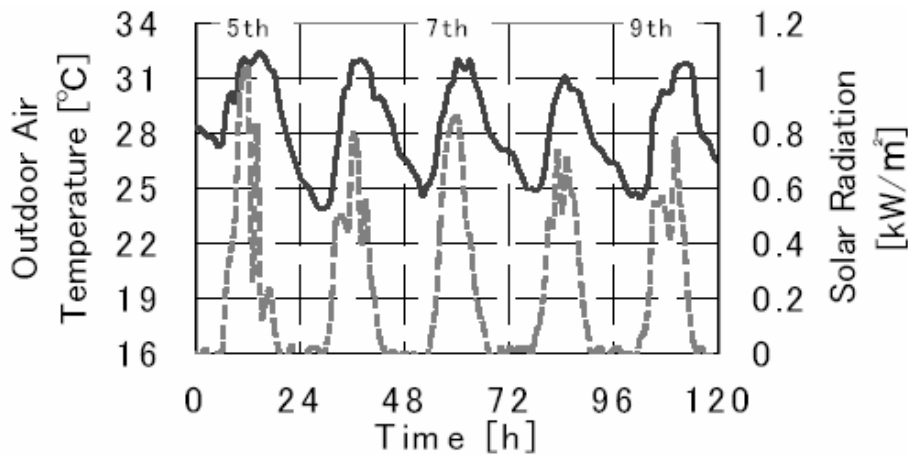

Figure 3.34 - Weather conditions

3.3.2.8. Availability of measured performances

3.3.2.8.1 Example of measured performance

The cooling load, determined based on the measurements of the airflow rate and the difference between the supply and return air temperatures, is shown in the Figure 7 (left). Comparison of the cooling load on 6th Aug. (without thermal storage) and that on 9th Aug.

(with thermal storage) indicates a significant reduction of the peak cooling load (about 30 %). Figure 3.35(right) shows the air temperatures at the measuring points number 6 and 7 in the room. The temperatures decrease due to the air leakage in the plenum during thermal storage hours.

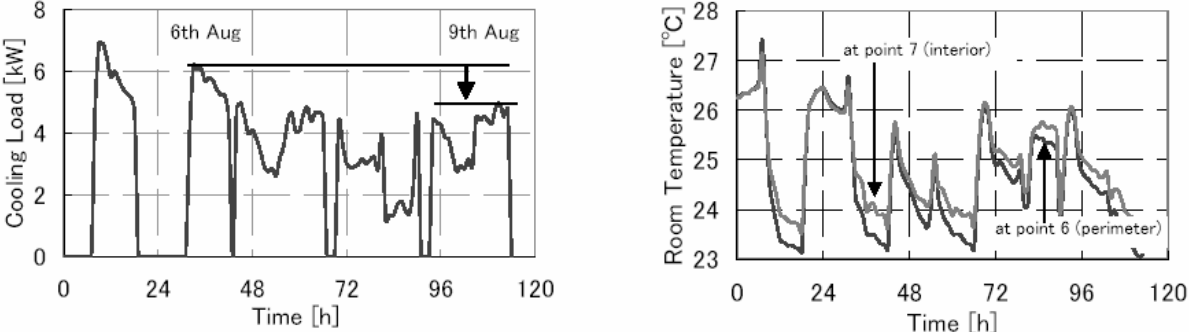

Figure 3.35 – Cooling load (left) and room air temperature (right) for measuring points number 6 and 7 of the examined room in KANDEN building

Temperatures at several positions through the floor construction, that is, the surface of the carpet tile, the upper and lower surfaces of the concrete slab, at the measuring point 3 (see Figure 5) are shown in Figure 8(left). At the point 3, which is located near the changeover damper, heat is released during the thermal storage hours, while absorbed during the working hours. Thus, heat is stored effectively to the floor slab at the point 3. During thermal storage hours, the temperature on the lower surface of the concrete slab (left figure) is almost equal to the air temperature blown through the upper opening of the changeover damper. It can be judged that the air impinges on the lower surface of the concrete slab directly. At the measuring point 4, far from the changeover damper (Figure 3.36 (right)), none of the floor temperatures show any appreciable change from 24°C throughout the day. Thus, heat storage to the floor near the point 4 cannot be expected.

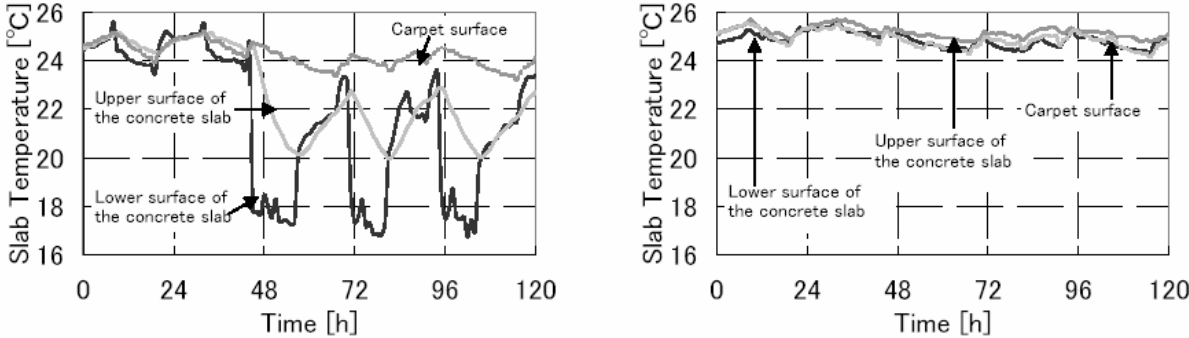

Figure 3.36 - Vertical distribution of floor slab temperature at measuring point number 3 (left) and number 4 (right)

3.3.2.9. Availability of simulated performances

3.3.2.9.1 Example of simulated performance

The measured and simulated values of the lower surface are compared in figures below, cooling load and the lower surface temperatures of the slab. The simulated results agree fairly well with the measured.

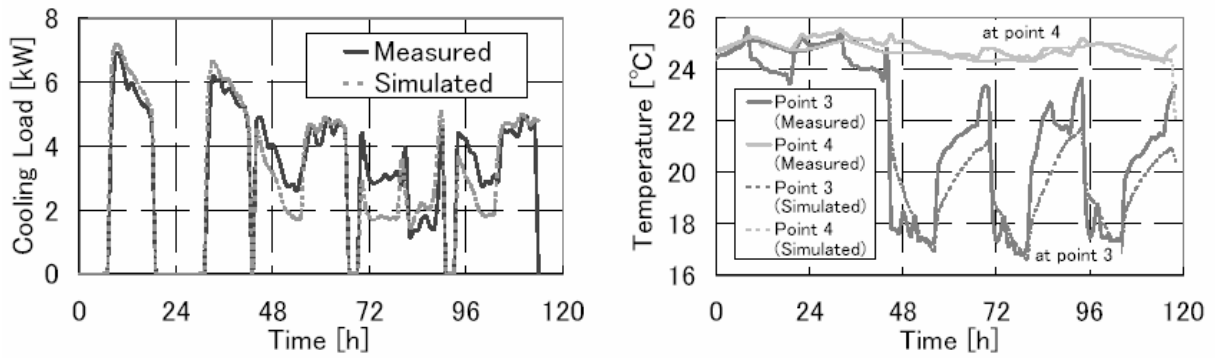

Figure 3.37 – Comparison of measured and simulated results (left: cooling load, right: lower surface temperatures of slab at points 3 and 4)

3.3.2.9.2 Example of simulation for improving the performance

Due to the non-uniform horizontal temperature distribution in the floor slab, the thermal storage potential of the floor slab can not be fully utilized for cutting the peak load. Therefore, the simulation model was used to predict the performance of the thermal storage after the improvement of the air circulation in the plenum. A hole was assumed to be in the short beams and extend the imaginary walls in order to improve the air circulation as depicted in the Figure 10 (bottom).

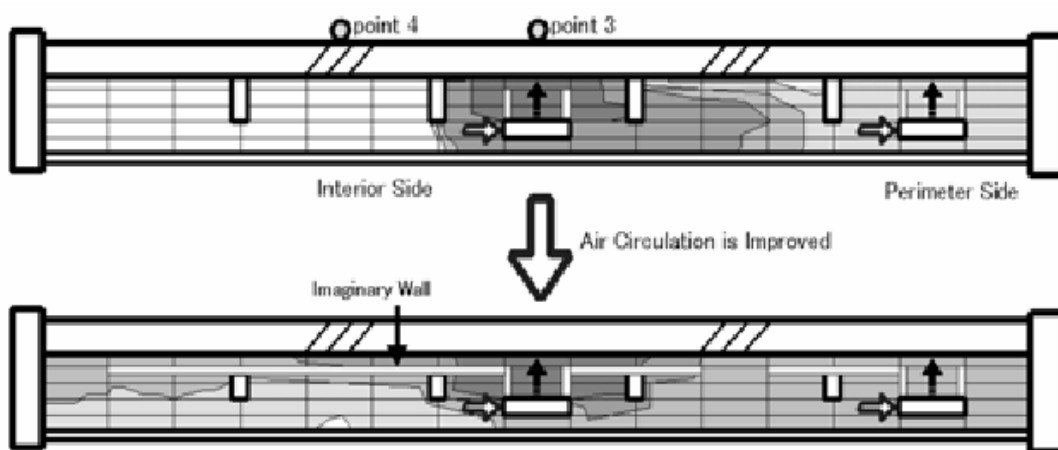

Figure 3.38 - Temperature distribution in the plenum during heat storage hours (top: without improvement, bottom: with the improvement)

Because of this improvement, the non-uniformity in the temperature distribution in the plenum was significantly reduced. Owing to the improved uniform horizontal temperature distribution in the floor slab as shown in Figure 11(left), the cooling load shifts to the storage hours can be seen in Figure 11 (right).

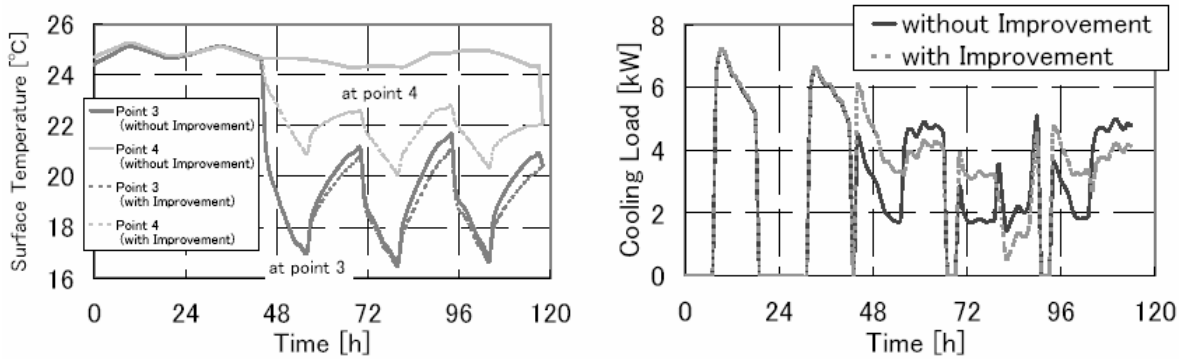

Figure 3.39 - Calculated lower surface temperature of the slab (left) and cooling load (right) when air circulation is improved.

3.3.2.10. “Claimed” benefits and limitations

- The mechanism of the ACSuBTS is simple and easy to introduce in to the practice.
- Initial cost of the ACSuBTS is lower than the conventional thermal storage systems because it does not have the thermal storage tank.
- ACSuBTS can use cheaper electricity at night.
- The thermal storage capacity of the ACSuBTS is not so large.
- The control of thermal storage and release is difficult.
- The thermal storage effect in the slab far away from the supply air outlet is small.

3.3.2.11 Future perspectives

If there are opportunities to apply ACSuBTS to other buildings, it would be interesting to apply more effective system layout and examine its performance by simulations validated by field measurements.

3.3.2.12. Barriers to application

There are no barriers as to regulations/standards.

3.3.2.13. Open questions and future research work to be done

N/A

3.3.2.14. References

Morris, F., J. E. Braun, and S. J. Tread. 1994. Experimental and simulated performance of optimal control of building thermal storage. ASHRAE Transactions 100(1): 402-414.

Togari, S., Y. Arai, and K. Miura. 1991. Simplified prediction model of vertical air temperature distribution in a large space. Journal of Architectural, Planning, Environment and Engineering, AIJ, No.427, pp9-19 (in Japanese).

3.4. Example of specific calculation methodologies and control strategies to analyse and control buildings making use of TMA

3.4.1 The “dynamic thermal networks” an analysis tool

3.4.1.1 Introduction

Dynamic thermal network is a theory that aims to increase insight into the factors that influence dynamic heat losses in buildings which depends on the building's construction and materials. Today the theory has been programmed into a calculation tool mainly aimed for researchers. With the tool it is easy to compare thermal behaviour and thermal mass benefits for different building components and their materials and constructions. The intention is to further develop the methodology to make it a simple, illustrative and exact design tool for engineers.

Energy balance models for buildings (in a broad sense) involve heat conduction in solid parts (walls, roof, foundation and surrounding ground etc.) coupled to ventilation, heating system, solar radiation etc. The thermal processes in the solid parts depend on preceding conditions. There is a memory effect with characteristic time scales from a few hours for a light wall to many years for the ground below the foundation. Ventilation and radiation are more or less instantaneous, while the heating system may have a characteristic time scale up to an hour. A problem is to address these quite different thermal processes in a coherent way in modeling and automatic control. Time-dependent, multidimensional heat conduction in solid regions involves both advanced mathematical techniques, and numerical and computational skill. There is a need to develop tools of analysis that are as easy to grasp as possible without losing a necessary level of accuracy.

A new methodology called *dynamic thermal networks* is being developed by J Claesson (Claesson 2002 and 2003) at the Department of Building Physics at Chalmers. The relations between boundary heat fluxes and boundary temperatures for any time-dependent heat conduction process in a solid material are represented in the same way as for an ordinary thermal network (for steady-state heat conduction). The thermal conductances between the boundary surfaces are unchanged, but a new *absorptive* component has to be introduced at each node or surface. The memory effect is accounted for by the use of certain averages of preceding boundary temperatures.

The methodology has a conceptual simplicity that should make it easy to implement in energy balance modeling. The time-dependent or *dynamic* components for heat conduction in the solid parts are simply added to the ordinary network for ventilation, heating system etc. The problem of the very different time scales for different components may be addressed in a coherent way.

The method requires that the heat fluxes through the surfaces are calculated for a unit step change at one surface while keeping zero temperature at the other surfaces. The relations between surface temperatures and heat flows for any time-dependent process are obtained by

superposition of the basic step responses. This means that step-response flows contain *all information* required for any particular case.

3.4.1.2. Dynamic thermal networks

We consider heat conduction in a solid volume with two boundary surfaces with the temperatures $T_1(t)$ and $T_2(t)$, respectively. An example is the thermal envelope of a building with roof, walls, foundation and surrounding ground between indoor and outdoor boundary temperatures. The theory, which is briefly presented here without any derivations, is discussed in more detail in Claesson (2002 and 2003).

3.4.1.2.1 Basic relations

The time-dependent or *dynamic* relations between boundary heat fluxes and boundary (air) temperatures may be written in the following way:

$$Q_1(t) = K_1 \cdot [T_1(t) - \bar{T}_{1a}(t)] + K_{12} \cdot [\bar{T}_{1t}(t) - \bar{T}_{2t}(t)] \quad (1)$$

$$Q_2(t) = K_2 \cdot [T_2(t) - \bar{T}_{2a}(t)] + K_{12} \cdot [\bar{T}_{2t}(t) - \bar{T}_{1t}(t)] \quad (2)$$

Here, K_{12} (W/K) is the (steady-state) thermal conductance between the two surfaces. The factor K_1 (W/K) is the *surface thermal conductance* for surface 1. It is equal to the surface area times the heat transfer coefficient between air and solid surface. The conductances are multiplied by temperature differences involving the boundary temperatures at the considered time t and at preceding times $t - \tau$, $\tau > 0$, as described below.

The second right-hand term in (1)-(2) is the same except for the sign. It may be called the *transmittive* heat flux between the surfaces. The first right-hand term may be called the *absorptive* heat flux for surface 1 and surface 2, respectively. This separation of the dynamic boundary fluxes $Q_1(t)$ and $Q_2(t)$ into an absorptive component for each surface and a common transmittive component is quite intricate. It is discussed further in Claesson (2003). The basic relations (1)-(2) are represented graphically as a *dynamic thermal network* in Figure 3.1.

3.4.1.2.2 Transmittive and absorptive average preceding temperatures

In (1)-(2), we use mean values of boundary temperatures backward in time, which are indicated by a bar: \bar{T} . The transmittive mean temperatures for the two boundary temperatures are

$$\bar{T}_{1t}(t) = \int_0^{\infty} \kappa_{12}(\tau) \cdot T_1(t - \tau) d\tau \quad \bar{T}_{2t}(t) = \int_0^{\infty} \kappa_{12}(\tau) \cdot T_2(t - \tau) d\tau \quad (3)$$

Here, $\kappa_{12}(\tau)$ is the transmittive weighting function defined below. There is an absorptive weighting function for each boundary surface and a corresponding absorptive mean temperature:

$$\bar{T}_{1a}(t) = \int_0^{\infty} \kappa_{1a}(\tau) \cdot T_1(t-\tau) d\tau \quad \bar{T}_{2a}(t) = \int_0^{\infty} \kappa_{2a}(\tau) \cdot T_2(t-\tau) d\tau \quad (4)$$

The integrals are extended backwards in time, until the weighting function is sufficiently small so that the rest of the integral (to infinity) is negligible. These backward integrals become sums in the discrete formulation. In the graphical representation of Figure 3.3.1, these backward averages are indicated by summation signs Σ .

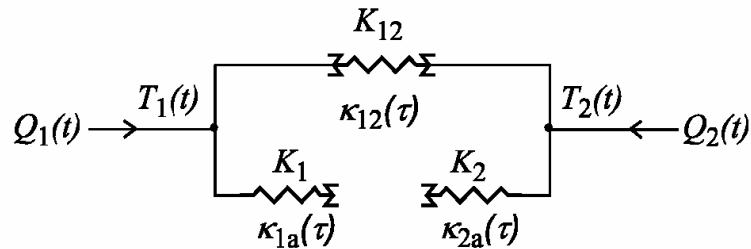

Figure 3.3.1 Dynamic thermal network to represent the relations (1)-(2).

The transmittive component is represented by the conventional resistance symbol with the thermal conductance K_{12} written above component. To the resistance or conductance symbol, we add summation signs on both sides. The signs signify that we take an average of the node temperatures backwards in time according to (3). The left-hand summation sign is reversed to indicate the symmetric character of the flux and that summation concerns the values at the left-hand node. The weighting function $\kappa_{12}(\tau)$ may be written below the resistance symbol.

The two absorptive components are represented by resistance signs with the surface thermal conductance (K_1 and K_2) written above. A summation sign is added at the *free* end after the surface conductance to indicate averages backwards in time according to (4). There is not any summation sign on the node side since the *present* node temperature $T_1(t)$ is to be used at this side in accordance with the first left-hand terms of (1) and (2).

3.4.1.2.3 Step-response heat fluxes

The weighting functions are derivatives of certain basic step-response heat fluxes as described below. There are two step-response problems with a unit temperature step at surface 1 and 2, respectively. We use τ and not t as time variable in the step-response problems. Then the weighting functions have τ as independent variable, while the backward temperatures are taken for $t - \tau$. In the first step-response problem, the temperature outside surface 1 is raised from 0 to 1 at zero time and kept at this value for $\tau > 0$. All temperatures are zero for $\tau < 0$. There is an *admittive* heat flux $Q_{11}(\tau)$ into surface 1 and a cross flux or transmittive flux $Q_{12}(\tau)$ out through surface 2. The corresponding step-response fluxes for a step at surface 2 are $Q_{22}(\tau)$ and $Q_{21}(\tau)$. The cross fluxes are equal due to a general symmetry principle. We have three basic step-response fluxes:

$$Q_{11}(\tau) \quad Q_{22}(\tau) \quad Q_{21}(\tau) = Q_{12}(\tau) \quad (5)$$

The general character of the two admittive fluxes and the transmittive flux are shown in Figure 3.2. They all approach the steady-state flux K_{12} as τ tends to infinity. The admittive fluxes start from the surfaces conductances K_1 and K_2 , respectively, and decrease to the steady-state value. The transmittive flux starts from zero and increases steadily to steady state.

The absorptive step-response fluxes for the two unit steps are given by the absorbed heat, i.e. the difference between the admittive and transmittive fluxes. We have

$$Q_{1a}(\tau) = Q_{11}(\tau) - Q_{12}(\tau) \quad Q_{2a}(\tau) = Q_{22}(\tau) - Q_{21}(\tau) \quad (6)$$

These two fluxes start from the surface conductance and decrease steadily to zero for large time as shown in Figure 3.40.

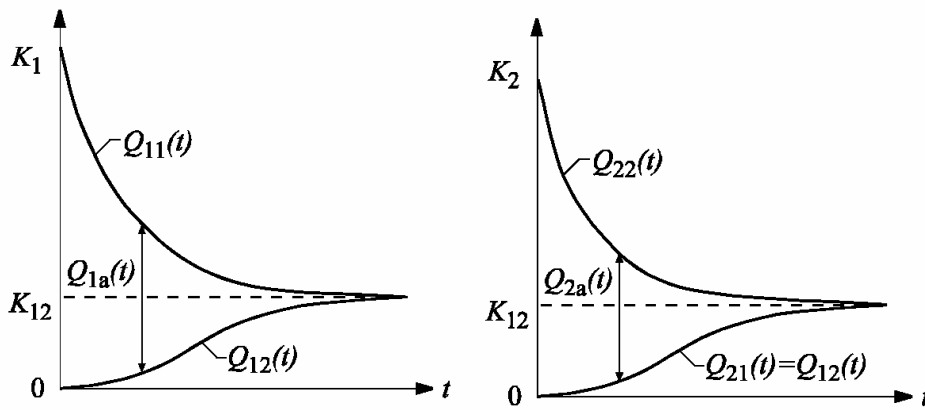

Figure 3.40 Character of the basic step-response heat fluxes.

3.4.1.2.4 Weighting functions

The weighting functions are time derivatives of the step-response functions. The transmittive weighting function, $\kappa_{12}(\tau)$, is the derivative of $Q_{12}(\tau)$ multiplied by $1/K_{12}$, so that the integral (9) becomes equal to 1. We have

$$\kappa_{12}(\tau) = \frac{1}{K_{12}} \cdot \frac{dQ_{12}}{d\tau} \quad (7)$$

The adsorptive weighting function, $\kappa_{1a}(\tau)$, is given by the factor $-1/K_1$ multiplied by the time derivate of $Q_{1a}(\tau)$. We have for the two absorptive weighting functions:

$$\kappa_{1a}(\tau) = \frac{-1}{K_1} \cdot \frac{dQ_{1a}}{d\tau} \quad \kappa_{2a}(\tau) = \frac{-1}{K_2} \cdot \frac{dQ_{2a}}{d\tau} \quad (8)$$

The weighting functions of a concrete building is shown in Figure 3.3.4 and 3.3.5. They are all nonnegative, and the integrals are all equal to 1 due to the factor involving a conductivity factor:

$$\int_0^{\infty} \kappa_I(\tau) = 1, \quad \kappa_I(\tau) \geq 0, \quad I = 12, 1a, 2a. \quad (9)$$

The transmittive weighting functions have a bell-shaped form, Figure 3.42. They are zero during a first period (around an hour) until the temperature step is felt at the other side. They increase to a maximum at a certain time, and then they slowly decrease to zero for large time. The absorptive weighting functions decrease monotonously from a very high value, Figure 3.43.

All equations in this brief outline of the theory of dynamic thermal networks are mathematically exact, or as exact as the numerically calculated step-response functions and their derivatives, the weighting functions. The heat flow problem must be linear so that superposition is applicable.

The heat flow problems considered above have two boundary surfaces with different temperatures. The heat flow problem may in a more general case have N boundary surfaces with different temperatures. Then the dynamic thermal network has N nodes. Each node or boundary surface has an absorptive component. There are transmittive components between all pairs of nodes just as in the corresponding steady-state network. See Claesson (2003). The theory may also be applied for a subsurface of the indoor area. An example is Wentzel (2003), where the heat loss dynamics of different parts of the floor is analyzed. Another application for composite walls is presented in Wentzel and Claesson (2003), where the analyses are extended to the annual heating cost for a variable energy price.

3.4.1.3. An example

By using the theory of dynamic thermal networks to calculate a buildings heat loss, we get a lot of information of its thermal behaviour. The response and weighting functions that is used in the theory involves information about the buildings thermal memory. A buildings thermal memory depends on its construction and materials. Analysis of a buildings response and weighting functions gives among other things information about energy benefits from thermal mass. The method can with advantage be used to design and illustrate energy benefits for different building constructions with different materials. Below, an example of a concrete house is shown. The thermal behaviour are analysed and benefits from thermal mass is discussed.

3.4.1.4.3.1 Studied building

The studied building has a floor area of $8 \times 12.5 = 100 \text{ m}^2$ and an interior height of 2.4 m. The total window area is 17.6 m^2 . Figure 3.3 shows the details of the building. The ground consists of clay. The building's total thermal conductance K_{12} through the floor, ceiling and walls is 55.5 K/W .

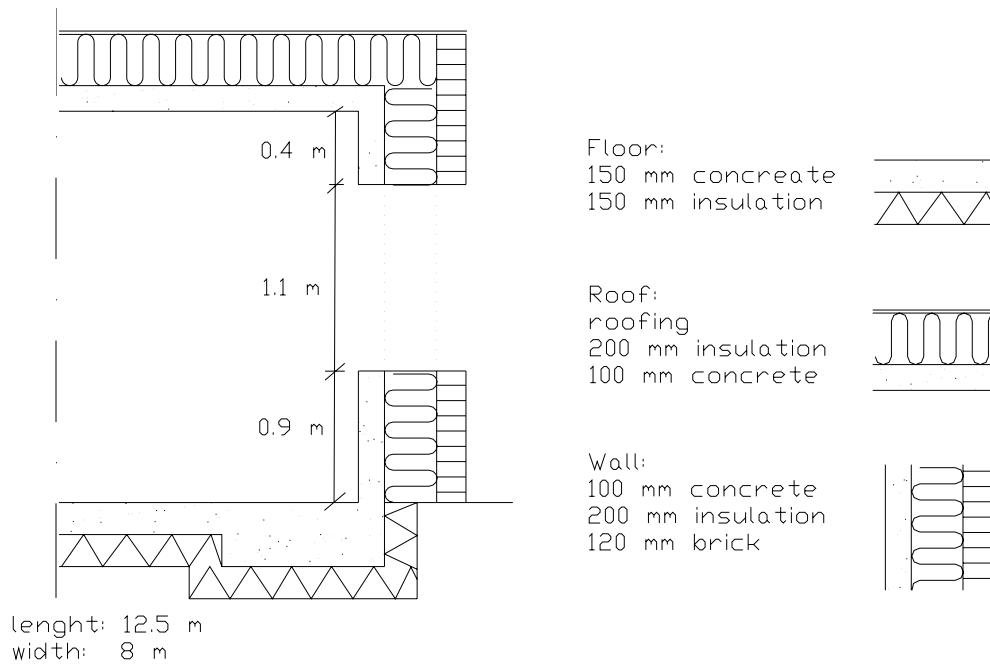

Figure 3.41 Details of the studied building.

3.4.1.4.3.2 Response and weighting functions

The buildings response and weighting functions are calculated with a combination of analytical and numerical solutions, Wentzel (2005). The response calculations are made for three dimension heat follow in a very exact way.

3.4.1.4.3.3 Transmittive response and weighting function

Figure 3.3.4 shows the transmittive response function and the corresponding weighting function. The time axis is shown in log-scale in order to represent both the long tail and the first period in a single diagram. The time axis covers an interval from 0.1 hour to $1 \cdot 10^7$ hours (=1140 years). Both curves are normalized to 1 by division with the total thermal conductance K_{12} and the weighting function's maximum value, $\kappa_{12,\max}$, respectively.

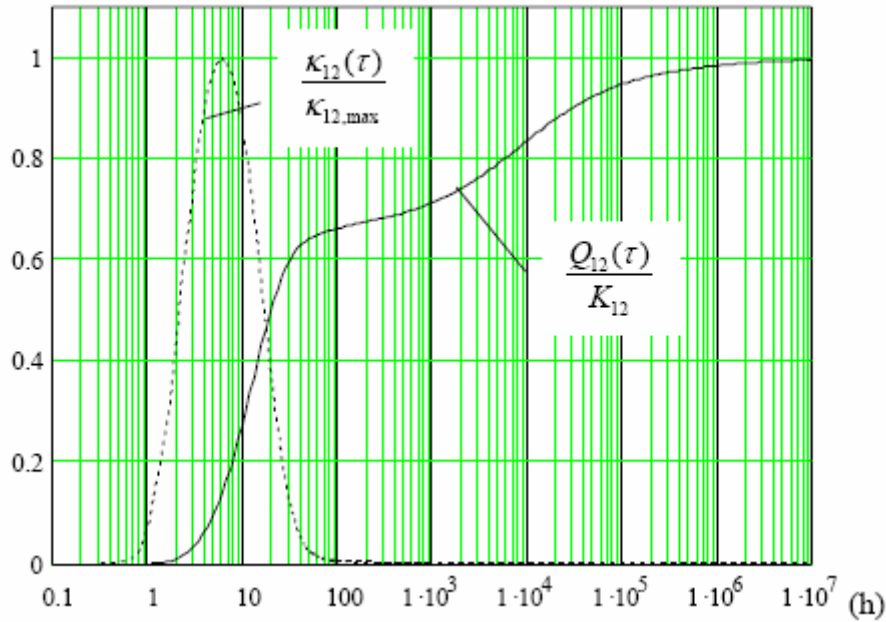

Figure 3.42 The building's transmittive response flux and its weighting function normalized to 1 by K_{12} (55.5 W/K) and $\kappa_{12,max}$, respectively. Time axis in log-scale and hours.

The transmittive response flux is virtually zero before $\tau = 1$ hour. The largest rate of increase of the flux occurs between 2 to 15 hours. This is reflected in the weighting function, which exceeds 40% of its maximum value in this interval. The maximum rate of the response flux, and hence the maximum of the weighting function, occurs for $\tau = 6$ hours.

3.4.1.4.3.4 Absorptive response and weighting function

Figure 3.43 shows the absorptive response function and the corresponding weighting function. The time axis is shown in log-scale in order to properly represent both the long tail and the first period. The time axis covers an interval from 0.001 hour (=3.6 seconds) to $1 \cdot 10^4$ hours (=1.14 year). The absorptive response curve is normalized to one by division with the surface thermal conductance, K_1 (= 2191 W/K). The absorptive weighting function tends to infinity as $1/\sqrt{\tau}$ when τ tends to zero. The absorptive weighting function is here normalized to 1 by division with the value at the smallest time in the figure, i.e. $\tau = 3.6$ s.

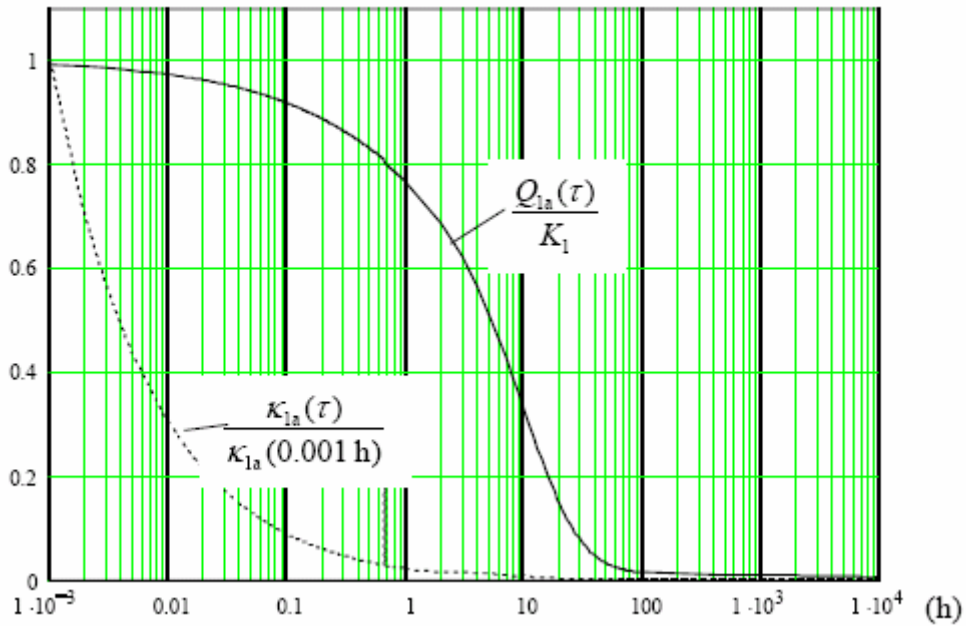

Figure 3.43 The building's absorptive response flux and weighting function normalized to 1 by K_1 and $\kappa_{1a}(0.001 h)$, respectively. Time axis in log-scale and hours.

3.4.1.4.3.5 Thermal behaviour and average preceding temperatures

The buildings transmittiva and absorptive weighting functions are used to calculate the average preceding temperatures (3) and (4). These temperatures tell us about how the building experience temperature variations both on the inside and on the outside. These temperatures have vital importance of the buildings heat loss.

Figure 3.44 shows the values of the transmittive average outdoor temperature for January (left) and July (right). The thick line represents the average temperature and the thin line the real outdoor temperature for Gothenburg climate in Sweden. We see that the average temperatures are smoothed as compared to the outdoor temperature, a few degrees warmer during winter and a few degrees cooler during summer.

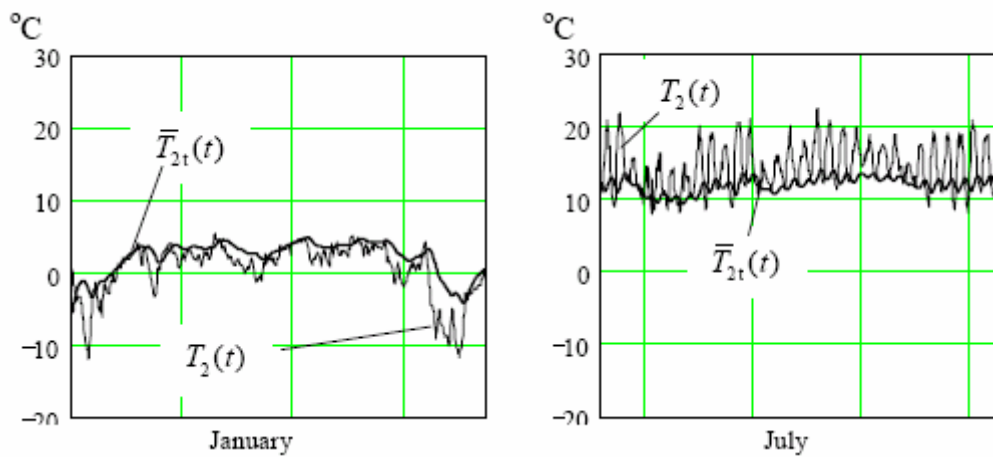

Figure 3.44 Outdoor temperature $T_2(t)$ (thin line) and corresponding transmittive average, $\bar{T}_{2t}(t)$, exhibiting more moderate fluctuations.

Figure 3.45 shows the values of the transmittive average indoor temperature for two days. We assume that the indoor temperature varies as a sinus wave between 23 °C during day and 19 °C during night. The thick line represents the average temperature and the thin line the real indoor temperature. We see that the average temperatures are smoothed and have a time lag of about 8.5 hours as compared to the indoor temperature. This time lag corresponds rather well with the transmittive weighting functions maximum which occurs between 2 and 15 hours.

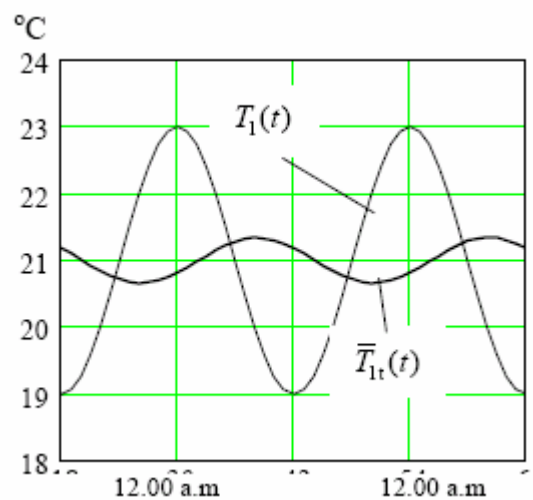

Figure 3.45 Assumed indoor temperature (thin line) and transmittive average indoor temperature (thick line) over 48 hours.

Figure 3.46 shows the values of the absorptive average indoor temperature for two days. The thick line represents the average temperature and the thin line the real indoor temperature. We see that the average temperatures are smoothed and have a time lag of about 4.8 hours as compared to the indoor temperature. This time lag is a good half of the transmittive part.

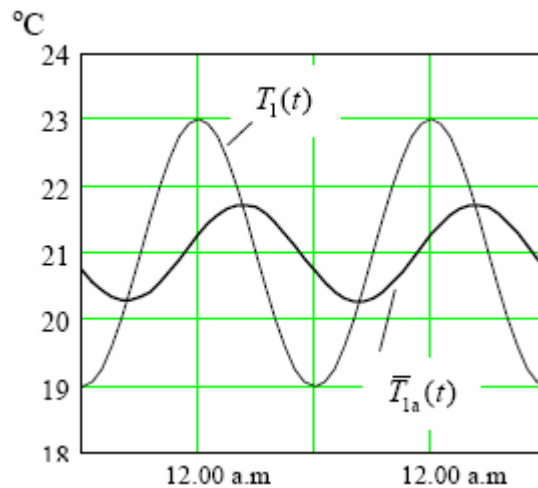

Figure 3.46 Indoor temperature (thin line) and absorptive average indoor temperature (thick line) over 48 hours.

It is interesting to compare the transmittive and absorptive mean values. Figures 3.45 and 3.46 show these for the indoor temperature. There is a decrease in amplitude and a phase lag as compared to the indoor temperature. The amplitude is smaller and the phase lag is larger for the transmittive case than the absorptive case. This is due to the fact that the whole building envelope is involved in the transmittive case. In the absorptive case only a certain region inside the indoor surface is of major importance.

3.4.1.4.3.6 Thermal mass benefits

In this case, with a Nordic outdoor climate and an indoor temperature that varies between a high and a low value, the benefits from thermal mass are represented in the absorptive average indoor temperature. The absorptive heat loss is the difference between the two temperature curves in Figure 3.8. When the indoor temperature $T_1(t)$ is high, heat is stored in to the building and when the average temperature $\bar{T}_{1a}(t)$ is high, heat is brought back to the inside. The more smoothed and the longer time lag of the absorptive average temperature the more heat may be stored and regained to the building.

In Figure 3.3.9, the absorptive average temperature for the above studied concrete building (thick solid line) is compared with corresponding temperature for a “lighter” building (dashed line), for example a building with a gypsum board and insulation on the inside. The thin line is the real indoor temperature. We see that the difference between the indoor temperature and the absorptive average temperature for the light building is lesser then for the concrete building. That means less heat is stored and regained in the light building.

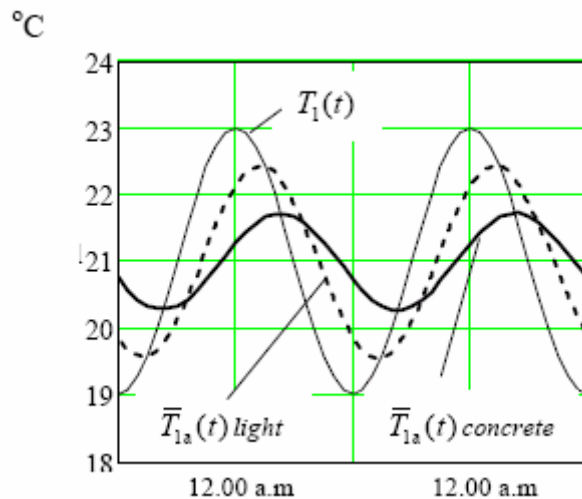

Figure 3.47 The absorptive average indoor temperature for the concrete building (thick line) is compared with the absorptive average indoor temperature for a “light” building (dashed line). The thin line is the real indoor temperature.

By studying different buildings response and weighting functions we may form an opinion of its thermal behaviour and get a view of thermal mass benefits. This can be done without complicated energy balance calculations.

3.4.1.4. Conclusions

Dynamic thermal networks is a theory that was developed to increase insight into the factors that influence a dynamic heat loss calculation, such as material choose and whole building designs. Another purpose of the methodology is to provide a handy and illustrative tool to analyse different thermal behaviour of buildings with heat loss in one-, two- and three-dimensions. The theory is based on step-response functions. The relations between boundary heat fluxes and boundary temperatures for any time-dependent heat conduction process in a solid material are represented in the same way as for an ordinary thermal network (for steady-state heat conduction). The thermal conductances between the boundary surfaces are unchanged, but a new *absorptive* component has to be introduced at each node or surface, see Figure 3.1. The memory effect is accounted for by the use of certain averages of preceding boundary temperatures.

To day dynamic thermal networks is a scientist tool, but the intention is to further develop the methodology to make it a simple, illustrative and exact design tool for engineers. The theory may with advantage be used to analyse how thermal mass and its arrangement influence a buildings heat loss. The theory also makes it easy to compare thermal behaviour and thermal mass benefits for different materials and constructions in a fast and simple way.

The thermal behaviour is determined and illustrated by the shape of response or weighting functions. These functions have been analysed for a concrete building. Average preceding temperatures for both the transmittive and absorptive heat loss has been obtained and analysed. The absorptive average of the indoor temperature reflects the benefits from thermal mass. In the case of a Nordic climate and an indoor temperature which varies between day

and night, we obtain most thermal benefits if the absorptive average indoor temperature $\bar{T}_{ia}(t)$ is smoothed and have a big time lag compared to the real indoor temperature, a building with thermal mass on the inside gives such behaviour.

3.4.1.5. References

Claesson J. (2002). Dynamic Thermal Networks. Background studies I: Elements of a mathematical theory of thermal responses. Report, Dept. of Building Physics, Chalmers Technical University, Gothenburg, Sweden.

Claesson J. (2003). Dynamic thermal networks: a methodology to account for time-dependent heat conduction, Proceedings of the 2nd International Conference on Research in Building Physics, Leuven, Belgium, p. 407-415. ISBN 90 5809 565 7

Wentzel E-L (2003). Application of the Theory of Dynamic Thermal Networks for Energy balances of a Building with Three-dimension Heat Conduction. Proceedings of the 2nd International Conference on Research in Building Physics, Leuven, Belgium, p. 625-632. ISBN 90 5809 565 7

Wentzel E-L. Claesson J. (2003). Heat Loss Dynamics of Walls. Analysis and Optimizing Based on the Theory of Dynamic Thermal Networks. Proceedings of the 2nd International Conference on Research in Building Physics, Leuven, Belgium, p. 397-405. ISBN 90 5809 565 7

Wentzel E-L. (2005). Thermal Modeling of Walls, Foundations and Whole Building Using Dynamic Thermal Networks. Doctoral thesis, Chalmers University of Technology, Gothenburg Sweden. ISBN 91-7291-686-9

3.4.2 A weather forecast control strategy for using thermal behaviour benefits in building components

3.4.2.1. Introduction

Control system based on weather forecast seems a promising tool to make more possibilities to use thermal behaviour benefits in building components. With weather forecast control the passive thermal mass in building components actively can be used to reduce energy consumption at the same time as fluctuations in the indoor temperature is avoided.

Traditional building control and regulation systems only take consideration to the current situation rather than to that which will occur in the near future. In practice, this means that most buildings' heating and cooling systems are regulated by the current outdoor (or sometimes indoor) temperature alone.

With weather forecast control the thermal mass in building components actively can be used to reduce energy consumption at the same time as fluctuations in the indoor temperature is avoided. Whether forecast control considers several external factors, such as temperature, sunshine, wind strength and direction - and the control system receives this information in advance.

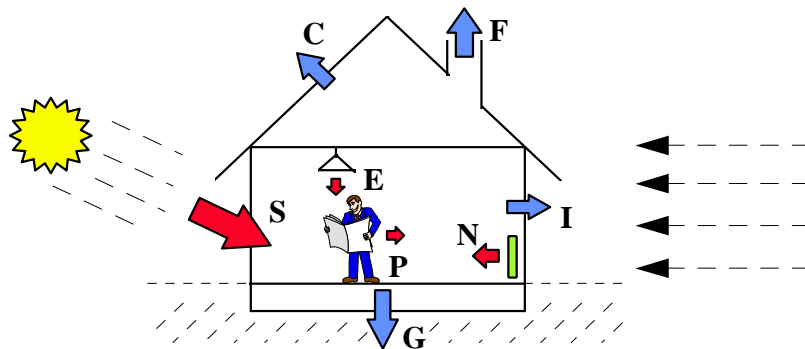

Figure 3.48 External factors in weather forecast control

Weather forecast control is based on utilizing the thermal activated mass in the building's components as walls, roofs, furniture etc. If one knows in advance that a cold night will be followed by a warm and sunny day, the thermal mass in the building's components can become an advantage. Heating can then be reduced several hours in advance without the indoor temperature having time to fall. And vice versa – when windy and overcast weather is on the way, heating can be increased in advance.

Thus one attains a balancing of the energy supply and a more stable indoor climate. This results in reduced energy consumption. Furthermore, the more stable indoor climate often is positively received by the occupants.

With Weather forecast control the outdoor climate parameters (temperature, sunshine, wind), together with data on the building's characteristics pertaining to position, orientation, properties and method of use are put into a algorithm that results in what is referred to as

equivalent temperature (ET). The equivalent temperature value replaces the outdoor temperature signal into the heating regulator.

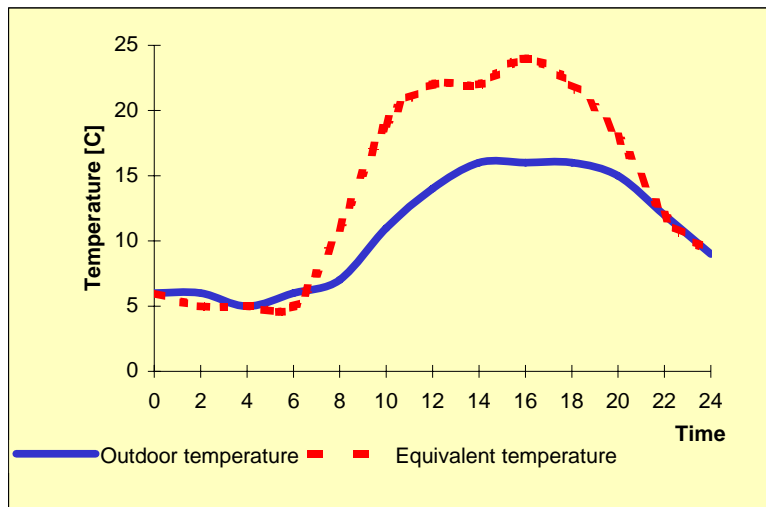

Figure 3.49 Comparison of outdoor or equivalent temperature during one day

3.4.2.2. Example of application

Honeywell in Sweden has developed a weather forecast prognosis receiver for existing control systems in buildings called WeatherGain. The forecast is delivered by the Swedish Meteorological and Hydrological Institute (SMHI). When the WeatherGain function is in use, new prognosis data for the equivalent temperature normally are sent via the Internet daily and each prognosis is for 5 days. This system has been used in several buildings in Sweden.

However, like in a building equipped with a heating system controlled based on only the outdoor temperature (central feed-forward control), also when Weather forecast control is in use the indoor temperature sometimes can become too high in single office rooms. This is due to the fact that the internal heat loads, as well as the solar radiation heat, can differ from room to room. When a Weather forecast control system is to be put into operation attention is paid to the internal heat loads (lighting, people, office machines etc.) in the whole building – but can normally not consider differences between different parts of the building.

3.4.2.3. References

Uppström, R.; Pihl, I.; Fridén, L.; Gillqvist, T.: Control Strategies. Report of the EU-Energie project "IDEEB". Report IDEEB No. 07, ISBN 91-85303-28-3, SP Swedish National Testing and Research Institute, December 2004.

Chapter 4 Earth-to-Air Heat Exchanger and Earth Coupling (EC)

4.1. Component description and examples of existing applications

An Earth-to-Air Heat Exchanger (ETAHE) ventilates air to the indoor environment through one or several horizontally buried ducts. In this way, the ground's large thermal capacity and relatively stable temperatures are used to preheat or pre-cool the air, resulting in energy savings for the building. An ETAHE can be applied in either an open-loop or a closed-loop form. Figure 1 is an open-loop system, in which the inlet is exposed to ambient air. A closed-loop system is usually used in greenhouses, livestock houses and buildings with a separate fresh air source. In buildings with desired indoor temperatures from 20°C to 25°C, ETAHEs are primarily used for cooling purposes since soil temperatures are usually below this temperature all the time. ETAHEs can also be used for winter heating when the outdoor air temperature is lower than that of the soil, but additional heating systems are usually needed.

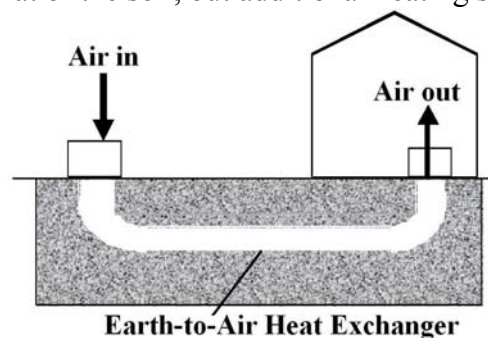

Figure 4.1. Building with an Earth-to-Air Heat Exchanger

The ETAHE technology has been applied in different types of buildings. Various names have been used, such as Earth Cooling Tube, Ground Coupled Air System, Cool-Tube in-Earth Heat Exchanger, Earth Air Tunnel, Earth Contact Cooling Tube, Earth Tube Heat Exchanger, Buried Pipe Cooling System, Underground Solar Airheater, Earth Air-Pipes System, Air-Soil Heat Exchanger, Embedded Duct, Earth Channel, Hypocaust, and Earth-to-Air Heat Exchanger. The name Earth-to-Air Heat Exchanger is adopted here because it is relatively common and it represents the principle of the technology without limiting its physical configurations.

Most existing ETAHE systems are installed in mechanically ventilated buildings, in which electrical fans provide the airflow driving forces. In such systems, an ETAHE can be a single duct or a number of parallel ducts made of prefabricated metal, PVC, or concrete pipes with diameters between 15 cm to 40 cm. The typical arrangements for the ducts are as follows:

- Laying the piping in ditches in the surrounding yard
- Laying the piping in the foundation ditch around the building
- Parallel piping directly under the foundation or between the single and continuous strip foundation

In case of the parallel pipe systems, the distance between the pipes should be approximately 1.0 meter. If the pipes are placed very close to each other, the interaction between the pipes

can reduce the system efficiency. Greater spacing does not bring extra benefit (Zimmermann and Remund 2001). The size of an ETAHE depends on the designed airflow rate and the available space. Applying a smaller system to improve comfort in housings could be relatively inexpensive. The inlet and outlet of the ETAHE can be established with simple standard components especially for smaller systems. The size is designed according to the airflow rate and a maximum air velocity of 2 m/s is recommended for smaller systems (larger systems can be designed for air velocities up to 5 m/s).

Recently, to reduce the airflow resistance in an ETAHE as well as the related fan energy consumption, some hybrid ventilated buildings have adopted very large cross-sectional ducts. Schild (2001) overviewed 12 such systems, and two of them, namely Mediå School and Jaer School, will be described later. The integration of ETAHE and hybrid ventilation is regarded as a new approach to improving building energy efficiency (Heiselberg 2004).

4.2 Example of applications

4.2.1. Schwerzenbacherhof building, Zurich, Switzerland

4.2.1.1. General information

The Schwerzenbacherhof building is a commercial building near Zurich, Switzerland, with a heating energy consumption of 144 MJ/m² per year for 8050 m² of heated surface. It was a major case study in the IEA-ECBCS Annex 28 (Low Energy Cooling). Information about this building is from several Annex 28 publications (Zimmermann and Remund 2001, Liddament 2000, and Zimmermann 1995) and from studies conducted by Hollmuller (2002) and Hollmuller and Lachal (2005). Figure 4.2 is a picture of the building with its ETAHE's inlet. There are two paths for the building to intake fresh air. The air can either pass through the ETAHE system under the building or bypass it to air handling units, as shown in Figure 4.3.



Figure 4.2. Schwerzenbacherhof building

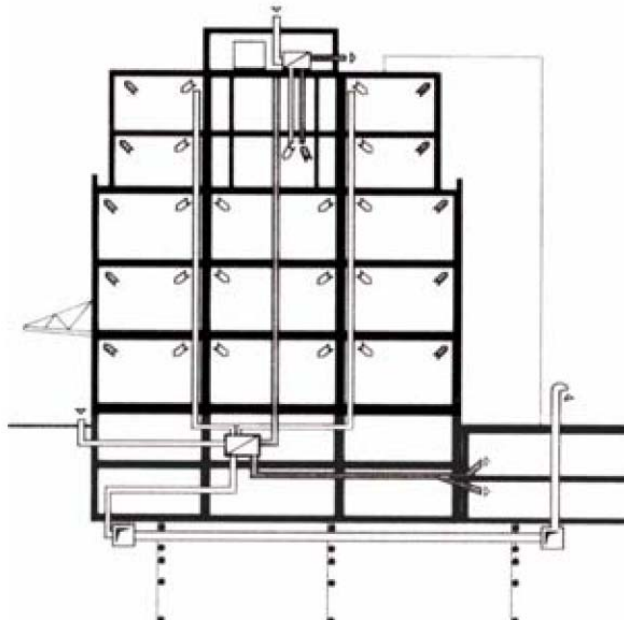

Figure 4.3. Schematic of Schwerzenbacherhof building ventilation system (Hollmuller and Lachal 2005).

4.2.1.2. Component description

The ETAHE is 6 m beneath the ground surface, which is below the ground water level and 75 cm below the building's second basement (unheated) where is below the ground water level. As seen in Figure 4.4 (left), it consists of 43 parallel high-density polyethylene pipes with a one percent incline. Each pipe has a length of 23 m and a diameter of 23 cm. The mean axial distance between two pipes is 116 cm. Two large concrete ducts were built on-site before and after the pipe system to distribute and collect the air. Drainage to sewage is provided in the intake-side concrete duct (see Figure 4.4 , right). A varying airflow rate during office hours (12,000 m³/h in winter and 18,000 m³/h in summer) is kept by two fans in the system (see Figure 4.5).

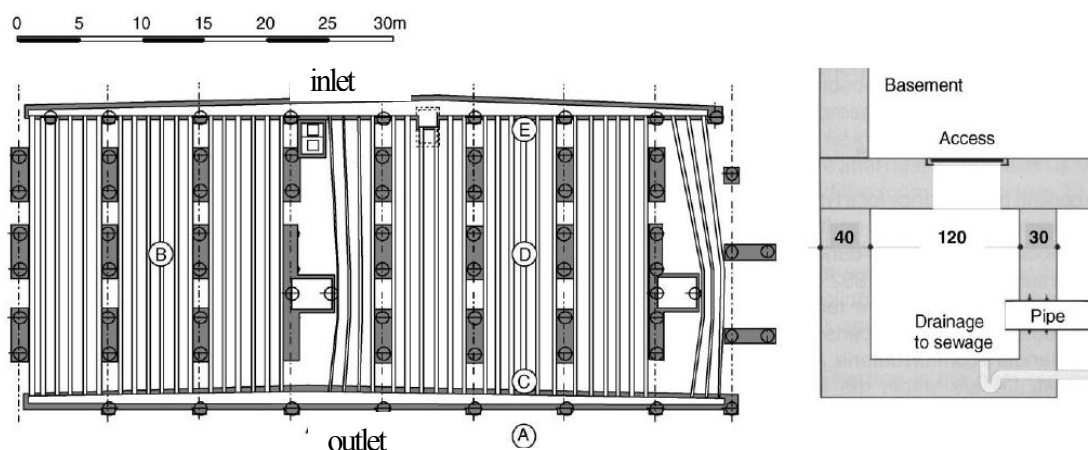

Figure 4.4. General layout and construction detail of the ETAHE system in Schwerzenbacherhof building (Hollmuller 2002)

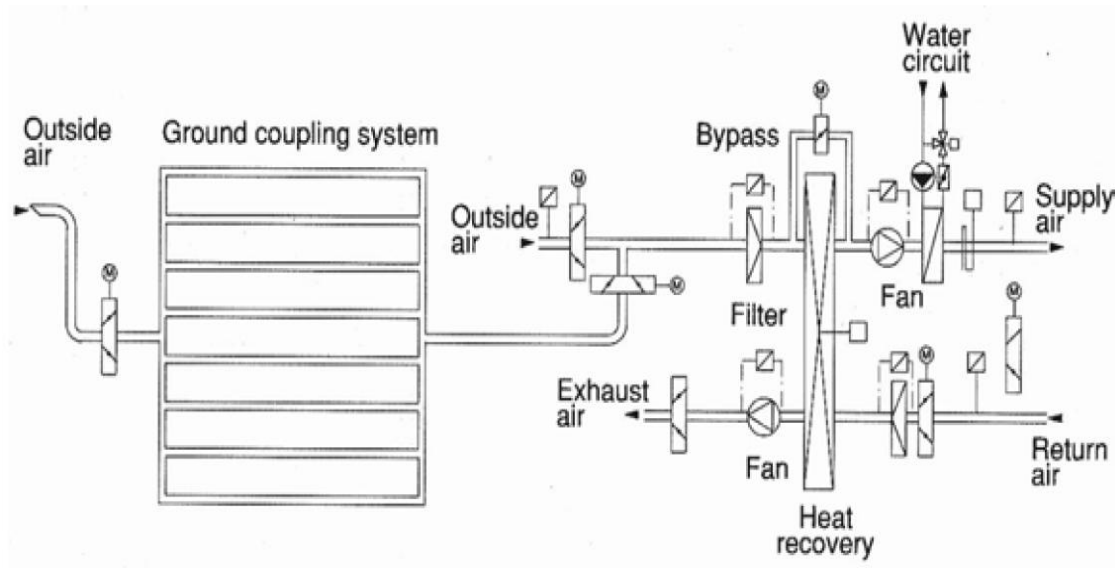

Figure 4.5. Ventilation system's components of Schwerzenbacherhof building (Hollmuller 2002).

4.2.1.3. Control strategy

The ETAHE system is activated in summers when the outdoor air temperature exceeds 22°C. The air is cooled down as it passes through the pipes, and then it is directly supplied to the rooms. When the outdoor temperature is lower than 22°C, the air bypasses the ETAHE and is taken in directly from outside. This normally happens at night-time. The ETAHE provides about 1/3 of total cooling, and the rest is provided by night cooling of the thermal mass. Thus the ETAHE is only a supplement (mainly during the daytime) when night cooling is insufficient.

In winters, when the ambient temperature falls below 7°C, the ETAHE starts to be used to provide preheating. Then the outlet air from ETAHE passes through the heat recovery unit, which transfers heat from the exhaust air to the outlet air. This also helps to cool the ground for the next summer and to prevent freezing of the heat recovery unit.

4.2.2. Mediå School, Grong, Norway

4.2.2.1. General information

Mediå school is a 1001 m² one-floor building located in Grong, Norway. It was one of the case studies in the IEA-ECBCS Annex 35, Control Strategies for Hybrid Ventilation in New and Retrofitted Office Buildings (HybVent). It was investigated by Tjelflaat (2000a and 2000b) and Wachenfeldt (2003). The building's layout and the schematic of the ventilation system are respectively shown in Figures 4.6 and 4.7.

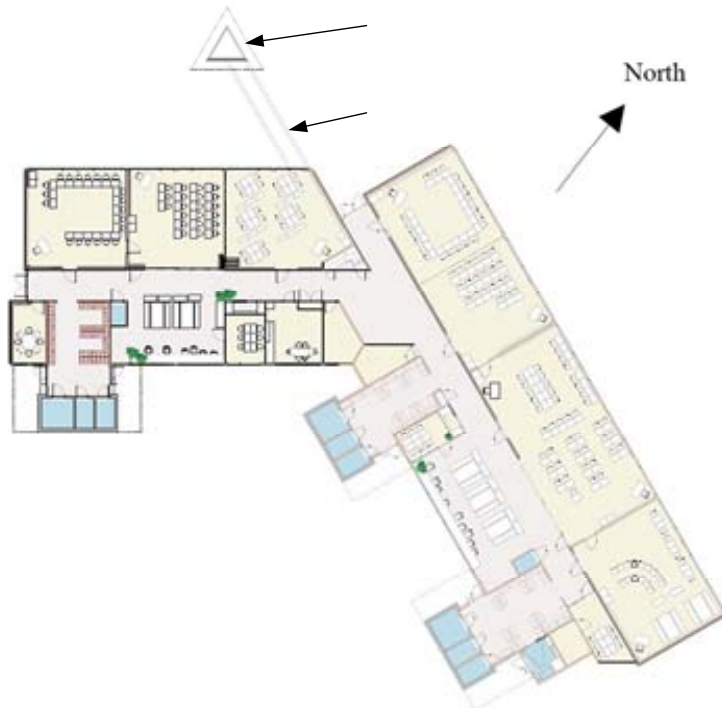

Figure 4.6. Mediå school layout (Tjelflaat 2002b)

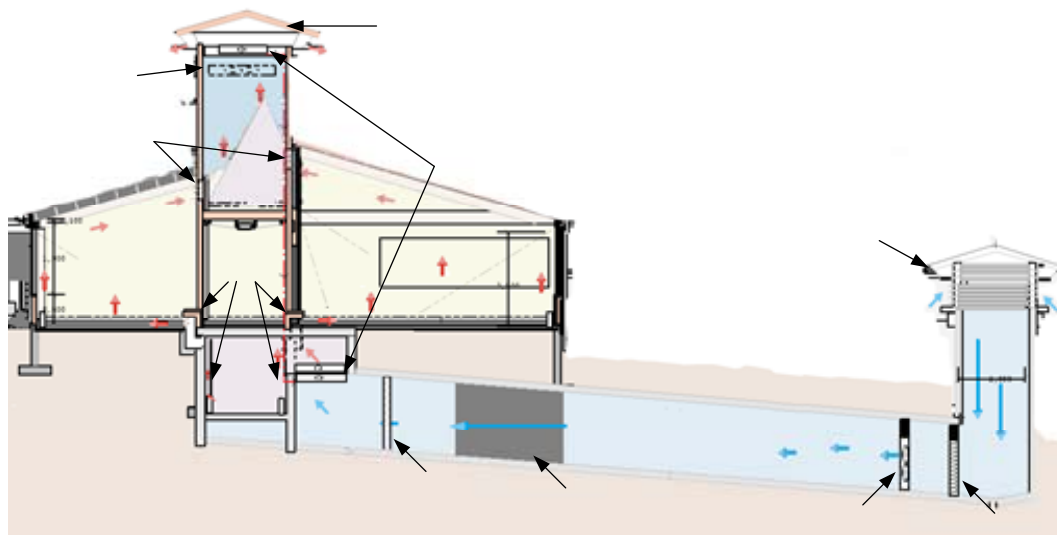

Figure 4.7. Schematic cross section of Mediå school showing air flow paths and location of components 1 = triangular intake tower with openings and vents, 2 = damper, 3 = supply fan, 4 = sound absorber, 5 = filter, 6 = exchangers for supply air preheating using run-round heat recovery via a circulating water-glycol mixture as well as additional reheating, 7 = air distribution duct, 8 = units for noise attenuation plus openings and grilles for supply of ventilation air to the classrooms, 9 = dampers for extracting exhaust ventilation air from the classrooms, 10 = extract fan, 11 = triangular roof tower with exhaust vents. (Tjelflaat 2002a).

4.2.2.2. Component description

An air intake tower for the ETAHE is located north of the building and stands on a 35° slope, as shown in Figure 4.8. The height from the tower's top to its base is approximately 6 m. On each side of the tower there is an opening, which is covered by a metal shield to protect it from precipitation. Behind the shield each opening is equipped with a one way damper allowing air entrance when pressurized.



Figure 4.8. ETAHE's intake tower of Mediå school

After passing through the intake tower, the downward airflow is led to a horizontal 1.5 m × 2 m concrete air intake duct, which is approximately 1.5 m below the earth surface (refer to Figure 4.7). A damper is installed at the beginning of the duct. A frequency-controlled variable-speed propeller fan with a diameter of 1.4 m is located 1.5 m away from the damper on the leeward side. Its operation is interlinked with the damper opening position. A noise absorber is located 6.3 m from the fan. Six fine filter blocks are installed at the end of the duct. The total distance from the damper to the filters is 11.1 m. The duct has a 5% incline to the inlet direction to allow cleaning. Drainage is located at the base of the air intake tower.

After leaving the intake duct, the air vertically passes through two overlapped heat exchangers (see Figure 4.9, left) and enters a 2.2 m × 2 m horizontal air distribution duct. This duct has two branches which are below the building's corridor. The air from the intake duct can also bypass the heat exchangers by flowing through two "summer" doors beside the exchangers. Figure 4.9 (right) shows the distribution duct with the air supply paths attached on the walls to the ground level classrooms. These paths suppress sound transmission between rooms and ensure even supply air temperatures to all rooms.



Figure 4.9. Air distribution duct of Mediå school (Left photo shows heat exchangers and “summer” doors. Right photo shows the supply air paths) (Tjelflaat 2002a).

4.2.2.3. Control strategy

The whole HVAC system is monitored and controlled by a centralized supervisory Building Energy Management System (BEMS) with CO₂ and temperature sensors located in most classrooms. The ETAHE preheats air in winters. The temperature set point in the distribution duct is 19°C. This is ensured by the two heat exchangers at the end of the air intake duct. In summers, the ETAHE is the only cooling component in the system. The supply fan is activated by the BEMS when larger air change rate is needed. When the two heat exchangers are not needed, the bypass doors can be manually opened to reduce the pressure loss.

4.2.3. Jaer School, Oslo, Norway

4.2.3.1. General information

Jaer primary school is an 850 m² two-storey heavyweight building near Oslo, Norway. It was another case study of the IEA-ECBCS Annex 35. A schematic of the building ventilation system is shown in Figures 4.10 and 4.11.

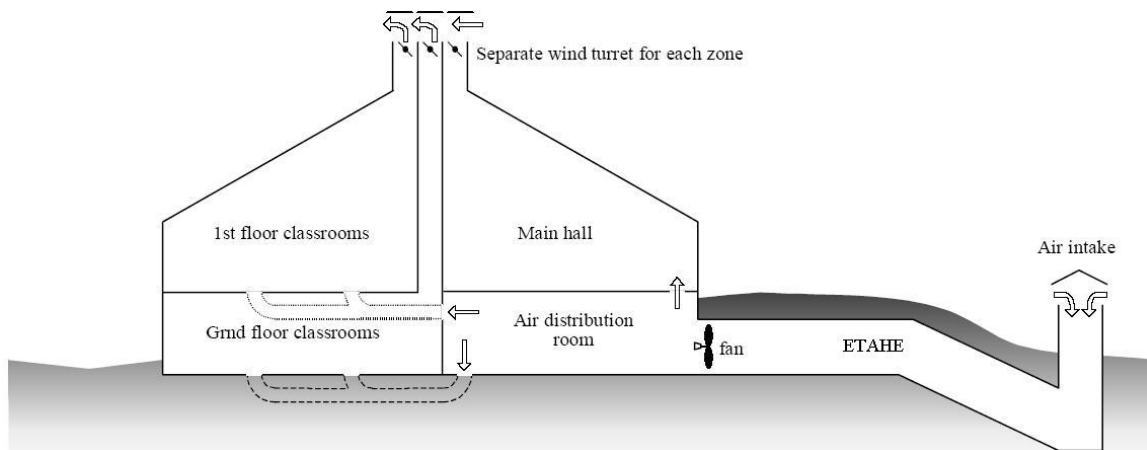

Figure 4.10. Schematic cross section of Jaer School showing air flow paths and components' locations (Schild 2002a).

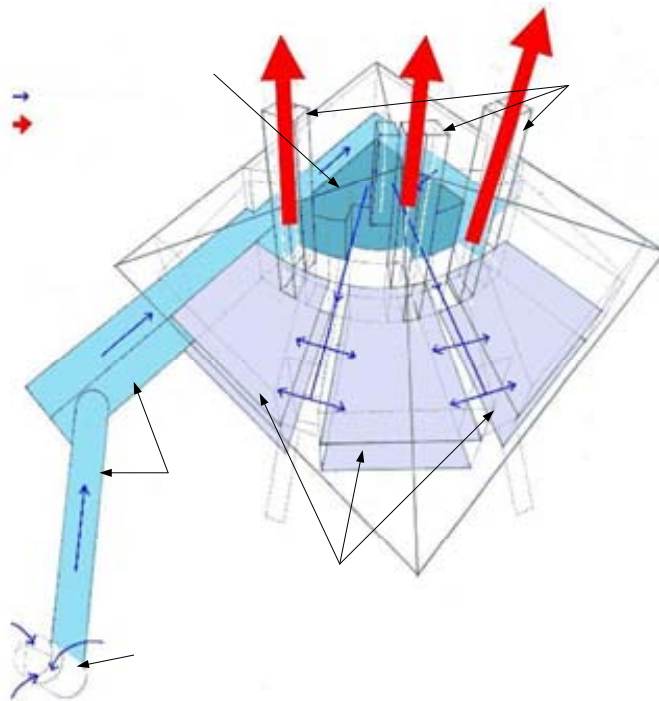

Figure 4.11. 3D schematic of Jaer School ventilation system (Schild 2002a).

4.2.3.2. Component description

The ETAHE's air intake tower, about 2 m above the ground surface, is located outside the building. To minimize the pressure drop, the air intake louvers were made open without rain and snow shielding. A frost-protected drain is provided on the base of the tower (see Figure 12).



Figure 4.12. Jaer School air intake tower (Left: outside, Middle: inside looking up, Right: inside horizontally into base of the tower from the horizontal ETAHE duct.) (Schild 2002a).

The ETAHE consists of two parts: a prefabricated concrete pipe (20 m length and 1.6 m diameter) and a rectangular cast-in-place concrete duct (35 m length, 2 m width, and 3 m height). At the end of the rectangular duct, there are two parallel paths for the fresh air entering the air distribution room. One is to pass a speed controlled fan and the other is to pass a preheat unit as shown in Figure 4.13. This is controlled by a computerized Building Energy Management System. From the distribution room the air is delivered to various rooms through plastic subterranean ducts from the floor level. The hybrid ventilation concept is mainly implemented in the rooms by exploiting buoyancy forces and a wind-assisted exhaust tower on top of the building to ventilate air. When these natural forces are not enough to keep necessary airflow rates, the fan at the end of the ETAHE duct is activated to a proper speed.



Figure 4.13. The air distribution room, showing the preheat unit (left) and fan, as well as the plastic subterranean ducts leading to the various rooms (Schild 2002a).

4.2.3.3. Control strategy

Since the pressure drop through the ventilation system is very small, the stack effect alone in the building has always been enough to satisfy the airflow requirement for the indoor air quality. The fan is only used when additional cooling is needed. When the supply air needs to be heated, the centralized BEMS controls the amount of fresh air passing the preheat unit.

4.3. Working principles

The utilisation of the ground heat storage capacity with the means of an ETAHE depends on the ground composition and the climate at the location.

4.3.1. Heat flows in the Earth

The earth is a steady and practically infinite heat source, sink, and storage medium. From its surface to a hundred-meter depth, the heat transfer processes take place in various forms as shown in Figure 4.14. At the ground surface, heat transfer is mainly caused by short/long wave radiation, evaporation, and convection. Conduction is the main form of heat transfer in the earth except for regions with water movements. Geothermal energy from the layers below the crust (the mantle and core) flows up like a constant heat source. Since an ETAHE operates close to the earth surface, there is little influence from the geothermal parameters.

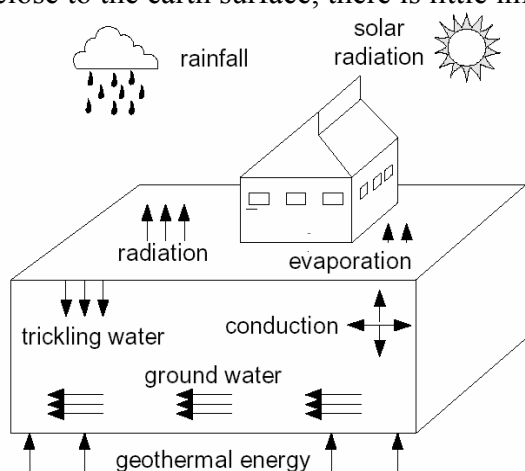

Figure 4.14. Different environmental influences and heat transfer mechanisms for the ground (Wagner et al. 2000)

4.3.2. Ground temperature distribution

The high thermal inertia of soil allows the ground to dampen the oscillation of ambient temperatures. Thus the soil temperatures at a certain depth remain relatively independent of daily variations, but are still affected by seasonal changes. It is known that the earth temperature level beneath a neutral zone, approximately 15 m to 20 m below the ground surface, is constant and rises towards depth. Below the neutral zone, the temperature increase is governed by the upwards geothermal heat flux. Above the neutral zone, climatic changes at the surface govern the temperature development. Figure 4.15 is an example of soil temperature profiles in different depths and time.

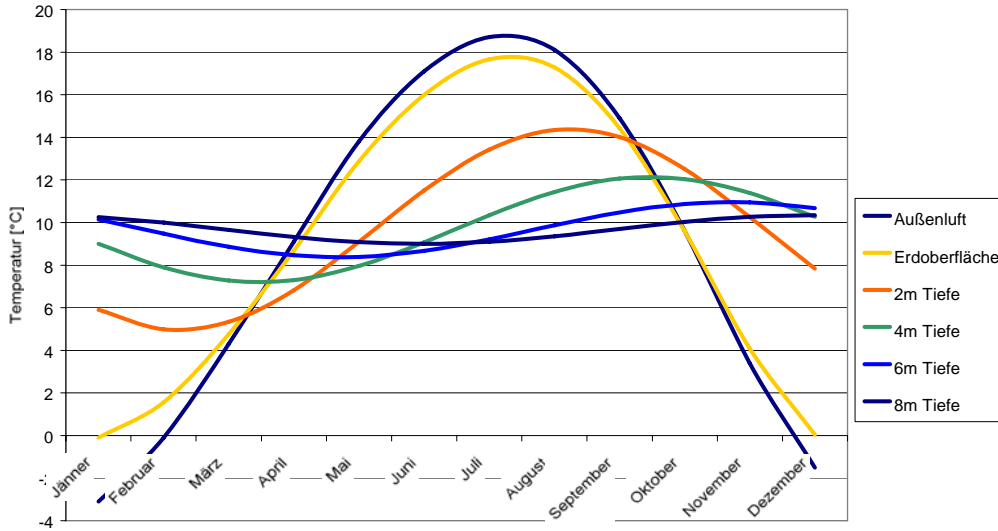

Figure 4.15: Mean yearly temperature progression in the ground at different levels. Annual temperature of outdoor air (“Außenluft”), surface of the ground (“Erdoberfläche”) and soil at different depths (2-8 m) for the soil type “dry pebble stones”. The graph is based on the mean monthly values, location Graz, Austria. (Fink et al. 2002).

As far as soil temperatures are concerned, an ETAHE should be installed as deep as possible since the temperature fluctuations are dampened deeper in the ground. However, the excavation cost for laying an ETAHE very deep may not be economical. In the existing applications, the ETAHE ducts were usually buried 1 to 4 m below the earth surface. In this region, with absence of ETAHEs, the soil temperatures can be predicted by the following undisturbed soil temperature equation, which was developed from heat conduction theory applied to a semi-infinite homogeneous solid by Kusuda and Bean (1983) and Labs (1989).

$$T_s(z, t) = T_{s,m} - A_s \exp\left[-z \left(\frac{\pi}{8760\alpha_s}\right)^{0.5}\right] \cos\left[\frac{2\pi}{8760} \left(t - t_0 - \frac{z}{2} \left(\frac{8760}{\pi\alpha_s}\right)^{0.5}\right)\right] \quad (1)$$

Where,

$T_s(z, t)$ is undisturbed soil temperature (°C) at depth z (m) and time t (hours)

t is time elapsed from the beginning of the calendar year, hours.

$T_{s,m}$ is annual mean soil temperature, °C.

A_s is amplitude of surface temperature variation, °C.

α_s is soil thermal diffusivity, m²/h.

t_0 is a phase constant since the beginning of the year of the lowest average soil surface temperature, hours.

4.3.3. Heat and mass transfer in ETAHE

When outdoor air is drawn into an ETAHE duct, the temperature difference between the air and the duct causes convective heat transfer, which changes the duct temperatures. The resultant temperature gradients from the duct surface to its surrounding soil will further cause

new temperature distributions in the soil. Moisture diffusion takes place as a simultaneous process, which affects the heat transfer to some extent.

The temperature change of air from the inlet to outlet represents a sensible heat variation. When the duct material is moisture-permeable or the duct surface temperature reaches the dew point temperature, latent heat changes may take place through condensation, evaporation, or moisture infiltration. The performance of an ETAHE depends on the sum of the two parts (latent and sensible).

The heat convection, an important factor affecting ETAHE's performance, is mainly dependent on the airflow and the temperature difference between the air and the duct. In conventional ETAHE systems, the pipes' internal surfaces are usually smooth, and their diameters are very small compared to their lengths. In these pipes, the airflow can be regarded as fully developed. The convective heat transfer coefficients on the surfaces can be calculated using simple empirical correlations (Zhang and Haghghat 2005). Because the pipes are of small diameter, the inter-surface radiation and the buoyancy effects on the airflow and heat transfer processes are negligible. However, in the large cross-sectional ducts as used in Mediå School and Jaer School, these may play important roles on the heat transfer processes because the airflows in the large ducts are far from fully developed (Heiselberg 2004). A CFD simulation for the Mediå School ETAHE conducted by Zhang and Haghghat (2005) illustrated the complexity of the processes.

4.3.4. Energy cost for fan

An ETAHE is not a completely free energy source. In most systems, a certain amount of energy has to be spent to circulate the air. To enhance the heat convection one may think of having longer pipes, enlarging their surface area and roughness, or creating turbulence etc. However, these also result in more energy cost for circulating the air. In addition, the dissipation of fan's energy may release heat to the circulating air.

4.4. Design criteria

- Airflow rates through an ETAHE need to satisfy the airflow requirement of the buildings assuming the ETAHE is the only air entrance for the building.
- It is desirable to maximize the heat transfer rate between air and duct wall while also minimizing the airflow resistance.
- For buildings with displacement ventilation, the exit temperatures from ETAHEs should always be below that of the room air.
- Condensation and moisture infiltration on the ETAHE duct wall should be avoided.
- The hygrothermal properties of soil need to be considered in the site selection.
- The buried ducts should be anticorrosive and structurally stable.
- An ETAHE provides a path between outdoor and indoor. Safety, insect entrance, and noise transmission should be taken into account.
- Long term operation of an ETAHE with a high heating or cooling load may exhaust its capacity. System recharge methods need to be decided in system control design.

- Ducts should be accessible for inspection and cleaning.

4.5. Application field

ETAHE's application is not restricted to particular building types. A large number of ETAHE systems have been implemented in greenhouses and livestock houses, as well as in residential and commercial buildings. ETAHE's working principle makes it applicable to wide range of climates with large temperature differences between summer and winter and between day and night. In the IEA-ECBCS Annex 28, Zimmermann and Remund (2001) estimated a typical ETAHE system's cooling peak performance and yearly output performance in many European cities. A demonstration project indicated that ETAHEs are suitable for residential houses in southern Europe (Burton 2004). The cooling potential of ETAHE systems in a desert climate was investigated by Al-Ajmi et al. (2006). Their simulations showed that ETAHEs have the potential of reducing cooling energy demand in a typical Kuwaiti house by 30% over the peak summer season. Hollmuller et al. (2005a) analyzed the potential of ETAHEs to be used in mild Brazilian climates (Sao Paulo or Florianopolis) by numerical simulation. It was claimed that ETAHE technology is not a convincing alternative to direct night ventilation.

4.5.1. Applications of ETAHE with emphasis on heating

When an ETAHE is used for heating in winters, additional air conditioning devices are usually necessary. In the heating mode, an ETAHE is usually coupled with a heat recovery unit to help prevent icing. Figure 4.16 shows an example of a temperature progression of the air in such an application (ETAHE and heat recovery system).

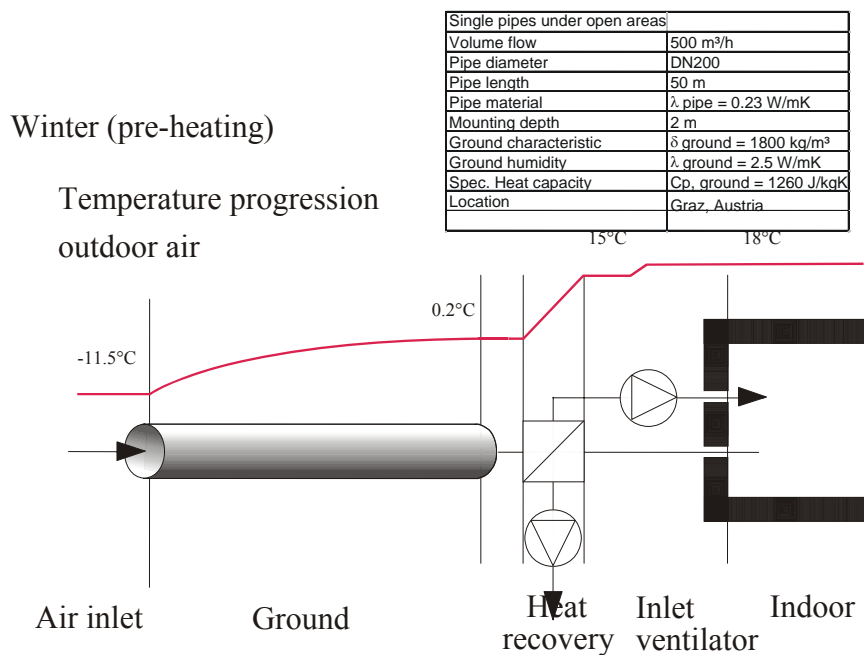

Figure 4.16: Example of a temperature lift of air in an ETAHE with heat recovery during the winter operation. (Fink et al. 2002)

The advantage of this application is that the dimension of the ETAHE can be kept small and thereby the investment costs can also be kept low.

4.5.2. Applications of ETAHE with emphasis on cooling

An ETAHE is basically suitable for independent cooling of indoor air as well as for supplementation for other cooling systems. Figure 4.17 shows an example of the temperature progression of the inlet air when the ETAHE is operated during cooling seasons.

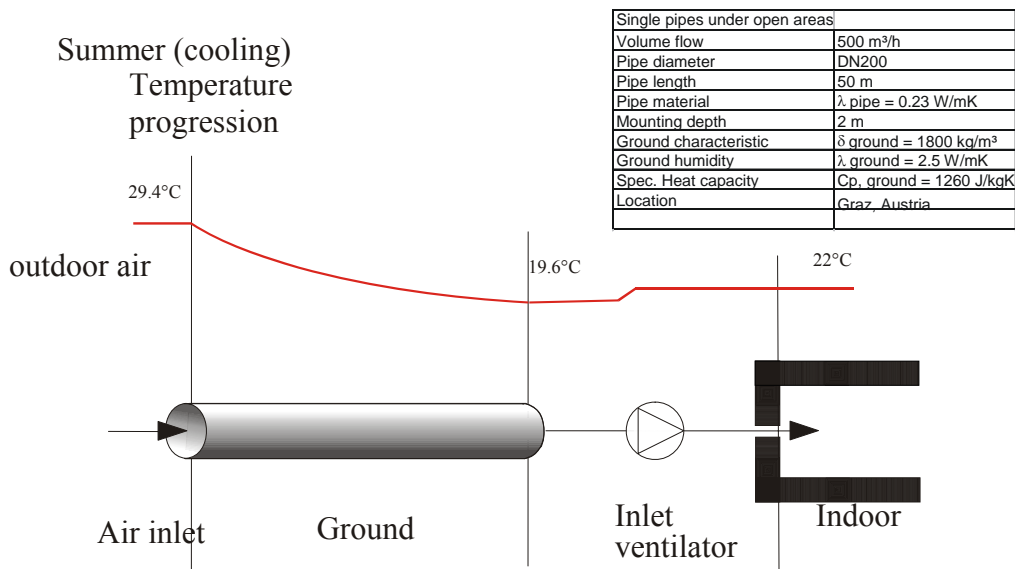

Figure 4.17: Example of a temperature progression of air in an ETAHE during the summer operation. (Fink et al. 2002)

Since the ground soil simply pre-cools the outdoor air, the incoming air can be treated through further measures or the remaining heat load can be removed by static cooling surfaces (e.g. cooled ceilings and slab cooling). Cooling possibilities for the ETAHEs are:

- natural night ventilation
- mechanical night ventilation
- component cooling

4.6. Available design tools

Santamouris and Asimakopoulos (1996) presented a calculation chart, which can predict an outlet air temperature given ETAHE's length, diameter, depth, air velocity and inlet air temperature. The method is based on simplified statistical analysis and regression techniques so its accuracy and features are limited.

WKM (available at <http://www.igjzh.com/huber/wkm/wkm.htm>) is a computer program developed to size ETAHEs with the following features:

- yearly simulation of the ground system with heat recovery and bypass
- weather data can easily be integrated

- collective ducts and funnels are considered
- calculation of pressure drop in the ground
- type of pipe and ground characteristics are suggested
- influence of basement is taken into account
- excel interface for input and output
- the air ventilation way and airflow rates are selectable

The Division of Building Physics and Solar Energy, University of Siegen, Germany, developed commercial software, GAEA (Graphische Auslegung von Erdwärme Austauschern) for design of ETAHE (Benkert et al. 1997, Benkert and Heidt 1998, Benkert 2000). This software is based on calculations of heat exchange among the soil, the buried pipes and the air in the system. The variations of soil temperature, airflow rate, and ambient air temperature are taken into account. An optimization routine presents a choice of possible layout variations and their assessment concerning heat gains and economics. A validation study of GAEA was published by Heidt and Benkert (2000).

Under the framework of the IEA-ECBCS Annex 28, early design guidance for different weather conditions and locations was developed by Zimmermann and Remund (2001) with a few design charts and tables. In an EU project, a design tool was developed under the guidance of AEE Gleisdorf and Fraunhofer ISE by 15 engineering companies (Reise 2001).

De Paepe and Janssens (2003) developed a one-dimensional analytical method, which can be used to analyze the influence of the design parameters of an ETAHE on its thermo-hydraulic performance. A relationship between a specific pressure drop and the thermal effectiveness was derived. This was used to formulate a design method which can be used to determine ETAHE's characteristic dimensions. The desired design is defined as a system with optimal thermal effectiveness as well as an acceptable pressure loss. The choice of the characteristic dimensions thus becomes independent of the soil and climatological conditions. This method is claimed to allow designers to choose a proper configuration for an ETAHE with an optimal performance.

TRNSYS (Klein et al. 2004) is a transient system simulation program with a modular structure that can be designed to solve complex energy system problems by breaking the problem down into a series of smaller components. Hollmuller and Lachal (1998) developed an ETAHE model compatible with the TRNSYS environment. Energy and mass balance within underground ducts account for sensible as well as latent heat exchanges between air and ducts, frictional losses, diffusion into surrounding soil, as well as water infiltration and flow along the ducts. Local heating from integrated fan motor can be taken into account at the duct inlet or outlet. Direction of airflow can be controlled (stratification in case of heat storage) and flexible geometry allows for non-homogenous soils and diverse border conditions.

4.7. Available experimental procedure to assess element performances

ETAHE's performances are directly related to the variations of the airflow's temperature and energy. There is not a standard experimental procedure for evaluating the performances. Usually, the following parameters involved in the energy transfer processes are monitored:

- Sensible and latent heat changes of airflow

- Airflow rate
- Pressure drop through an ETAHE
- Effect of ETAHE on soil temperature distribution

In case of the large cross-sectional ducts, the experimental setup needs to take into account the possible non-uniform distributions of air velocity, air temperature, or surface temperature in order to obtain the average results. It should be noted that conductive heat flow within the earth is a slow process. It may take a few months for the soil temperature to be established after an EATHE starts working. The process is always dynamic since ambient temperatures change hourly and seasonally, as well as the soil temperature profile does. Therefore, long-term monitoring is needed to evaluate the performance. Some examples for the detailed experimental procedures can be found from studies reported by Tzaferis et al. (1992), Hollmuller (2002), Kumar et al. (2003a), Pfafferott (2003), Burton (2004), Wachenfeldt (2003), and Ghosal et al. (2004).

4.8. Availability of measured performances

Several ETAHE systems have been monitored and reported for various purposes, such as evaluation, simulation validation, optimal control determination, and commissioning. Some detailed reports are available in Hollmuller (2002), Kumar et al. (2003a), Pfafferott (2003), Wachenfeldt (2003), Burton (2004), and Ghosal et al. (2004). The previously presented three building examples have all been monitored. Some important results are presented in this section.

4.8.1. Schwerzenbacherhof building, Zurich, Switzerland

Schwerzenbacherhof building was selected as a case study to investigate the performance of ETAHE as a low energy cooling measure in the IEA-ECBCS Annex 28 project. A one year monitoring program was conducted. The monitored parameters from the ETAHE system are

- Upper soil temperature (75 cm above the pipe bed)
- Lower soil temperature (600 cm beneath pipe bed)
- Inlet/outlet air temperatures and humidity.

From this monitoring program, Liddament (2000) reported the following performance conclusions:

- The measured heating demand is 150 kW at -8°C . Without ETAHE, the estimated load would be 240 kW. The ETAHE itself can meet a peak demand of 60 kW.
- The measured heating energy consumption was 144 MJ/m^2 per year which is well below the Swiss Standard, at the time, of 240 MJ/m^2 per year
- The measured electrical current to operate the ventilation system was 23 MJ/m^2 per year which, again, was well below a conventional requirement of 90 MJ/m^2 per year.
- The maximum cooling rate was 54 kW at an outdoor supply temperature of 32°C .
- Comfort cooling was achieved at all times.

4.8.2. Mediå School, Gong, Norway

The cooling effects of the ETAHE in a typical summer week were investigated by Tjelflaat (2000b) by monitoring the inlet and outlet air temperatures, shown in Figure 4.18. The maximum temperature reduction was 8°C. A rough estimation, based on the efficient ETAHE surface area of 200 m² and the airflow rate of 1.1 m³/s, gave an average heat transfer rate of 12 kW.

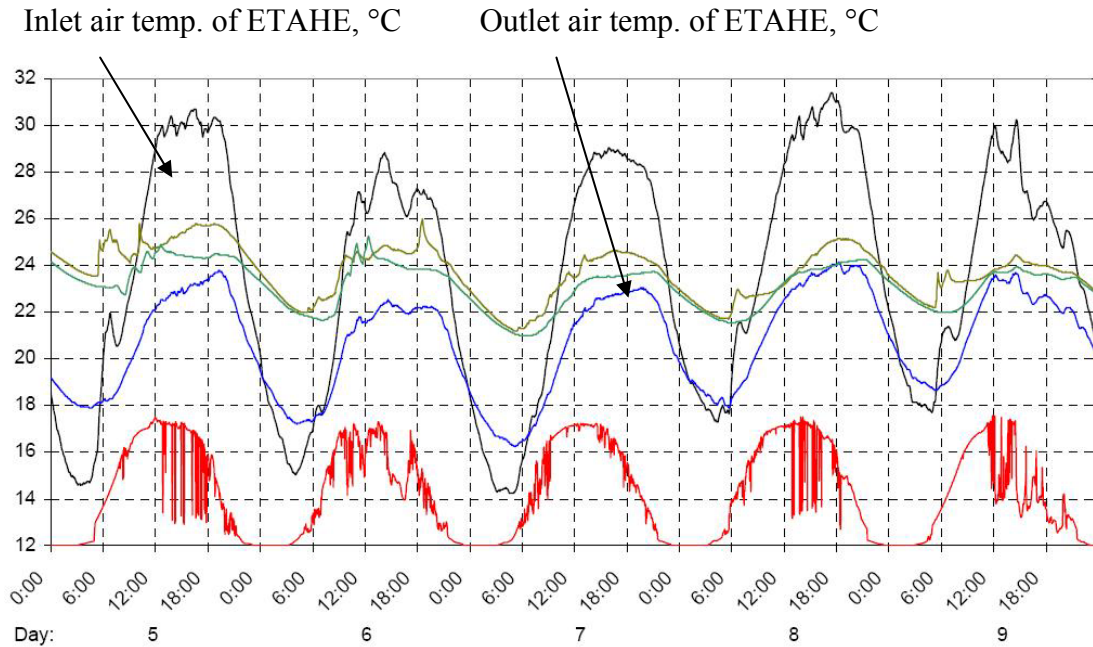

Figure 4.18. Air temperature developments during extremely hot period 5-9 June 2002 (Tjelflaat 2000b)

Based on the measured airflow rates, air temperatures at the inlet and outlet, and the duct surface temperatures, Wachenfeldt (2003) claimed that the average convective heat transfer coefficients of the duct surfaces were significantly larger than those predicted from empirical correlations (valid for fully developed turbulent airflow). To find the reason for the difference, vertical air velocity and air temperature profiles were measured at the middle of the duct as shown in Figure 4.19. The greatly stratified velocity and temperature distributions indicate that the airflow in the large ETAHE duct was far from fully developed.

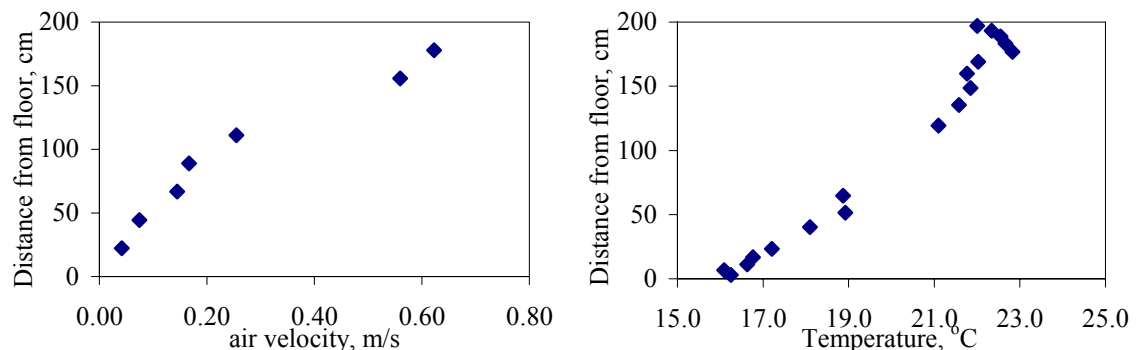

Figure 4.19. Measured vertical air velocity and temperature profiles in the air intake duct when the supply fan was off, the inlet air temperature was 23.7 °C, and the air flow rate was 0.931 m³/s. The location was 6.1 m from the supply fan on the middle plane. The duct end (refer to 5 in Figure 4.7) was partially sealed with the upper 1/3 area open.

4.8.3. Jaer School, Oslo, Norway

The monitored inlet and outlet air temperatures in the Jaer School ETAHE system are reported by Schild (2001). The ambient temperature oscillation was clearly dampened as shown in Figure 4.20.

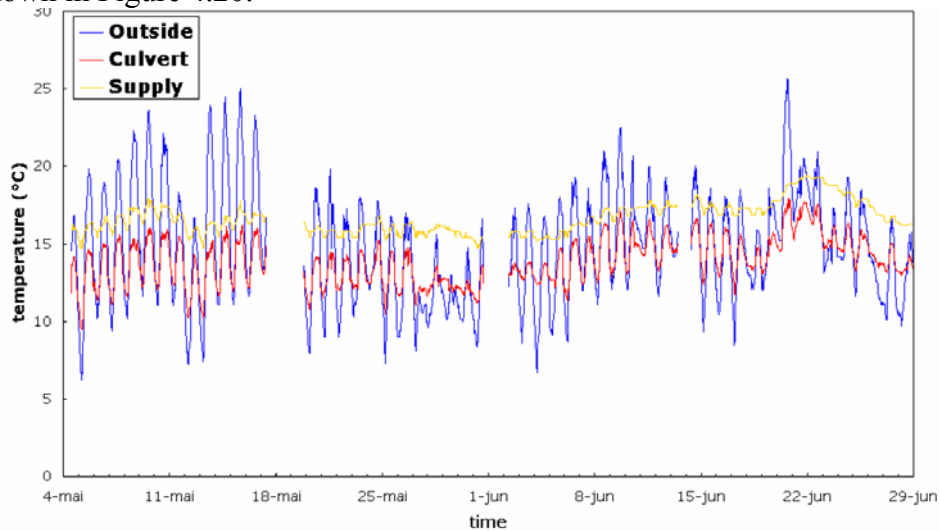

Figure 4.20. Measured air temperatures of the Jaer School ETAHE system. “Culvert” line is the outlet air, “outside” is the ambient air, and “supply” is the air after the preheat unit (Schild 2001).

4.9. Availability of simulated performances

The energy saving potential of ETAHE has attracted many simulation studies since the 1980s. The main efforts have been spent on the development of the simulation methods. Since the performance of large cross-sectional ETAHEs has not been well studied, existing simulation methods were developed based on the working principle of the conventional small pipe systems. As noted earlier, the major difference of the large cross-sectional duct systems from the small ones is the complexity of the heat transfer processes. All the modelling methods reviewed here assume simple convective heat transfer.

By assuming an undisturbed temperature of the earth surface in contact with the ETAHE pipe, Athienitis et al. (2005), De Paepe and Janssens (2003) and Al-Ajmi et al. (2006) used an analytical relationship to calculate variation of air temperature along the pipe length. However, this is only a simple estimation method, and does not account for heat transfer in the soil and other processes in ETAHEs.

Sawheny and Mahajan (1994), Sodha et al. (1994), Sodha et al. (1985) and Krarati and Kreider (1996) proposed a steady-state analytical model to determine the annual heating and cooling potential of an underground air pipe system, while soil temperature was assumed as the mean annual temperature.

Several authors have presented theoretical studies based on numerical techniques to investigate the performance of ETAHE systems, for example, Chen et al. 1984, Schiller 1982, Levit et al. 1989, Elmer and Schiller 1981, Santamouris and Lefas 1986, Sodha et al. 1984, Rondriguez et al. 1988, Shukla et al. 2006, and Seroa da Motta and Young 1985. All these models assumed the soil surrounding an ETAHE to be undisturbed and homogeneous with a constant temperature, the value of which is obtained from an undisturbed soil temperature

algorithm. The models are based on the principle of dividing a pipe into a number of control volumes. A heat balance relationship is applicable to every control volume as shown in Figure 4.21. Using the exit air temperature from the first control volume as the inlet air temperature of the next control volume, the exit temperature for that volume can be calculated in a similar way. Continuing this way from one volume to the next, the temperature of air at the outlet of the ETAHE duct can be calculated.

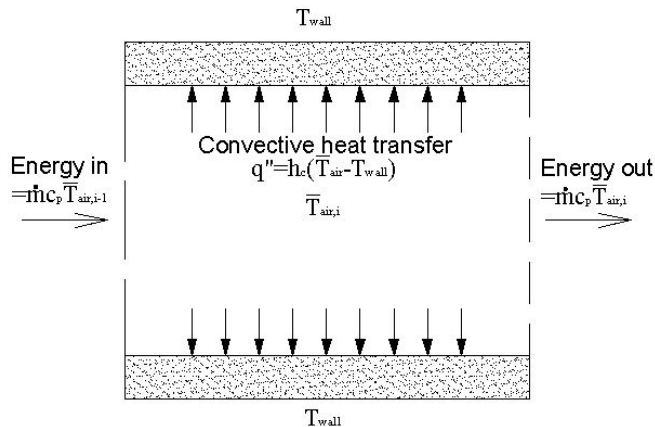

Figure 4.21. Heat convection between ETAHE walls and air

All the aforementioned models have simplified dynamic heat transfer in the soil with steady soil temperatures. Although they are easy to handle, the dynamic processes in the soil are neglected. According to a soil temperature model developed by Bansal et al. (1983), soil properties and surface conditions can greatly influence the ETAHE thermal performance. Mihalakakou et al. (1996) also concluded that earth surface conditions might be a significant controllable factor for the improvement of the ETAHE performance. The thermal analysis of soil surrounding ETAHEs requires the solution of a three-dimensional heat conduction equation with appropriate boundary conditions. Matching the solution on all edges and corners makes the solution of such problems very difficult. Different authors have made different assumptions for solving these equations.

Goswami and Dhaliwal (1985), Goswami and Ileslamlou (1990), and Arzano and Goswami (1996) reported the development of a model, which assumes that heat transfer in the soil only happens in the radial direction and the radius of the effected cylinder of earth is finite. In regions outside of the cylinder, the soil temperatures are undisturbed.

Model developed by Mihalakakou et al. (1994a) considers that the energy transfer inside the soil is driven by simultaneous heat and moisture transfer gradients along both axial and radial directions. By superimposing the heat transfer from more than one duct, Mihalakakou et al. (1994b) modified the previous model to be capable of simulating multiple-pipe ETAHEs. The authors defined the difference of the inlet and outlet air temperatures as the ETAHE's energy potential. Using this definition, the systems' sensitivity to duct length, duct radius, soil depth, and distance between adjacent ducts was analyzed. Jacovides and Mihalakakou (1995) used the same model to simulate an ETAHE buried under a building foundation. Kumar et al. (2003a and 2003b) used it again and defined the ETAHE energy potential as the daily or monthly integration of the convective heat flux between the air and the ETAHE walls. They adopted this energy potential to conduct a parametric study to evaluate the importance of design parameters.

Bojic et al. (1997) developed a method to solve the heat transfer in the soil by horizontally dividing the earth into a number of parallel layers, each having a uniform temperature. Heat transfer among the soil layers is solved using energy balance equations for each soil layer.

Bojic et al. (1999) modified the method by dividing the earth layers into smaller control volumes.

Wagner et al. (2000) and Beisel (1999) developed a model to simulate the performance of ETAHEs by solving similar unsteady conductive heat transfer problem in special coordinates. They used cylindrical control volume close to and Cartesian control volume far away from the ducts. The modeling was conducted with the simulation tool, SMILE.

Mihalakakou et al. (2003) developed a simulation tool using an Artificial Neural Network model. They used the validated numerical model developed by Mihalakakou et al. (1994a) to simulate the thermal performance of ETAHE with a wide range of design parameters. The simulation results were used to train the neural network model. Comparison between simulation results from the neural network model and the numerical model showed good agreements.

4.10. “Claimed” benefits

- ETAHEs can save energy for winter heating and summer cooling when conditioning the indoor environment.
- Appropriately sized ETAHE systems may avoid the use of other mechanical cooling systems.
- ETAHEs can reduce CO₂ emissions.
- ETAHEs can improve indoor thermal comfort.
- Appropriate exploitation of moisture transfer between air and soil may realize moisture control for the supply air.
- ETAHE’ ducts have a filtration effect (concentration reduction of airborne particle, spores and bacteria after passing ETAHE)
- Sometime ETAHEs are cheaper and easier to construct than active cooling systems.
- Maintenance and operation costs are low.
- ETAHEs have a very long lifespan.
- The outlet air from ETAHEs can be further treated by other air handling units. ETAHEs are compatible with other ventilation system components
- General availability of pipe materials makes ETAHE systems easy to be replicated anywhere.

4.11. Limitations

- Land availability limits the use of ETAHEs. Installing ETAHE under the building foundation is one solution.
- ETAHEs are usually not suitable for retrofit of an air conditioning system.

- As far as construction is concerned, rocky ground is not suitable for ETAHE application due to the excavation difficulties.
- Air quality may restrict the location of ETAHE's inlet. ETAHEs are not recommended in areas with radon gas.
- Access for insects and small animals into the ETAHE duct should be avoided.
- Cooling process of ETAHEs may increase the relative humidity of air. Condensation may happen in worse cases. An additional dehumidification device may be needed.
- There might be a risk to poor air quality, namely, the potential of microbial growth in the airway. Fungal growth is potentially the biggest problem and is likely to occur where there is standing water.

4.12. Future perspectives

ETAHE technology has been used in many buildings with good success. It has been proven applicable for wide range of climates and various types of buildings, such as livestock houses, greenhouses, residential and commercial buildings. In terms of cost, the initial investment is very dependent on project specifics. It might be higher than conventional active cooling methods. For buildings with moderate cooling load, properly sized ETAHE systems may become alternatives to many mechanical heating and cooling systems. Significant energy savings and corresponding reduction of CO₂ emission will attract more and more applications. Buildings with the following favorable factors may become the potential users of ETAHEs:

- moderate cooling loads
- low ground temperature
- large daily outdoor air temperature swings
- relatively low requirements for indoor environment
- displacement ventilation system

Hybrid ventilation has very good potential for future building applications. When an ETAHE needs to be integrated into a hybrid ventilated building, the pressure loss through the duct is a critical issue. Large cross-sectional area ducts are favorable for the integration.

4.13. Barriers to application

- ETAHEs provide a path for outdoor noise transmitting to indoor. Plus, many systems are equipped with electrical fans in their ducts. There are concerns that some systems may contravene current noise regulations.
- ETAHEs techniques do not appear completely safe for the environment in terms of contamination of soil, underground water, and microbial growth in the airway.
- There is a general lack of easy-to-use design methods. Existing modeling methods are not accessible for designers. Training programs need to be promoted.

- Design of ETAHE's control strategies vary significantly between countries and regions because of climate differences. Such variations impact technology transfer and adoption of best practice.
- Many building owners and equipment installers lack confidence in new energy technologies. Frequent conservative reflexes when it comes to investment will often lead to more conventional choices.
- The system costs are very dependent on the actual project. In some cases, the initial investment for installing an ETAHE might be more expensive than regular air conditioning system. This may cause less attraction for building owners. However, it should be noted that an ETAHE has very long lifespan. The energy saving potential should be considered as a competitive alternative.
- The installation of the heat exchangers should be carried out with high precision in regards to the hygienic regulations, declined mounting and leak tightness. Construction supervision from designers or HVAC experts is therefore often necessary at the site. These extraordinary installation demands could be a reason why the heat exchangers have presently not established a growing market demand.

4.14. Open questions and future research work to be done

Although many simulation studies have been done in this area and many applications have achieved successful performances, there are still some issues that need to be studied in the future.

- simulation of complex airflow and heat transfer in large cross-sectional ETAHE ducts
- control strategy optimization
- the balance between heating and cooling (diurnal and seasonal)
- long-term monitoring for soil temperature development (whether the capacity of the system is sustainable)
- interrelated constraints between minimizing initial investment, enhancing heat transfer, and reducing operation cost
- integrated system design under the whole building concept (taking into account the interaction between ETAHE and building energy system) to achieve system optimization
- development of design tools
- cost estimation

4.15. References

- Al-Ajmi, F., Loveday, D.L., and Hanby, V.I. (2006). *The Cooling Potential of Earth-Air Heat Exchangers for Domestic Buildings in a Desert Climate. Building and Environment*, 41(3), 235-244.
- Arzano, L. and D. Y. Goswami (1996). *Performance Analysis of a Closed Loop Underground Air Tunnel for Residential Housing in a Hot and Humid Climate*.
- ASHRAE. (2000). *ASHRAE Handbook - HVAC Systems and Equipments, Chapter 11*. Atlanta, Georgia.
- Athienitis, A.K., Roy, M., and Zhao, M. (2005). *Design and Simulation of a Hybrid Ventilation System with Earth-Air Heat Exchanger. Ninth International IBPSA Conference, Building Simulation 2005, Montreal, Canada, 1, 27-32, Aug. 15-18, 2005*.
- Bansal, N.K., Sodha, M.S., and Bharadwaj, S.S. (1983). *Performance of Earth Air Tunnels. International Journal of Energy Research*, 7(4), 333-345.
- Beisel, S. (1999), *Vermessung, Modellierung und Bewertung des Erdreichwärmeübertragers beim Passiv-Solarhaus Cölbe, Diplomarbeit, Universität Marburg*.
- Benkert, S. (2000). *Abschlussbericht Zum Projekt Validierung Des Programms 'Graphische Auslegung Von Erdwärmeaustauschern Gaea' Mit Hilfe Von Messdaten Im Rahmen Des Verbundprojekts 'Luft-/Erdwärmetauscher' Der Ag Solar NRW*.
- Benkert, S., and Heidt, F.D. (1998). *Designing Earth Heat Exchangers with GAEA. Proceedings EuroSun '98, Volume IV. IV.2.2, pp. 1-7*.
- Benkert, S., Heidt, F.D., and Scholer, D. (1997). *Calculation Tool for Earth Heat Exchangers GAEA. Proceeding of Building Simulation, Fifth International IBPSA Conference, Prague, Vol. 2, pp. 9-16*.
- Bojic, M., N. Trifunovic, and C. Papadakis and S. Kyritsis (1997), *Numerical Simulation, Technical and Economic Evaluation of Air-to-Earth Heat Exchanger Coupled to a Building, Energy* 22(12) pp.1151-1158.
- Bojic, M., G. Papadakis, S. Kyritsis (1999). *Energy from a two-pipe, earth-to-air heat exchanger, Energy (Oxford)* 24(6) pp. 519-523.
- Boulard, T., Razafinjohany, E., and Baille, A. (1989). *Heat and Water Vapour Transfer in a Greenhouse with an Underground Heat Storage System Part I, Experimental Results. Agricultural and Forest Meteorology, Vol. 45(3-4), pp. 175-184*.
- Burton, S. (2004). *COOLHOUSE Final Technical Report. Energie Demonstration Project NNE5 –1999 -193 FaberMaunsell Ltd, London*.
- Carmody, J.C., Meixel, G.D., Labs, K.B., and Shen, L.S. (1985). *Earth-Contact Buildings*

- Applications, Thermal Analysis and Energy Benefits. Advances in Solar Energy, Vol. 2, Chapter 6, pp. 297-347.*
- Chen, B., Wang, T., Maloney, J., and Newman, M. (1984). *Measured and Predicted Cooling Performance of Earth Contact Cooling Tubes. Solar World Congress, Proceedings of the 8th Biennial Congress of the International Solar Energy Society. Vol. 1., Perth, Australia, 332-336.*
- De Paepe, M. and A. Janssens (2003), *Thermo-hydraulic design of earth-air heat exchangers, Energy and Buildings 35(4): 389-397.*
- Elmer, D., and Schiller, G. (1981). *A Preliminary Examination of the Dehumidification Potential of Earth-to Air Heat Exchangers. Proc. ASES 1983 Annual Meeting, Minneapolis, MN.*
- Fink, C., Blümel, E., Kouba, R., and Heimrath, R. (2002). *Passive Kühlkonzepte Für Büro- Und Verwaltungsgebäude Mittels Luft- Bzw. Wasserdurchströmten Erdreichwärmetauschern.*
- Fjaerem, A. (2004). *Coolhouse - Final Monitoring Report. Energie Demonstration Project NNE5 –1999 -193 FaberMaunsell Ltd, London.*
- Ghosal, M.K., Tiwari, G.N., Srivastava, N.S.L., and Sodha, M.S. (2004). *Thermal Modelling and Experimental Validation of Ground Temperature Distribution in Greenhouse. International Journal of Energy Research, 28(1), 45-63.*
- Goswami, D.Y. and Dhaliwal A.S.(1985), *Heat Transfer Analysis in Environmental Control Using an Underground Air Tunnel, Journal of Solar Energy Engineering, Vol. 107, pp.141-145.*
- Goswami, D.Y., and Ileslamlou, S. (1990). *Performance Analysis of a Closed-Loop Climate Control System Using Underground Air Tunnel. Journal of Solar Energy Engineering, Transactions of the ASME, 112(May), pp. 76-81.*
- Heidt, F.D., and Benkert, S. (2000). *Designing Earth Exchangers-Validation of the Software GAEA. Proceedings World Renewable Energy Congress VI, Brighton, UK, pp. 1818-1821.*
- Heiselberg, P. (ed.) (2002). *Principle of Hybrid Ventilation. Aarhus University Center, Denmark.*
- Heiselberg, P. (2004). *Building Integrated Ventilation Systems - Modelling and Design Challenges. CIB 2004 World Building Congress, Toronto, Canada.*
- Hollmuller, P. (2003). *Analytical Characterisation of Amplitude-Dampening and Phase-Shifting in Air/Soil Heat-Exchangers. International Journal of Heat and Mass Transfer, 46(22), 4303-4317.*
- Hollmuller, P. (2002). *Utilisation Des Échangeurs Air/Sol Pour Le Chauffage Et Le Rafraîchissement Des Bâtiments Mesures in Situ, Modélisation Analytique, Simulation*

- Numérique Et Analyse Systémique, Ph.D. Thesis, Université de Genève, Genève.*
- Hollmuller, P., and Lachal, B. (1998). *TRNSYS Compatible Moist Air Hypocaust Model - Final Report. Centre universitaire d'étude des problèmes de l'énergie, Université de Geneve.*
- Hollmuller, P., and Lachal, B. (2005). *Buried Pipe Systems with Sensible and Latent Heat Exchange: Validation of Numerical Simulation against Analytical Solution and Long-Term Monitoring. 1. Ninth International IBPSA Conference, Building Simulation 2005, Montreal, Canada, 411-418.*
- Hollmuller, P., Lamberts, R., Westphal, F., Ordenes, M., and Carlo, J. (2005a). *Potential of Inertial Ventilation for Passive Cooling in Brazilian Climates. Proceedings of Passive and low energy cooling for the built environment (PALENC 2005), Santorini, Grece.*
- Hollmuller, P., Lachal, B., and Pahud, D. (2005b). *Rafraîchissement Par Geocooling: Bases Pour Un Manuel De Dimensionnement. Rapports de recherche du CUEPE n° 5 2005.*
- Jacovides, C.P., and Mihalakakou, G. (1995). *Underground Pipe System as an Energy Source for Cooling/Heating Purposes. Renewable Energy, 6(8), 893-900.*
- Klein, S.A., Beickman, J.W., Mitchell, J.A., Duffie, N.A., Freeman, J.C., Mitchell, J.E., Braun, B.L., Evans, J.P., Kummer, R.E., Urban, A., Fiksel, J.W., Thornton, N.J., Blair, P.M., Williams, D.E., Brandley, T.P., and McDowell, M.K. (2004). *TRNSYS 16 - a Transient System Simulation Program, User Manual. Solar Energy Laboratory, Madison: University of Wisconsin-Madison.*
- Kumar, R., Ramesh, S., and Kaushik, S.C. (2003a), *Performance evaluation and energy conservation potential of earth-air-tunnel system coupled with non-air-conditioned building, Building and Environment 38(6): 807-813.*
- Kumar, R., Srikonda, A.R. and Kaushik, S.C. (2003b), *Cooling and heating potential of earth-air tunnel heat exchanger (EATHE) for non-air-conditioned building, International Journal of Global Energy Issues 19(4): 373-386.*
- Kusuda, T., and Bean, W. (1983). *Annual Variation of Temperature Field and Heat Transfer under Heated Ground Surface, Slab-on Grade Floor Heat Loss Calculation. Building Science Services 156, Gaithersburg, MD: National Bureau of Standards.*
- Labs, K. (1989). *Passive Cooling, The MIT press, Cambridge Massachusetts, London, England.*
- Levit, H.J., Gaspar, R., and Piacentini, R.D. (1989). *Simulation of Greenhouse Microclimate Produced by Earth Tube Heat Exchangers. Agricultural and Forest Meteorology, 47(1), 31-47.*
- Liddament, M.W. (ed.) (2000). *Low Energy Cooling, IEA-ECBCS Annex 28 Technical Synthesis Report.*
- Mihalakakou, G., Santamouris, M., and Asimakopoulos, D. (1994a). *Modelling the Thermal*

- Performance of Earth-to-Air Heat Exchangers. Solar Energy, 53(3), 301-305.*
- Mihalakakou, G., Santamouris, M., and Asimakopoulos, D. (1994b). Use of the Ground for Heat Dissipation. Energy (Oxford), 19(1), 17-25.*
- Mihalakakou, G., Lewis, J.O., and Santamouris, M. (1996). The Influence of Different Ground Covers on the Heating Potential of Earth-to-Air Heat Exchangers. Renewable Energy, 7(1), 33-46.*
- Mihalakakou, G. (2003), On the Heating Potential of a Single Buried Pipe Using Deterministic and Intelligent Techniques, Renewable Energy 28(6): 917-927.*
- Pfafferott, J. (2003). Evaluation of Earth-to-Air Heat Exchangers with a Standardised Method to Calculate Energy Efficiency, Energy and Buildings 35(10): 971-983.*
- Reise, C. (2001). Planning Tool for Earth-to-Air Heat Exchangers.*
- Rondriguez, E.A., Cjudo, J.M., and Alvarez, S. (1988). Earth Tube Systems Performance. Proc. CIB Meeting, Air Quality and Air Conditioning, Paris, France.*
- Santamouris, M., and Asimakopoulos, D.N. (1996). Passive Cooling of Buildings, James & James, London.*
- Santamouris, M., and Lefas, C.C. (1986). Thermal Analysis and Computer Control of Hybrid Greenhouse with Subsurface Heat Storage. Energy in Agriculture, 5, 161-173.*
- Schild, P.G. (2001). An Overview of Norwegian Buildings with Hybrid Ventilation. HybVent Forum '01 Delft University of Technology, The Netherlands.*
- Schild, P.G. (2002a). Jaer School. IEA ECBCS Annex-35 (HybVent) Technical Report, Nesodden Municipality, Norway.*
- Schild, P.G. (2002b). Hybrid Ventilation of Jaer School: Results of Monitoring. Hybrid Ventilation 2002 : 4th International Forum, Montreal, Canada.*
- Schiller, G. (1982). Earth Tubes for Passive Cooling, the Development of a Transient Numerical Model for Predicting the Performance of Earth-to-Air Heat Exchangers, M.Sc. thesis, MIT, MIT.*
- Seroa da Motta, A.L.T., and Young, A.N. (1985). Predicted Performance of Buried Pipe Cooling Systems for Hot Humid Climates. Solar Engineering - 1985, Proceedings of the Joint ASME-ASES Solar Energy Conference (SED Seventh Annual Conference). Knoxville, TN, Belg, 74-81.*
- Shukla, A., Tiwari, G.N., and Sodha, M.S. (2006). Parametric and Experimental Study on Thermal Performance of an Earth-Air Heat Exchanger. International Journal of Energy Research, 30(6), 365-379.*
- Sinha, R.R., Goswami, D.Y., and Klett, D.E. (1982). Theoretical and Experimental Analysis of Cooling Technique Using Underground Air Pipe. Solar World Forum, Proceedings of*

- the International Solar Energy Society Congress. Vol. 3, Brighton, Engl, 2105-2114.*
- Sodha, M.S., Goyal, I.C., Bansal, P.K., and Kumar, A. (1984). Temperature Distribution in an Earth-Air Tunnel System.*
- Sodha, M.S., Sharma, A.K., Singh, S.P., Bansal, N.K., and Kumar, A. (1985). Evaluation of an Earth-Air Tunnel System for Cooling/Heating of a Hospital Complex. Building and Environment, 20(2), 115-122.*
- Sodha, M.S., Mahajan, U., and Sawhney, R.L. (1994). Thermal Performance of a Parallel Earth Air-Pipes System. International Journal of Energy Research, 18(4), 437-447.*
- Tjelflaat, P.O. (2000a). Pilot Study Report - Mediå School. IEA ECBCS Annex-35 (HybVent) Technical Report.*
- Tjelflaat, P.O. (2000b). The Grong School in Norway the Hybrid Ventilation System. IEA ECBCS Annex-35 (HybVent) Technical Report.*
- Tzaferis, A., Liparakis, D., Santamouris, M., and Argiriou, A. (1992). Analysis of the Accuracy and Sensitivity of Eight Models to Predict the Performance of Earth-to-Air Heat Exchangers. Energy and Buildings, 18(1), 35-43.*
- Wachenfeldt, B.J. (2003). Natural Ventilation in Buildings Detailed Prediction of Energy Performance, PhD Thesis, Norwegian University of Science and Technology.*
- Wagner, R., Beisel, S, Spieler, A., Gerber, A., and Vajen, K. (2000) Measurement, Modeling and Simulation of an Earth-to-Air Heat Exchanger in Marburg (Germany), 4. ISES Europe Solar Congress, Kopenhagen, Dänemark.*
- Zhang, J., and Haghghat, F. (2005). Simulation of Earth-to-Air Heat Exchangers in Hybrid Ventilation Systems. Ninth International IBPSA Conference, Building Simulation 2005, Montreal, Canada, Vol. 3., pp. 1417-1424.*
- Zimmermann, M. (1995). Ground Cooling with Air, IEA-ECBCS Annex 28 Low Energy Cooling, Subtask 1 Report, Review of Low Energy Cooling Technologies.*
- Zimmermann, M., and Remund, S. (2001). IEA-ECBCS Annex 28 Subtask 2 Report 2, Chapter F Ground Coupled Air Systems. Low Energy Cooling - Technology Selection and Early Design Guidance, N. Barnard and D. Jaunzens, eds., Construction Research Communications Ltd, pp 95-109.*

Chapter 5 Dynamic Insulation Systems (DIW)

5.1. Component description and example of existing application

The concept of dynamic insulation (DI) is to effectively use the combination of conventional insulation and heat exchange characteristics of a wall to pre-heat fresh air for ventilation. It is regarded as one possible method for reducing building envelope heat losses while achieving better indoor air quality. The existing technology of dynamic insulation can be divided into two catalogues:

1. The design using cavities to circulate the fluid (mostly air) in the wall. The air flow direction in the cavities is generally parallel to the wall – wall acting as a heat exchanger.
2. Breathing wall design which let the gas (mostly air) transfer through the permeable insulation. The interaction of gas phase and solid phase can also act as a contra-flux mode heat exchanger (Baker, 2003).

Though ventilated walls which use a combination of air cavities have been presented, such as Baily (1987) and Chebil (2003), currently the research and application of dynamic insulation system focus on the latter, which is also called a breathing wall.

This *Dynamic Insulation (Breathing) Wall* (DIW) concept is illustrated in Figure 5.1. The dynamically insulated walls and roof function as ventilation source, heat exchanger and filter of airborne pollution, specifically *Particulate Matter* (PM). Ventilation air enters the building pre-heated in winter and pre-cooled in summer, using the heating and cooling energy that would otherwise be lost through conduction and convection to atmosphere. At all times, air comes in filtered. DIW thus address the generic, headline requirement of all buildings and building types for efficient heating, cooling, ventilation and good *Indoor Air Quality* (IAQ).

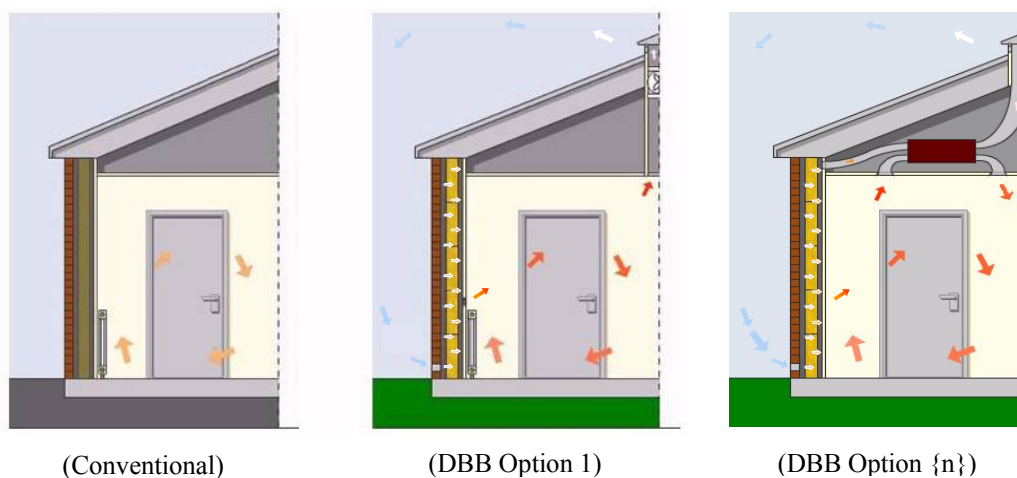

Figure 5.1. DBB concept and implementation using in-wall DI

DIWs potentially use less energy *and at the same time* provide high ventilation rates compared to modern, hermetically sealed buildings that seek isolate the building from its environment. DIW offers high performance thermal insulating properties using thin-wall construction.

The dynamic insulated wall component usually consists of the following main sub-layers:

1. The external envelope sub-layer. This could be a prefabricated reinforced concrete slab (Dimoudi et al, 2004), or a prefortreaded metal sheet (Baker, 2003). The ventilation air can be introduced from the bottom or top of the external envelope sub-layer.
2. The dynamic insulation sub-layer, which may consist of layers of breathing materials, including materials such as compressed straw board, mineral wool and thin paperboard, or cellulose fiber insulation. These breathing materials let the air enter the room due to a pressure difference between interior and exterior.
3. An air gap is generally used to separate these two sub-layers.

In most of the dynamic insulation design, an air permeable internal surface construction is adopted. However, Baker (2003) pointed out that problems might exist with the use of a permeable wall liner. To solve this drawback, plasterboard, which is impermeable to air, is chosen for the inner face of the construction. Air is drawn through the dynamic insulation sub-layer into a cavity behind the plasterboard. From there it is distributed into the room through vents.

Besides configuration of these sub-layers, other considerations in the real dynamic insulation system design include:

1. To assure the uniform air-flow and hence one-dimensional heat transfer through the wall, for the design that air comes into the wall from the bottom of the external layer, the lower 1.0m of the wall is constructed of having a higher air resistance (Dimoudi et al, 2004).
2. Pressure difference between indoor and outdoor for inward air flow can be normally achieved by means of a fan.
3. Solar energy has also been considered to increase the performance of dynamic insulation component. For example, a layer of outer glazing could raise the temperature of incoming air, (Gan, 2000).
4. A heat pump or heat pipe unit has also been suggested to be inserted in the exhaust air duct to pre-heat the incoming air (Gan, 2000).

However, as the energy consumption of the electric system must be offset against the energy saving by dynamic insulation, the technology may not be cost effective, if only the mechanical ventilation system is applied. Therefore, an investigation has been performed to study the technical feasibility of using dynamic insulation with natural ventilation alone (Etheridge and Zhang, 1998). The results indicate that a strong synergy exist between dynamic insulation and wind energy. Therefore there is good potential to extent the application of dynamic insulation to a “natural” system. In the experimental work of dynamic and ventilated wall component (Dimoudi et al, 2004), only wind energy is employed. And one of the objectives of the research by Baker (2003) is to develop practical control strategies to optimize the performance of dynamic insulation, while minimizing electricity consumption required for mechanical ventilation, such as using PV driven fans or passive stack ventilation.

Early work on DIW includes Bartusek on porous roofs (H. Bartusek, 1981), Dalehaug on DIW walls (A. Dalehaug, 1993) and Wallenten on the OPTIMAT house (P. Wallenten, 1993). Fundamental research on the use of diffusive and dynamic insulation for combined heat recovery and ventilation in buildings (B. J. Taylor, D. A. Cawthorne and M. S. Imbabi, 1996; B. J. Taylor and M. S. Imbabi, 1997, 2000) has posed the basis for understanding heat and mass transfer phenomena in dynamic breathing wall systems. Taylor *et al* (B. J. Taylor, R. Webster and M. S. Imbabi, 1998), Imbabi and Peacock (M. S. Imbabi and A. D. Peacock, 2004) and Imbabi (M. S. Imbabi, 2006) have further extended the research in order to include the particulate filtration performance and service life of fibre-based DIW. New research into DIW is being performed by Wong *et al* (J. M. Wong, F. Glasser and M. S. Imbabi, 2005), who have developed a new breathable concrete material for use in monolithic dynamic breathing wall construction.

The market already offers high performance modular dynamic insulation products, such for example the Energyflo™ cell (Figure 5.2). This technology has been developed by The Environmental Building Partnership Limited, United Kingdom. Available in thickness of 90mm, 135mm, 170mm, the product can be used in most building types to reduce energy demand for heating and cooling, and to improve indoor air quality through increased fresh air ventilation. Similar to the dynamic insulated wall presented by Baker (2003) and Dimoudi *et al* (2004), Energyflo™ cell also comprises two components: fiber-base filtration media and a rigid encasement package.

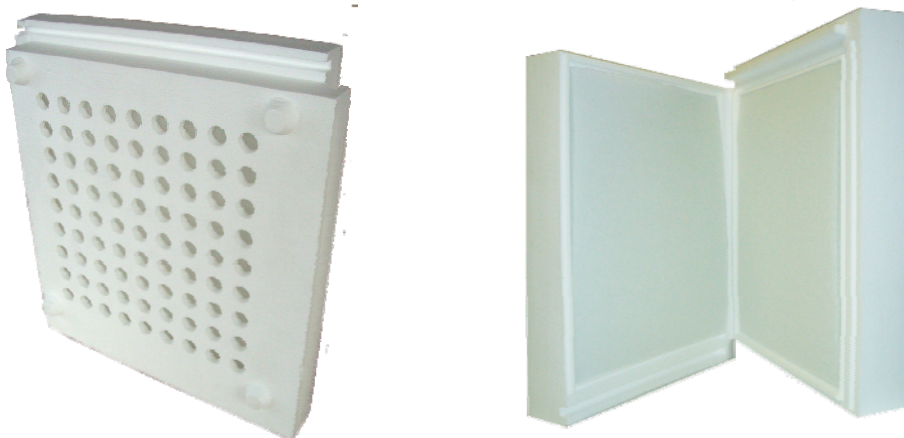

Figure 5.2. An example of Energyflo™ cells (Courtesy of EBP)

5.2. Working principle

Primarily, the function of insulation is to keep the heat contained in the building in the winter season, and to keep the heat out of the building in the summer. Building insulation slows the heat flow by conduction, radiation and convection. In conventional building envelope design, convection occurs as air circulates through the insulation material, and is usually a minor component. However, in dynamic insulation, where air is intensively drawn through the building envelope to reduce the conduction heat loss, the influence of convection has a significant effect on the overall thermal performance of the building envelope. Therefore, both conduction and convection needs to be included in the thermal analysis of dynamic insulation.

It has to be underlined that DIW is still a relatively new technology and that the research has still to be further developed. Results and approaches so far proposed by different research groups, in fact, does not show a complete agreement on and are not generally shared.

In the current application of dynamic insulation, efforts have been made to assure a one dimensional heat transfer. Heat transfer in this situation can be described using the following 1D steady state model (Taylor et al, 1996):

$$k \frac{d^2T(x)}{dx^2} - u\rho_a C_p \frac{dT(x)}{dx} = 0 \quad (1)$$

k - The Thermal conductivity of the wall material (W/m K)

T - The temperature (K)

ρ_a - The density of air (kg/m³)

u - The air velocity (m/s)

C_p - The heat capacity of air (J/kg K)

An analytical solution can be derived on the condition that the temperature on the outer and inner surface of dynamic insulation, as well as the air velocity, is constant. The temperature distribution obtained can be expressed as

$$\frac{T - T_o}{T_i - T_o} = \frac{\exp\left(\frac{u\rho_a C_p x}{k}\right) - 1}{\exp\left(\frac{u\rho_a C_p L}{k}\right) - 1} \quad (2)$$

T_i - The temperature at indoor side (K)

T_o - The temperature at outdoor side (K)

L - The length of the layer (m)

Assuming one dimensional steady state model, the dynamic U -value can be derived as follows*

$$U_{dyn} = \frac{u\rho_a C_p}{e^{\frac{u\rho_a C_p L}{k}} - 1} \quad (3)$$

It is clear that this dynamic U -value is a function of the air velocity, or, more exactly, the Pe number

$$Pe = \frac{u\rho_a C_p L}{k} \quad (4)$$

The dynamic U -value is regarded as a characteristic of the performance of dynamic insulation (Baker, 2003). Table 1 illustrates the dynamic U -value under different air velocities for 200mm cellulose insulation and 200mm porous masonry block such as Pumalite. The table demonstrates that it is preferable to have dynamic insulation using materials which are inherently good insulators. However, masonry material with a higher thermal capacity can be used to produce a composite permeable wall with a low dynamic U -value and high thermal capacity.

Table 5.1 Dynamic U -value versus air flow rate and thermal conductivity (Taylor and Imbabi, 1998)

	Cellulose ($k=0.035\text{W/mK}$)		Pumalite ($k=0.3\text{W/mK}$)	
	Air velocity (m/hr)	U_{dyn} (W/m ² K)	Air velocity (m/hr)	U_{dyn} (W/m ² K)
Air velocity (m/hr)	1	10	1	10
U_{dyn} (W/m ² K)	0.058	1.7E-8	1.34	0.4

Variation of dynamic U -value with thickness of insulation is illustrated in Table 5.2. It shows that the infiltration path needs to be long enough to let the air exchange heat with insulation materials in the wall.

Table 2 Dynamic U -value versus insulation thickness (Taylor and Imbabi, 1998)

	Cellulose (L=200mm)		Cellulose (L=40mm)	
	Air velocity (m/hr)	U_{dyn} (W/m ² K)	Air velocity (m/hr)	U_{dyn} (W/m ² K)
Air velocity (m/hr)	1	10	1	10
U_{dyn} (W/m ² K)	0.058	1.7E-8	0.72*	0.075* ¹

As an example of the analytical model in actual application, the dynamic U -values of walls incorporating Energyflo™ cells are shown in Fig 5.3, with the variation of inward airflow rate through the cells.

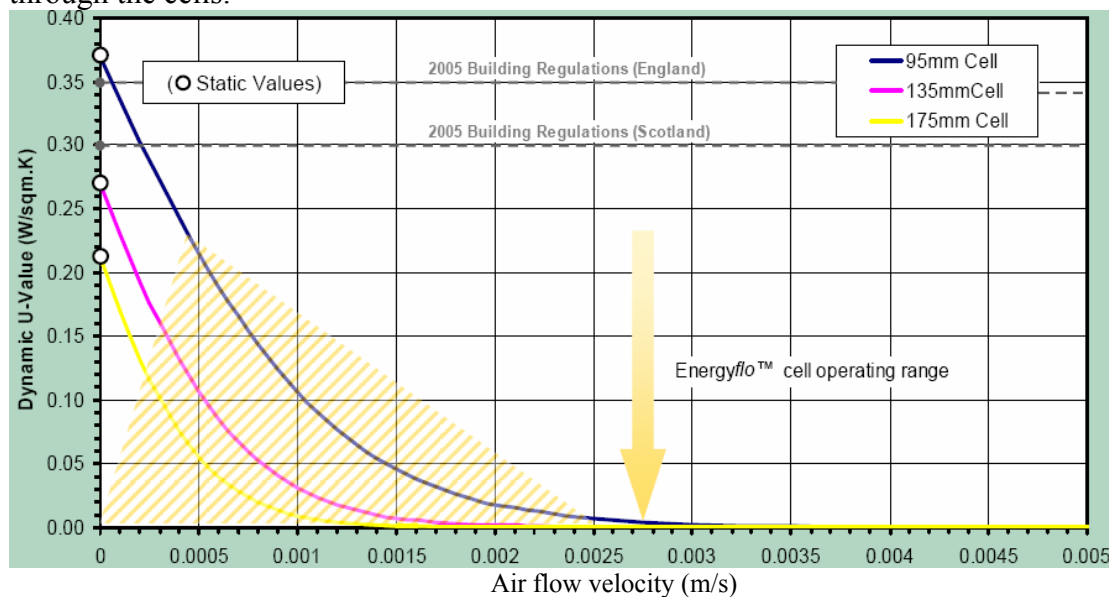

Fig 5.3 Variation of dynamic U value of walls incorporating Energyflo™ cells

Thus, the key principle of dynamic insulation is to determine the insulation thickness and assure the range of airflow rate. This comes from two aspects:

1. To supply adequate fresh air, promote the heat exchange between air and insulation, and to decrease the risk of condensation; the air flow rate should not be too slow;
2. If the incoming air is not pre-heated before it enters the dynamic insulation, and its temperature is equal to the outdoor temperature, the convective heat loss will increase with airflow rate; hence the overall heat loss will increase with airflow rate.

Affected by a combination of the above factors, the air flow rate needs to be in a suitable range. This is not reflected by the results in Fig 1, as the dynamic U -value decreases with the increase of air flow velocity in this case. This is because these results are obtained using equation (3), and only the conductive heat loss is included in this expression.

Besides the advantage of energy saving, the fibrous structure in dynamic insulation may also offer an effective, low energy solution to the air pollution problem in the surrounding environment. This is because the dynamic insulation can act as an air filter.

The polluted particles can be trapped by a filter through three mechanisms (Taylor et al, 1999):

1. Impaction, in which the momentum of the particle causes it to deviate its stream line around the fiber and is captured by the fiber media;
2. Interception, in which the particle follows its streamline and is captured when it comes into contact with the fiber;
3. Diffusion, in which the Brownian motion causes the particle to move independently of the air stream onto the filter media.

For the conventional air filter, the air velocity is up to 1.0 to 1.5m/s, so the particle is only filtered by impaction and interception. As the air velocity in the dynamic insulation is relatively slow, generally 0.0005m/s to 0.005m/s, all three mechanisms are prompted, so the dynamic insulation is very effective for capturing particles less than $0.5\mu\text{m}$ or larger than $5\mu\text{m}$ in diameter. It is pointed out that dynamic insulation is also efficient at capturing particles ranging from $0.5\mu\text{m}$ to $5\mu\text{m}$, if its thickness is greater than 60mm (Taylor and Imbibi, 1999). At this thickness of filter media, the dynamic insulation has the potential to become a high efficiency particle air filter due to the nearly zero particle penetration for all particle sizes.

PM₁₀ filtration performance using fibre-based DIW media has been investigated by Imbabi and Peacock (M. S. Imbabi and A. D. Peacock, 2003), who evaluated filtration efficiency and clogging.

In a loaded fibre filter the internal structure changes over time as branch-like dendrites form through the agglomeration of particles within the filter media. Some of these dendritic fibres themselves start to act as filter fibres, increasing the packing density. Since the collection efficiency increases with dendrite formation, there is no risk of efficiency loss over time. Correctly designed and implemented, theoretical predictions and laboratory tests suggest that the clogging rate of DI media can be slowed down to the point where it ceases to be of concern, even in the most heavily polluted urban and industrial environments, without compromising the filtration efficiency or operation of the building.

Besides the insulation thickness, another factor for the performance of the air filter is the insulation surface area. Experimental investigations on walls with Energyflo™ cells show that if only 10% of the wall is fitted with Energyflo™ cells, it will effectively limit the life of the cell in operation. Whereas for the wall with 50% of area fitted with Energyflo™ cells, and the

wall completely fitted with Energyflo™ cells, there is little difference concerning their performance of being an air filter.

5.3. Application field

The concept of dynamic insulation is well known in Scandinavian countries and was first implemented in Norway in agricultural buildings. However, it can have a wide application field due to the mechanism of its working principle.

First, the temperature difference between indoor and outdoor does not influence the performance dynamic insulation itself, because:

1. Temperature is not included in U -value expressed of equation (3).
2. Numerical simulation on the heat exchange performance of dynamic insulation also demonstrates that the influence of temperature gradient is insignificant (Buchanan and Sherman, 2000).

This suggests that dynamic insulation has the potential to be implemented in most climate conditions. As a matter of fact, besides Scandinavian countries, experimental set-ups for dynamic insulation have been developed in mild climate countries such as United Kingdom (Baker, 2003), Greece (Dimoudi et al, 2004), and Japan (Dalehaug 1993).

However, as dynamic insulation needs de-pressurization of the building, the actual implementation may be different. For the mild and variable climate countries such as UK, the only way to be reliably de-pressurized is by using fans, while in Scandinavian countries where the indoor and outdoor temperature difference in winter reaches 40K, could provide the needed de-pressurization by stack effect.

The ideal type of building for implementation of dynamic insulation is the place that more fresh air is preferred, for example, swimming pools and hospitals. Concerning the energy consumption, it can be used in both business and residential buildings (Baily, 1987), though it may be more appropriate for small detached buildings (Taylor and Imbabi, 1998). It is easy for dynamic insulation elements to fit with other building components.

5.4. Available design tools

Though the concept of dynamic insulation was developed decades ago, the implementation of this technology is still in the early stage. Until now, no special design tools for the design of dynamic insulated wall have been reported. However, concerning the thermal performance, some commonly used building energy analysis tools, such as TRNSYS, can be modified to incorporate dynamic insulation elements.

Due to the very low velocity through the dynamic insulation, heat transfer in it can be regarded to be in local thermal equilibrium, i.e., the local average temperature of air equals

that of the solid matrix, and the effect of thermal dispersion can be ignored. Thus the thermal conductivity in equation (1) can be obtained as

$$k = \varepsilon k_f + (1 - \varepsilon)k_s \quad (5)$$

k_f - The conductivity of air (W/m K)

k_s - The conductivity of solid phase (W/m K)

ε - Porosity of the media

Based on this, the dynamic U -value of the porous media can be determined easily. By modifying the material property in the design tools such as TRNSYS, it is possible to perform the energy analysis for the building that is installed with dynamic insulation elements.

5.5. Available experimental procedure to assess element performances

Many experiments and full-scale field trials have been reported in the literature over the years, but these have not led to development of a standard method of measuring dynamic thermal resistance or PM₁₀ filtration.

To measure the thermal performance of a dynamic insulation element, a special test cell needs to be designed and constructed, such as

1. Hot box chamber, an insulated box with a dimension of 0.5m×0.5m×0.5m. (Crowther, 1995).
2. PASSYS test cell in UK (Baker, 2003), which is highly insulated box, with a dimension of 5.0m×2.75m×2.76m;
3. PASLINK test cell in Greece (Dimoudi et al, 2004), an insulated box of 5 m×3.8m×3.6m.

The dimension of the hot box by Crowther (1995) limits its test capability. Comparatively, the advantage of adopting the test cell of PASSYS or PASLINK is that they are able to measure the thermal performance of full scaled dynamic insulation components under real outdoor climate conditions.

5.6. Availability of measured performances

Baker (2003) carried out an extensive experimental work to study the impact of ventilation rate and solar radiation; etc on the performance of a dynamic wall.

Dimoudi et al (2004) reported the hourly variation of internal-external surface temperature difference and conductive heat flux at the internal surface, under real outdoor conditions during a one day period. The results show that depending on the ambient conditions during the day, the operation of the dynamic insulation may change from contra-flux mode to pro-flux mode.

The experimental work of Crowther (1995) focused on the influence of the inner and outer air film on the thermal performance of the dynamic insulation. The results show that heat

resistance of the inner surface is determined by natural convection and radiation, while the heat resistance of the outer surface is determined primarily by radiation.

The Environmental Building Partnership Ltd (EBP) has taken the important step of developing a prototype modular DI product, the Energyflo™ cell (EBP, 2005), for mainstream building construction. The product is a versatile replacement for conventional thermal insulation in buildings, and can be used in virtually any type, shape, form, size or age of building. It is currently being trialed in a new residential housing development by CALA Homes (East) Ltd in the City of Edinburgh, Scotland. This is the world's first DBB and features a dynamic breathing roof forming part of the air handling and *Mechanical Ventilation Heat Recovery* (MVHR) system. This RD&D project, which is partly funded by the UK Carbon Trust and Industry, will monitor and report on the construction, commissioning and post-occupancy phases during the life of Annex 44, thus providing a valuable, state-of-the-art exemplar of DI and its application.

5.7. Availability of simulated performances

So far, efforts have been made to assure that air uniformly transfers through the wall, and to prevent thermal edge effects. Therefore a one-dimensional heat transfer model, especially a steady-state model (equation (1)), is generally used for its thermal performance analysis. An analytical solution can be directly obtained because of the constant velocity value used.

Furthermore, under steady state conditions, if considering the influence of air film thermal resistance inside and outside the dynamic insulated wall, the temperature of internal surface of dynamic insulated wall can be calculated (Taylor and Imbabi, 1997, Gan, 2000)

$$\frac{T_i - T_s}{T_i - T_0} = \frac{R_i \exp(Pe)}{R_i \exp(Pe) + \frac{\exp(Pe) - 1}{kPe/L} + R_0} \quad (6)$$

T_s - Temperature of inner surface of dynamic wall (K)

R_i - Local thermal resistance of inner air film (m^2K/W)

R_0 - Local thermal resistance of outer air film (m^2K/W)

Therefore the inner surface temperature decreases with the airflow rate.

Corresponding with this theory, results obtained in the above investigations concerning the performance of dynamic insulation include:

1. When calculating the inner or outer surface temperature, the suitable boundary condition is that the conductive heat flux at the wall surface, rather than the net heat flux, is equal to the flux incident on the wall from the environment;
2. In the assessment of heat loss through dynamic insulation over the static equivalent, the influence of both inner and outer surface air films can be neglected;
3. The air film influences the inner and outer surface temperatures, so it will impact the thermal comfort of occupants in the room.

For the unsteady situation, Kraiti (1994) derived an analytical solution, assuming that the indoor and outdoor temperature follows a sinusoidal law, i.e.:

$$T = T_m + A_m \operatorname{Re}(e^{j\omega_n t}) \quad (7)$$

T_m - The average temperature (K)

A_m - The amplitude of temperature variation (K)

ω_n - The frequency (1/s).

An investigation was conducted based on the analytical solution of equation (7) to evaluate the thermal performance of dynamic insulation system integrated with a whole building. The criteria “wall efficiency” was defined using the ratio of conductive heat loss at internal surface of insulation without and with ventilation. The change of wall efficiency in a day was presented.

Analytical solutions are based on the condition that air velocity through the wall is constant. To consider the variation of air velocity in the wall, a numerical approach is needed, and two dimensional or three dimensional air flow and heat transfer should be adopted in the simulation.

A two dimensional numerical model has been presented by Qiu and Haghghat (2005) to study the heat exchange performance in the breathing walls. Because of the low velocity in the wall, the air flow is considered to be in the Darcy’s regime. A microscopic point of view is adopted to describe the heat exchange process between air and solid phase. Governing equations are set up to model the conduction in the solid matrix, conduction as well as convection in the air phase, in a representative elementary volume. The overall energy equation is derived by using one medium treatment and volume average method. Simulation is performed under two kinds of air flow path configurations: the straight through configuration and low inlet-high outlet or high inlet-low outlet configuration. To find out the key factors influencing the heat exchange performance, a parameter study has been carried out. Variables in the study include air flow rate, infiltration path length and configuration, porosity of the material, indoor and outdoor temperature difference, as well as convective heat transfer coefficient of the wall. The results of the on going research show that

1. Heat exchange in the wall mainly locally occurs in the area near air inlet and outlet;
2. The air flow rate is the first important factor for the heat exchange performance in the exterior wall;
3. The air flow path length and configuration also have obvious impact to the heat exchange performance;
4. Influence of the porosity is limited, thus high porosity material might be used in the building design if more fresh air is preferred;
5. The indoor and outdoor temperature difference does not have a significant effect, so it is with the variation of the convective heat transfer coefficient.

5.8. “Claimed” benefits

Concerning energy consumption, the following benefits are claimed for the application of dynamic insulation:

1. Less energy is required to maintain an indoor air temperature, thus the operating costs for space heating and cooling are reduced.
 - Simulation (Krarti, 1994) of a room with a dynamic insulated wall showed that the overall energy saving may reach 20%, while the simulation results by Baily (1987) point out the energy saving during a heating period vary from 7% to 14%, without any additional equipment such as a heat pump.

- The product *Energyflo*TM cell is also claimed to reduce the required heating and cooling load by 10%, compared to the Scotland building regulation standard.
2. As low heat loss can be achieved by using a thin dynamic insulated wall, it is possible to avoid the need to use thick wall construction to meet the building regulations to reduce construction cost.
 3. By using dynamic insulation, the wall becomes the ventilation source, thus saving the cost of supplying and installing ventilation ducts.
 4. As dynamic insulation is generally working in contra-flux mode, it will also prevent the water vapor getting into the wall from the interior, therefore reducing the risk of condensation in the wall.

Meanwhile, working as an air filter, dynamic insulation can remove airborne particulate pollution from the ventilation air. Therefore better indoor air quality could be provided for the building occupant.

5.9. Future perspectives

Research on dynamic insulation until now focuses on heat transfer process and focuses have been on its ability to reduce energy consumption. For the purpose of having this technique implemented in the real buildings, future work needs to be performed at least on the following aspects:

1. Moisture exists in the real environment and will affect the performance of dynamic insulated walls. Taking advantage of appropriate air flowing through the wall, dynamic insulation will have better performance in reducing the risk of condensation, compared with the conventional wall. However, under some conditions, such as the sun shining on wet timber cladding, condensation may occur in the dynamic insulated wall (Taylor and Imbabi, 1998). Therefore, research is needed to evaluate the thermal performance of the dynamic insulation by using a couple heat and moisture transfer model, and to find out the appropriate method to avoid the occurrence of condensation.
2. So far, the influence of long wave radiation has not been considered in the simulation. Therefore a comprehensive heat transfer analysis combining conduction, convection, as well as radiation is needed, especially considering the radiation between different layers.
3. To assure that the dynamic insulation operating in contra-flux mode, de-pressurization of the building is needed. The pressure drop must be no greater than 5-10Pa, otherwise the occupants will find it difficult to open doors and windows. Therefore the control strategy for air supply needs to be studied and optimized to minimize the electricity consumption. Dimoudi et al (2004) concluded that to keep the indoor environment under adequate de-pressurization, the fan should be operated with variable speed. Thus a control strategy is needed for the application of dynamic insulation in real environmental situations.

5.10. Barriers to application

Though theoretical analysis and experimental tests have been conducted to evaluate the performance of dynamic insulation, and the possibility of its implementation has been discussed, there are still problems in the application of dynamic insulation. Specific barriers are as follows:

1. Technical problems exist concerning moisture transport in the insulation. Therefore it lacks the effective way to avoid possible condensation in the insulation under certain conditions.
2. The guideline for dynamic insulated wall design is not well developed. Suggestions should be made concerning the aspects such as: what is the suitable thickness for each sub-layer, what kind of material is more appropriate, and how to determine the dimension of an inlet crack.
3. There is a conflict between the minimization of heat loss by reducing air flow rate, and the removal of water vapor and other indoor pollutants by increasing air flow rate. Thus the air flow rate should be optimized.
4. The dynamic insulation has not been integrated in the commonly used building design tools such as DOE2, EnergyPlus, Esp-r, and TRNSYS.
5. The impacts of dynamic insulation on the requirements of building regulations and standards have not been investigated.
6. For the application of dynamic insulation, other parts of the building need to be well insulated, this may bring difficulties in construction process and increase the construction cost.
7. The property of materials concerning the air permeability and water vapor permeability is not accessible to some designers.
8. Building designers are still unfamiliar with the concept of dynamic insulation. It may take a long time for them to recognize the advantage of this technique and implementing it in their designs.

5.11. Limitations

Dynamic insulation is a possible approach to supply a good indoor environment with less energy consumption. However, limitations exist concerning its performances. They are as follows:

1. Though it is claimed the dynamic insulation can reduce the conductive heat loss, convective heat loss increases with the air flow rate, and additional electrical energy may be required to drive fans. Thus the overall energy saving is not very significant (generally lower than 10%). This might make this technique less attractive.
2. Dynamic insulation can work as an air filter. However, dust and other particles trapped in the insulation may prompt the growth of bacteria. This might bring potential problem to the occupants' health. Meanwhile, it is pointed that dynamic insulation may not be effective to remove chemical pollutants (Taylor and Imbabi, 1998)

5.12. Open questions and future research work to be done

Though the concept has been developed for more than 30 years, dynamic insulation has not really been implemented in building design, because of its specific problems and uncertainties. The following aspects will significantly affect the feasible application of this technique in the future:

1. With air transferring through the dynamic insulated wall, the temperature distribution changes. One important aspect is that the interior surface temperature will deviate from that without ventilation. In heating season, the interior surface temperature decreases with the air flow rate. A CFD simulation shows that this may affect the thermal comfort of occupants in the room (Gan, 2000). However, there is no further report on this topic. For the application of dynamic insulation, investigation should be preceded on this aspect, adopting the approach of:
 - Numerical simulation, especially for the configuration that air does not enter the room uniformly through vast area of the internal surface of the wall, but through vents on some part of the wall (such as the prototype dynamic insulated wall by Baker, 2003);
 - Experiment work to find its influence on thermal comfort.
2. As the overall energy saving by dynamic insulation is only about 10%, it is less attractive if a fan is operating all the time. One option for this problem is to combine the dynamic insulation with natural ventilation, or mixed ventilation, taking the advantage of pressure gradient by wind and stack effect. However, the control strategy will be more complicated if so. Further research is needed to find an appropriate design and control scheme for this topic.
3. In the dynamic insulation implementation, one important consideration is to assure the one dimensional air flow through the wall. However, from the point of view of heat exchange in the insulation, the low inlet-high outlet or high inlet-low outlet configuration (Buchanan and Sherman, 2000) is more preferable. Meanwhile, by using this kind of configuration, temperature change locally occurs in the place where air enter the room, and can be ignored on most parts of the wall. Therefore it will be promising to find out new design protocol to make the air come into and exit the insulation from different horizontal places.

5.13 References

- Annex 44 A3. Dynamic Insulation. Annex 44 State-of-the-Art Working Report Pt. A3, (www.civil.aau.dk/Annex44) contains a complete and comprehensive list of references on DI (2006).*
- Baily N R. 1987. Dynamic insulation systems and energy conservation in buildings. ASHRAE Transactions, n93, pt1, p447-466*
- Baker P H. 2003. The thermal performance of a prototype dynamically insulated wall. Building Services Engineering Research and Technology, v 24, n 1, p25-34*
- Bartussek H, Poren-luftung (Porous ceilings). Osterreichisches Kuratorium fur Landtechnik, Vienna (1981).*
- Buchanan C R, Sherman M H. 2000. A mathematical model for infiltration heat recovery. Lawrence Berkeley Laboratory, LBNL-44294*
- Chebil S, Galanis N, Zmeureanu R. 2003. Computer simulation of thermal impact of air infiltration through multilayered exterior walls. Eighth IBPSA Conference, Eindhoven, Netherlands*
- Crowther D R G. 1995. PhD thesis, University of Cambridge, UK*
- Dalehaug A. 1993. Dynamic insulation in walls. Research Report No. 53. Hokkaido Prefectural Cold Region Housing and Urban Research Institute, Japan*
- Dimouli A, Androutsopoulos A, Lykoulis S. 2004. Experimental work on a linked, dynamic and ventilated, wall component. Energy and Buildings, v36, n5, p443-453*
- Environmental Building Partnership Ltd, Energyflo™ cell and the dynamic breathing building (DBB) system, EBP Tech. Bulletin No. 1 (2005).*
- Environmental Building Partnership Ltd, Energyflo™ cell - thermal performance, EBP Tech. Bulletin No. 2 (2005).*
- Etheridge D W, Zhang J J. 1998. Dynamic insulation and natural ventilation: feasibility study. Building Services Engineering Research & Technology, v19, n4, p203-212*
- Gan G. 2000. Numerical evaluation of thermal comfort in rooms with dynamic insulation. Building and Environment, v35, n5, p 445-453*
- Imbabi M S, and A D Peacock, Allowing buildings to breathe, Sovereign Publications, p85-95 (2004).*
- Imbabi M S, Modular breathing panels for energy efficient, healthy building construction, Renewable Energy, Vol. 31, Issue 5, p 729-738 (2006).*
- Imbabi M S, Full-scale evaluation of energy use and emissions reduction of a dynamic*

- breathing building, Proceedings of WREC-IX, Florence, 19-25 August, (2006).*
- Krarti M. 1994. Effect of airflow on heat transfer in walls. Journal of Solar Energy, v116, n1, p35-42*
- Qiu K, Haghightat F. 2005. Assessment of Impact of Building Envelope Porosity on energy. Ninth IBPSA Conference, Montreal, Canada*
- Straube, J F and V Acahrya, Indoor air quality, healthy buildings, and breathing walls, Building Engineering Group, Civil Engineering Department, University of Waterloo, Ontario, CA (2000).*
- Taylor B J, Cawthorne D A, Imbabi M S. 1996. Analytical investigation of the steady-state behaviour of dynamic and diffusive building envelopes. Building and Environment, v31, n6, p519-525*
- Taylor B J, Imbabi M S. 1998. Application of dynamic insulation in buildings. Renewable Energy, v15, n1-4 pt1, p37-382*
- Taylor B J, Webster R, Imbabi M S. 1999. The building envelope as an air filter. Building and Environment, v34, n3, p353-361*
- Taylor B J, and M S Imbabi, The effect of air film thermal resistance on the behavior of dynamic insulation, Building & Environment, Vol. 32(5), p397-404 (1997).*
- Taylor B J and M S Imbabi, Dynamic insulation in multi-storey buildings, Proc. CIBSE A, Building Services Engineering Research & Technology (BSERT), 20(4), p175-180 (2000).*
- Taylor B J and M S Imbabi, Environmental design using dynamic insulation, ASHRAE Transactions, Vol. 106(1), p15-28 (2000).*
- Wallenten P, OPTIMAT field measurements of dynamic insulation. Proceedings of the 3rd Symposium Building Physics in Nordic Countries, Vol. 1, p243-251, Copenhagen, 13-15 September (1993).*
- Wong J M, F P Glasser, and M S Imbabi, Breathable concrete for low energy buildings, Proceedings of WREC2005, 22-27 May (2005).*

Chapter 6 Phase Change Materials (PCM)

6.1. Component description and example of existing applications

The use of PCM (Phase Change Materials) in the construction field aims to be a solution for the control of thermal flows and the exploiting solar energy by using its enormous capacity for accumulating heat around temperatures close to its melting point. In effect, by exploiting their latent fusion heat, and in smaller part, their specific heat, these materials act as heat accumulators; absorbing and discharging heat keeping their temperature unaltered and thus avoiding the overheating of the elements they are contained in.

Latent thermal-storage media are products that within a limited temperature range around their melting point (i.e. at the phase change from a solid to a liquid state or vice versa) are able to absorb large quantities of thermal energy without undergoing a rise in temperature themselves. In building construction, this property can be exploited as a means of heating or cooling without the use of additional energy. Within the relevant temperature range, the thermal storage capacity is much greater than that of heavy, solid building materials like concrete or brickwork. For that reason, latent thermal-storage media are commonly used in lightweight forms of construction.

There are many different kind of different application, within the building fields, where it is possible using the heat storage capacity of PCM. The whole applications use the PCM materials for increase the thermal inertia or the thermal storage capacity of the components, for improve the use of solar and natural energy, increase the internal comfort of the building, for reduce the using of heating and cooling system that use not renewable energy.

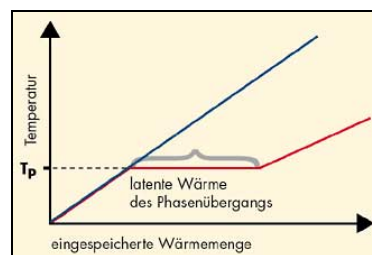

Fig. 6.1: Graphic temperature-time of a PCM material (red line) and a normal material without change phase (blue line)

A large number of organic and inorganic substances are known to melt with a high heat fusion in any requires temperature range. Each kind of different phase change material has different thermodynamic, kinetic, chemical proprieties, and the choice of the suit PCM is made considering these proprieties, and economical considerations.

6.1.1. Classification of PCM

PCMs are categorized as Organic, Inorganic and Eutectic materials.

Organic materials are further described as paraffin and non-paraffins. Organic materials include congruent melting, self-nucleation and usually non-corrosiveness to the container material. Commonly used organic PCMs for heating and cooling in buildings falling in the range of 20–32 °C with their melting point and latent heat of fusion are listed in Table 6.1.

Inorganic materials are further classified as salt hydrate and metallics. Inorganic compounds have a high latent heat per unit mass and volumes are low in cost in comparison to organic compounds and are non-flammable. However they suffer from decomposition and supercooling which further can affect their phase change properties. The commonly used inorganic PCMs in the range of 20–32°C are listed in Table 6.2.

An eutectic is a minimum-melting composition of two or more components, each of which melts and freeze congruently forming a mixture of the component crystals during crystallization. Commonly used Organic–Organic, Organic–Inorganic and Inorganic–Inorganic eutectics PCMs used for building applications are listed in Table 6.3. For latent heat storage commercial grade (CG) PCMs are preferred due to their large scale availability and low cost. The thermophysical properties/behaviour of CG materials in general was found to be very much different than those quoted in the literature for laboratory grade (LG) materials therefore, it becomes important to verify the melting temperature, latent heat of fusion and specific heat of CG latent heat storage materials. A list of commercial PCMs, which can be used in the buildings for thermal storage (available in the International market) is given in Table 6.4.

Table 6.1: Organic substances with potential use as PCM

Compound	Melting point [°C]	Heat of fusion [kJ/kg]
Butyl stearate	19	140
Paraffin C16–C18	20-22	152
Capric–Lauric acid	21	143
Dimethyl sabacate	21	120
Polyglycol E 600	22	127.2
Paraffin C13–C24	22-24	189
(34% Mistiric acid+66% Capric acid)	24	147.7
1-Dodecanol	26	200
Paraffin C18 (45–55%)	28	244
Vinyl stearate	27-29	122
Capric acid	32	152.7

Table 6.2: Inorganic substances with potential use as PCM

Compound	Melting point [°C]	Heat of fusion [kJ/kg]
KF· 4H ₂ O	18.5	231
Mn(NO ₃) ₂ ·6H ₂ O	25.8	125.9
CaCl ₂ · 6H ₂ O	29	190.8
LiNO ₃ ·3H ₂ O	30	296
Na ₂ SO ₄ ·10H ₂ O	32	251

Table 6.3: Inorganic eutectics with potential use as PCM

Compound	Melting point [°C]	Heat of fusion [kJ/kg]
66.6% CaCl ₂ · 6H ₂ O+33.3% MgCl ₂ · 6H ₂ O	25	127
48% CaCl ₂ +4.3% NaCl+0.4% KCl+47.3% H ₂ O	26.8	188
47% Ca(NO ₃) ₂ · 4H ₂ O+53% Mg(NO ₃) ₂ · 6H ₂ O	30	136
60% Na(CH ₃ COO) · 3H ₂ O+40% CO(NH ₂) ₂	30	200.5

Table 6.4: Commercial PCMs available in the International market

PCM name	Type of product	Melting point [°C]	Heat of fusion [kJ/kg]	Source
RT 20	Paraffin	22	172	Rubitherm GmbH
Climsel C23	Salt hydrate	23	148	Climator
ClimselC24	Salt hydrate	24	216	Climator
RT 26	Paraffin	25	131	Rubitherm GmbH
RT 25	Paraffin	26	232	Rubitherm GmbH
STL 27	Salt hydrate	27	213	Mitsubishi chemical
S27	Salt hydrate	27	207	Cristopia
RT 30	Paraffin	28	206	Rubitherm GmbH
RT 27	Paraffin	28	179	Rubitherm GmbH
TH 29	Salt hydrate	29	188	TEAP
Climsel C32	Salt hydrate	32	212	Climator
RT32	Paraffin	31	130	Rubitherm GmbH

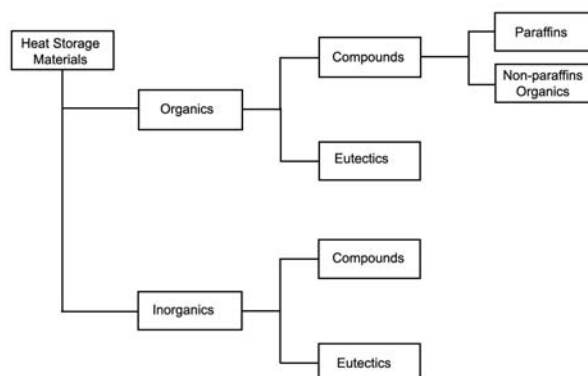

Fig. 2: Families of phase change heat storage materials.

6.1.2. Properties of PCMs

The PCM to be used in the design of thermal storage system should possess desirable thermophysical, kinetic and chemical properties, which are recommended as follows

6.1.2.1. Thermophysical properties

- Melting temperature in the desired operating temperature range.
- High latent heat of fusion per unit volume so that the required volume of the container to store a given amount of energy is less.
- High specific heat to provide additional significant sensible heat storage.
- High thermal conductivity of both solid and liquid phases to assist the charging and discharging energy of the storage system.
- Small volume change on phase transformation and small vapour pressure at operating temperature to reduce the containment problem.
- Congruent melting of the phase change material for a constant storage capacity of the material with each freezing/melting cycle.

6.1.2.2. Kinetic properties

- High nucleation rate to avoid super cooling of the liquid phase.
- High rate of crystal growth, so that the system can meet demand of heat recovery from the storage system.

6.1.2.3. Chemical properties

- Complete reversible freeze/melt cycle.
- No degradation after a large number of freeze/melt cycle.
- No corrosiveness to the construction materials.
- Non-toxic, non-flammable and non-explosive material for safety.

6.1.3. Wall applications

Especially in warm climates, houses are frequently built using lightweight construction materials, which do not provide sufficient thermal mass for the storage of heat. These houses are therefore overheated during daytime, but rapidly cool down at night. In order to compensate for these fluctuations in temperature, the air conditioning is used during the day and a heating system in the evening.

A PCM layer can be placed within wall constructions to increase the thermal mass of the house. This will ensure that the thermal energy created by solar radiation is stored in the walls during daytime and then released to the room, when the ambient temperature has dropped or released outside the building. As a result, the room temperature will, in general, be more comfortable and less varied, and energy consumption for both air conditioning and heating will decrease.

In the market there are many solutions of wall whit using of PCM layer, which are described as follow.

In this technological solution, a layer of salt crystals stores the heat of the incoming sunlight and transfers this to the interior if required. A prismatic glass that is also included lets the incoming sunlight pass through only if it is at a shallow irradiation angle (i.e. in winter), thus protecting the interior from overheating. In this way, a component is created that not only uses and stores the power of the sun, but simultaneously provides protection against it. Or, to put it in a nutshell: a component that stores, heats and cools. In the same place, at the right time.

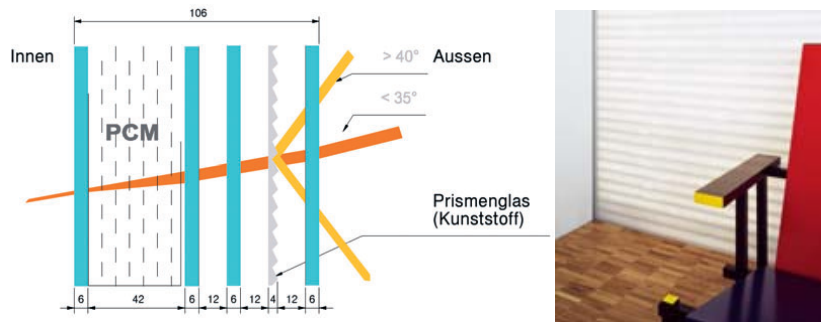

Fig. 6.3: Glass façade with PCM, Home for seniors in Domat/Ems (Glassx).

Thin-layered latent heat fibre boards or a bulk material, such as latent heat granulate, can be placed within wall constructions to increase the thermal mass of the house. This will ensure that the thermal energy created by solar radiation is stored in the walls during daytime and then released to the room in the evening, when the ambient temperature has dropped. As a result, the room temperature will, in general, be more comfortable and less varied, and energy consumption for both air conditioning and heating will decrease.

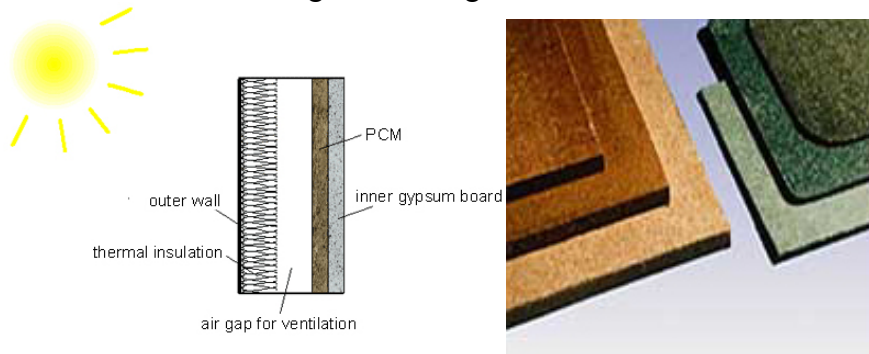

Fig. 6.4: stratification of a wall with inserting PCM layer (Rubitherm GmbH)

The PCM plaster is applied like conventional plaster. The thinness of the coating and its low weight combined with a high thermal storage capacity are particularly advantageous in renovation projects. The capillary tube mats, which are visible on the ceiling, can be connected to any type of cooling source, such as an evaporative cooling tower or underground water.

The closely spaced capillary tubes, through which water is pumped, provide very good thermal coupling to the surrounding plaster. Thus, the ceiling can be cooled quickly, even if the temperature differences are only small. This feature, and the thinness of the plaster coating enable the system to react quickly compared to e.g. conventional cooling ceilings, despite the high thermal storage capacity of PCM



Fig.6.5: PCM plaster with integrated an hydraulic system (BASF).

6.1.4. Underfloor applications

Even today, refurbishment schemes account for a significant proportion of construction activity in the commercial sector (office and industrial buildings), and the increasing shortage of development sites in urban centers looks set to consolidate this trend in future. Any breakthrough in the application of sustainable energy systems to both retrofit and new-build schemes will depend on a wider use of renewable energy sources in the operation of building technologies, particularly heating and cooling. Both the enhanced technical installation requirements of workplaces and the increased use of fully glazed facades favored by contemporary architecture have forced up the internal and external thermal loads in modern office buildings. As a result, such facilities now require cooling for much of the year. To prevent an unacceptable rise in the indoor temperature, thermal gains have to be removed from the building interior.

The internal surfaces when are directly irradiated, incline, in particular if build with lightweight technologies, to be overheated. The application of PCM in floor stratifications or in underfloor heating and cooling systems can avoid or reduce this problem, stabilize the surface temperature in a range close to the point fusion temperature. Also if the air temperature is higher then the temperature of the surface and the PCM, these absorb heat form the internal environment, lower the internal temperature of air. The energy that is store in the day can be easily removed, if necessary, with a hydraulic system, or for used for heat the building in the night. In the winter the PCM avoid or reduce the temperature oscillation due to switch of the heating system and if directly irradiated by sunlight, exploit the solar energy for heating.

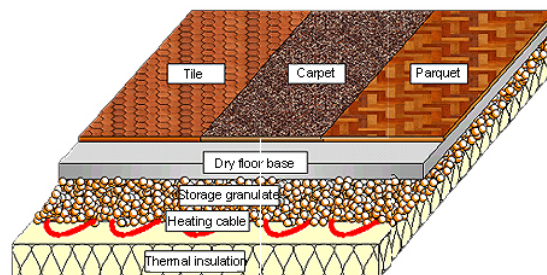

fig.6.6: Underfloor heating and cooling system with integrate a heat storage of PCM granulate (Rubitherm GmbH).

Another application of PCM in building components is in a electric floor-heating system. In this case the floor-heating system stores heat at night, when electricity rates are low, and

discharges it during the day. This system can reduce energy costs by about 30% compared with systems that use electricity at regular rates. Electricity costs can be reduced a further 15% through use of a system equipped with microcomputer control. Also the heat storage capacity of PCM, improve the internal comfort reducing the surface temperature oscillation.

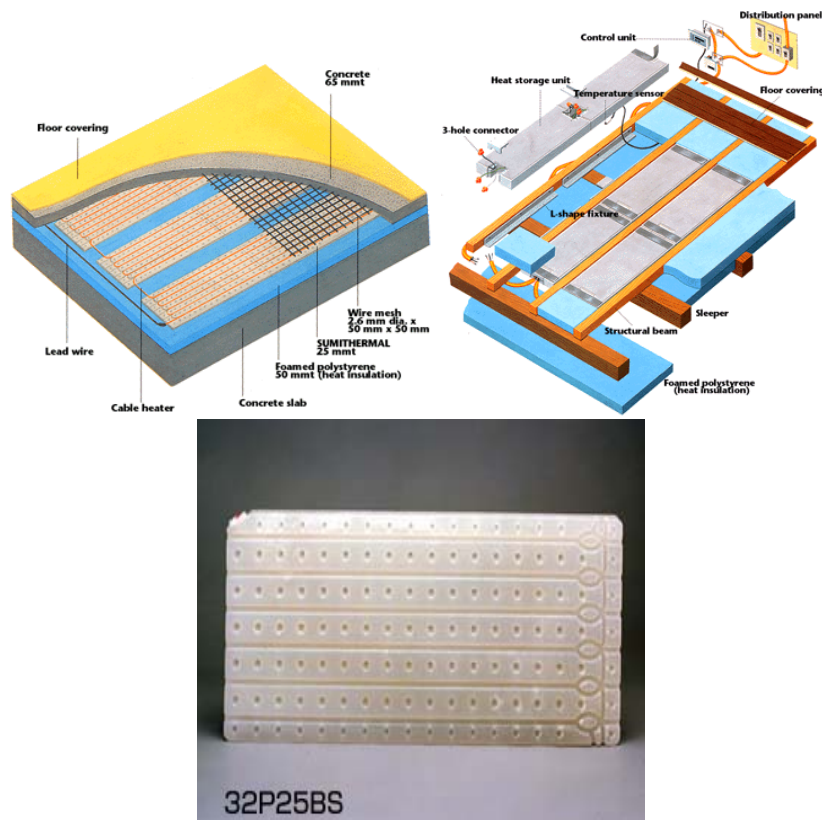

Fig. 6.7: electric floor-heating system utilising heat storage unit of PCM (Sumika)

6.1.5. Thermal Storage Unit and air exchanger applications

Many people wish to have a heating system with low energy consumption and/or utilising regenerative energy. This requires a large heat storage capacity to achieve good results. With the integration of a suitable latent heat storage material or so-called phase change material (PCM), compact storage units with high heat storage capacity will be feasible for many applications in the heating and ventilation industry. The crucial question however, is under which conditions a latent heat storage unit provides an advantage over traditional water storage units.

Many heat storage units, like conventional hot water storage units, use sensible heat only, i.e. the temperature change of water. In a latent heat storage unit, the sensible heat is augmented by the latent heat (melting enthalpy) of the phase change material. This latent heat is added when the material melts and released when the material congeals.

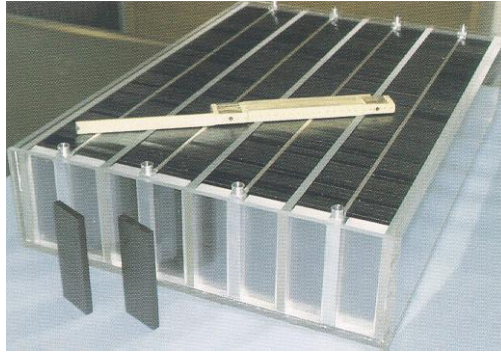

Fig. 6.8: Heat storage system (ZAE-Bayern).

Air heating systems are frequently used in industrial buildings, offices, hotels etc., and are also becoming increasingly popular for private homes, especially where, as a result of improved insulation, the majority of heat is required to compensate for ventilation heat losses rather than heat losses through walls and windows. Low energy consumption homes are a typical example, where an air heating system may be utilised. The combined use of solar energy, other regenerative energy sources or heat pumps using low tariff night electricity, together with a latent heat storage unit for air heating systems provides an economic and energy efficient heating method.

The form of the latent heat storage material, for example granulate or plates, allows the material to be placed in any conceivable container and ensures a large heat transfer surface area, but low pressure losses. The heat storage capacity is 3 to 5 times higher than that of alternative thermal storage materials such as stone, gravel or sand. Consequently, the latent heat storage unit is relatively lightweight and requires limited space, thus reducing building costs.

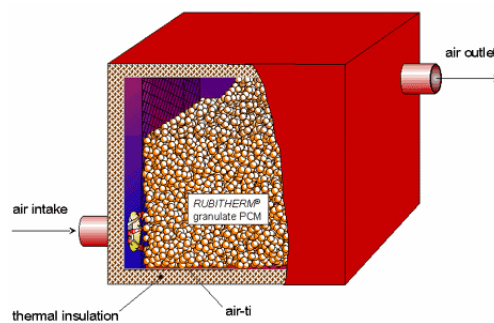

fig. 6.9 air heating system with granulate PCM (Rubitherm GmbH).

Low energy consumption homes meet strict requirements for the economical and efficient use of energy. A latent heat storage unit integrated into home hot water systems, thus providing interior heating and hot water supply, results in a considerable reduction of energy consumption and cost, as well as in reduced pollutant emissions

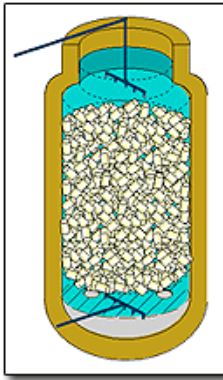

fig. 6.10: heat storage unit system (Rubitherm GmbH).

6.2. Working principles

PCM are “latent” heat storage materials. They use chemical bonds to store and release the heat. The thermal energy transfer occurs when a material changes from solid to liquid, or liquid to solid. This is called a change in state or phase. PCM, having melting temperature between 20 and 36 °C, were used/recommended for thermal storage in conjunction with both passive storage and active solar storage for heating and cooling in buildings. A large number of PCMs are known to melt with a heat of fusion in the required range. When a solid PCM is heated up and reaches its melting point, it goes through a phase change, from solid to liquid. During this process the material absorbs a certain amount of heat, known as melting enthalpy. Despite the heat input, the temperature of the material stays at a relatively constant temperature, even though phase change is taking place. We thus speak of latent (concealed) heat having been taken up by the material. Equally, when the phase change process is reversed, that is from liquid to solid, the stored latent heat is released, again at a nearly constant temperature.

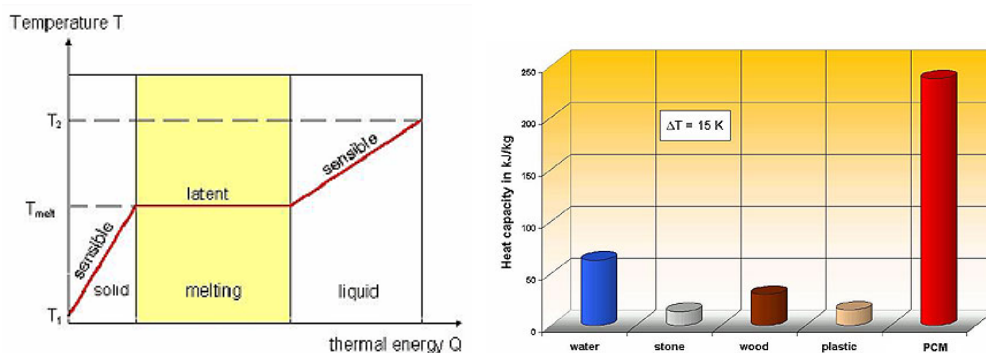

fig. 6.10: Behaviour of a Phase Change Material and heat capacity comparison

Unlike sensible storage materials, such as water, masonry or rocks, PCM stores much more heat per unit volume and another key advantage with the use of a PCM is that heat storage and its recovery occurs isothermally, which makes them ideal for space heating/cooling applications. The advantage of a PCM is the use of the latent heat which is available during the phase change process. A smaller amount of the heat storage capacity (depending on the temperature difference) consists of sensible heat. For example the specific heat capacity of latent heat paraffins is about 2,1 kJ/(kg·K). Their melt enthalpy lies between 120 and 160

kJ/kg, which is very high for organic materials. The combination of these two values results in an excellent energy storage density. Consequently, latent heat paraffins/waxes offer four to five times higher heat capacity by volume or mass, than water at low operating temperature differences.

6.2.1. Behaviour of a PCM inserting in a dry wall façade

The aim of application of a PCM layer in a external wall is the control of the heat flux, the temperature of the components and internal environment, and the utilising of solar energy for heating the building. The control of the heat flux is made changing the thermal inertia and storage capacity of these components, without an important change of the thermal resistance of the wall. The elevate thermal inertia in a range of temperature close to the point of fusion of the PCM reduce the temperature oscillation of the components, avoiding the overheating, the temperature and flux peak, typical in the day and night in the summer seasons. Also the effect of the application of the PCM layer is a shifting of the flux peak, in the cool hours of the day.

In the winter is possible utilising the PCM as an solar heating storage system to capture the solar energy and release the heat in the internal environment of the building, reducing the using of the heating system and the not renewable energy.

Typical components in a external façade containing PCM are:

- External sub-system: it affects the wall's external appearance (and the external building appearance); thanks to its optical and thermal properties, it establishes the ratio of the incident solar radiation that is absorbed or reflected; an insulating layer could belong to the external sub-system;
- Intermediate sub-system: it is made up of a layer of PCM and, an insulating layer (whether or not it is used for the external sub-system);
- Internal sub-system: it determines the internal surface temperature and, consequently, it controls the average radiant temperature in the internal environment; it has an important role in obtaining comfort conditions.

In the warm day of the year, typical of the summer seasons, when there are problems of flux control the application of a PCM layer, can reduce the load and the flux peak. In fact during the day in the place where the temperature outside is very warm and the external surfaces is directly irradiated by sunlight, the façade is overheated and the thermal flux have the peak. The PCM layer store the thermal energy, changing its phase from solid to liquid, keeping its temperature constant close to the point of fusion. In this way there are a control of the heat flux and the thermal load of the building. Also the temperatures of the components, in particular of the internal surfaces, are lower than in a normal wall without PCM.

In the night when the temperature is lower then the temperature of fusion, the PCM to make solid. In this process the phase change material release the energy stored in the day. Part of this energy is released outside and a part inside the building. The choice of a right stratification concurs to manage this energy.

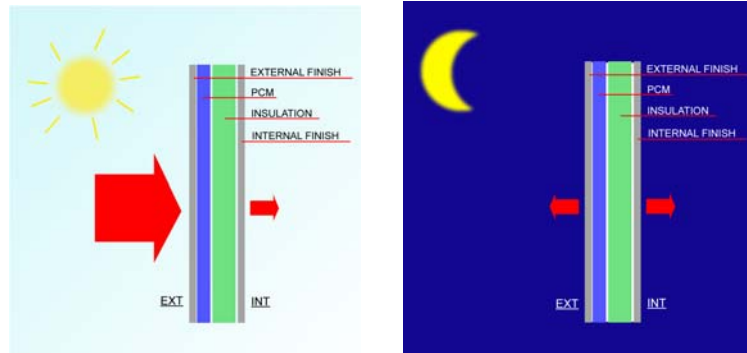

Fig.6.11: Behaviour of a wall with inserting a PCM layer during the day and the night

6.2.2. Behaviour of a PCM inserting in underfloor heating and cooling system

One of the possible uses that was imagined for the PCM blanket is an underfloor application, integrated to a radiant heating or cooling system. In this sense, the blanket would replace the thermal mass traditionally obtained through concrete elements, giving the added benefit of being able to design both the operating temperature of the system and its thermal capacity according to the specific situation.

The technical solution is composed by two layers of the PCM blanket with the water pipes embedded between them in order to enhance heat exchange between the surface of the pipes and the PCM contained in the pouches. The upper surface is then made smooth trough a thin self-levelling screed, where the floor material can be laid.

The basic idea was to maintain the floor at a more or less constant temperature: that of the melting point of PCM contained in the blanket. In summer, the floor heats up, because of the radiation from the sun entering the windows, but when it reaches the melting temperature the phase change process begins. Then, the energy gained from the sun is used in latent form, while the temperature of the PCM layer remains constant. If the melting temperature is accurately chosen, during the phase change process the floor works as a radiant surface at a comfortable temperature for the users of the building. Most of the energy coming from the sun is thus used for PCM melting instead of increasing the air temperature inside the building. When PCM's are completely melted, or night has fallen, cool water circulating in the floor is used to activate the inverse process of solidification (discharging of the PCM layer by taking latent heat away). In this way, the PCM element is ready for another storage cycle, be it the same day or the next morning.

If the melting temperature is well chosen, a similar strategy can be used also in winter, with hot water used to warm up PCM's, which then release heat to the internal environment. In both seasons, anyway, it is clear that the idea is to integrate closely the PCM element and the heating / cooling system, in order to reduce its peak load and the time it needs to work: the PCM blanket helps the radiant system work less

6.2.3. Behaviour of an air exchanger with PCM

In modern buildings greater use of it is increasing the risk of overheating in the summer. The application of a air exchanger that us a latent thermal mass provides a low cost passive environmental solution to avoid the need to resort to air conditioning. This application uses

the thermal mass of a building to store cooling introduced at night by circulating relatively cool ambient air through the building - “night cooling”. This stored cooling is then released by circulating air the next day to offset heat gains and limit internal temperature rises.

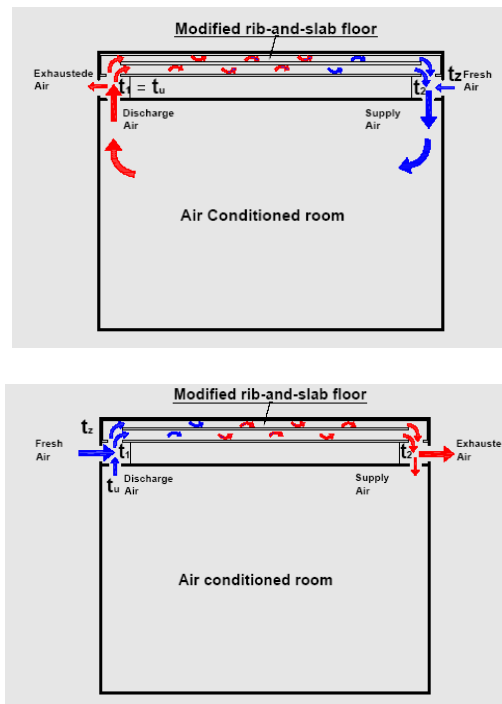

fig. 6.12: Air conditioning system based on thermal energy storage in building structure, night and day behaviour.

6.3. Application field

The development of an energy storage system may be one of the solutions to the problem when electricity supply and demand are out of phase. A building integrated with distributed thermal storage materials could shift most of the load coming from residential air conditioners from peak to off peak time periods. As a result, capital investment in peak power generation equipment could be greatly reduced for power utilities and then could be reflected in less expensive service to customers. Where power utilities are offering time of day rates, building integrated thermal storage would enable customers to take advantage of lower utility rates during off peak hours. There are some studies that have examined the shifting of heating and cooling loads to off peak times of the electrical utility but did not reach general conclusions regarding optimal PCM properties. Their analysis looked at potential applications of PCM wallboard as a load management device for passive solar applications and found it saved energy with reasonable pay back time periods.

Peippo et al., have shown that a 120 m² house in Madison, Wisconsin (43°N), could save up to 4 GJ a year (or 15% of the annual energy cost). Also, they have concluded that the optimal diurnal heat storage occurs with a melt temperature 1–3 °C above average room temperature. Claims are made that PCM wallboards could save up to 20% of residential house space conditioning cost.

6.4. Available design tools

In order to have calculation methods which can be useful during a process which regards the design phase, it is necessary to provide diversified design instruments which can be used at different levels: both in preliminary design phases and in executive design phases.

This subdivision is useful for both the legislative proposals regarding public works design (division of the design project in preliminary, definitive and executive phases), and for assisting enterprises' in their need to speed up the design process especially in the cost estimate forecast.

In the first case, we refer to design which, divided into three levels (preliminary, definitive and executive), requires the use pre-dimensioning techniques (less accurate, but necessary, in order to define the characteristics of the products used) and of verification techniques also which, although requiring a greater investment in terms of time and software instruments, guarantees a better forecast of the built objects' behaviour.

In the second case, we refer to the phase where the manufacturing Enterprises and/or installers of PCM containing building components, or the designers themselves, must carry out the feasibility studies or quick cost estimates; the need to use fast instruments in order to single out the type of product to be used, and consequently, the price range addressed is obvious. In this way, the field operators are guaranteed good competitiveness in relation to consolidated construction techniques, where the information coming from projects already built or from experiments can be used for quick estimates or for drawing cost estimates in the preliminary project. The same simplified calculation procedures can be used to estimate the energetic savings contribution made using the solution considered more opportune for the case in question.

Both the first parts and the second present different calculation instruments according to the type of technological problem which must be addressed. In general, we can affirm that two different methods were proposed for the PCM case for external and internal technological systems.

The simulation on the energetic behaviour of PCM containing buildings requires the use of different calculation techniques according to the problem faced, in particular the distinction is made between:

1. use of PCM for external buffering;
2. Use of PCM for application on interior built elements.

In the first case, the calculation procedure foresees an approach on two different levels, according to the energetic design needs: the verification of the energetic behaviour of each partition can be carried out to using the finite element approach, whereas the simulation of the energetic behaviour at the global level can be carried out to using the calculation method of the transfer functions. The first approach is more limiting as it is referred to a single element, but once assigned opportune boundary conditions it allows forecasting energetic behaviour in or out of a partition on that interfaces as well, in particular:

- the advance on the fusion and solidification of the PCM layer front can be read in function of time;
- the flow and temperature diagrams are provided not only for the external buffering finish, but for the interfaces as well;
- simulation can be carried out using two dimensional or three-dimensional "mesh" , hence it is not necessary that the layers be homogeneous, but discontinuity points are accepted;

- the approximation which, can be obtained in the behaviour forecast of the stratification layers were the insertion of a non -ventilated air layer is foreseen, is very good..

The innovation introduced as compared to the calculation procedures now consolidated in the energetic field consists in proposing instruments capable of considering the presence of PCM and its interaction with the neighbouring stratifications.

The second approach, regarding this study of buildings in their entirety, was faced using the transfer of functions calculation method, as it is the most used for carrying out “Whole Building Analysis” during the energetic design phase.

A calculation algorithm which overcomes the limits of those presently on the market that do not foresee the possibility of simulating the presence of PCM in the stratifications is proposed in a study of Polytechnic University of Marche.

By uniting the first and second approach it is possible not only to estimate the energetic savings entailed by the use of PCM, but it is also possible to carry out more detailed simulation in order to verify the behaviour of single partitions accurately, in the case where these present problems which must be dealt with more thoroughly.

In the case of PCM use for internal partitions, a calculation algorithm based on the finite difference technique which allows the simulation of an environment's temperature course in function of its geometric characteristics and the thickness of the PCM layer applied on the internal partitions.

6.5. Available experimental procedure to assess element performances

In the flowchart below is described a possible procedure to follow for a accurate study of an application of PCM and a valuation of the characteristics of a components that use Phase Change Material. In parallel of the study of the material and its characteristics, there is necessity to study the heat exchange concept, for improve the performance of the PCM. In fact one of the most problem of the using of PCM is the problem relating the load and unload of the energy, that agree the process of fusion and solidification. A experimental test, in laboratory and in field, is necessary a study of theoretical model and simulation method as tools for the study of the behaviour of this material and its possible applications. The confrontation of the experimental tests and the simulations, for example with software, can offer a method to know the accuracy of the experimental methods used.

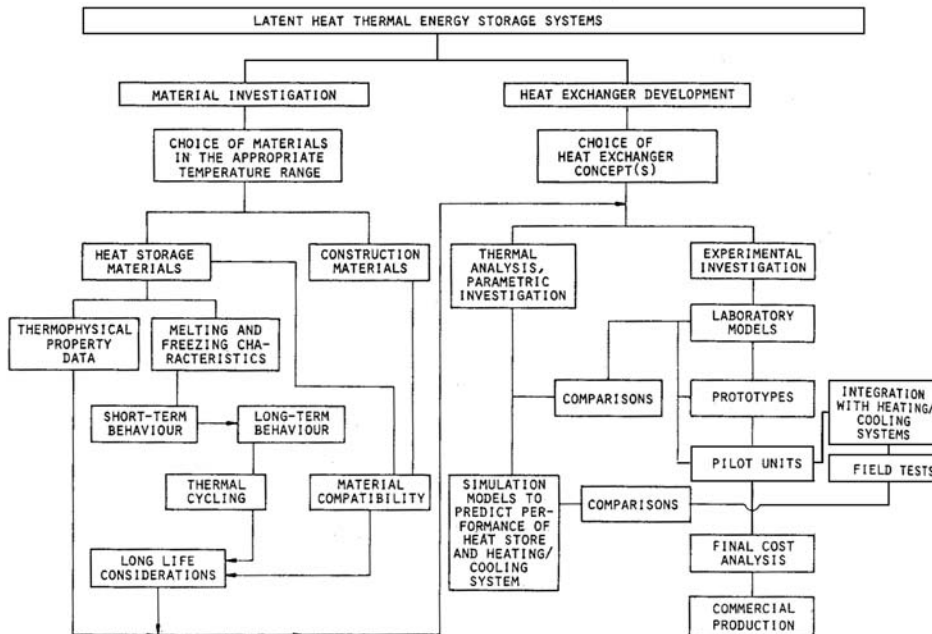

Fig.6.13: Flowchart providing an overview of a various steps in the development of a latent heat storage system.

6.5.1 Example of an experimental method of study

In this example we describe a procedure to validate a finite element algorithm for the simulation of a two dimensional problems of heat transfer with Phase Change, comparing the numerical results with the experimental ones deriving from tests carried out on two different kinds of PCM containing panels.

In this tests four prototypes of ready-made PCM containing panels were tested (two of them used to validate the numerical finite element method for design purposes) in a climatic chamber, capable of simulating several kinds of outdoor and indoor environmental conditions, aimed at evaluating their energetic performances, which make them suitable for use in different climatic contexts or in different elements of buildings.

A research group of the Polytechnic University of Marche is carrying out studies aimed at testing the suitability of using PCM to solve problems tied to the overheating of ready-made sandwich panels for lightweight buildings, already object of a three year experimentation within the framework of an European Commission funded CRAFT Project entitled C-TIDE (Changeable Thermal Inertia Dry Enclosures).

In these series of experiments, attention was directed to the analysis of the summer behavior of these prototypes of PCM containing sandwich panels, evaluating the response variability to temperature stress and high quantity radiation in order to differentiate its use according to climate and design requirements, aiming in each case to the same objectives: bettering comfort conditions and lowering energetic gains. The additional latent heat of fusion provided by PCM is used to increase the thermal capacity of lightweight construction; in this way it is possible to avoid the use of traditional heavy weight constructions that can give rise to problems of excessive thermal mass and cost, without renouncing to obtain high thermal inertia.

Moreover a two dimensional finite element method was developed to simulate the energetic behavior of these kinds of panel. In fact one of the main problems connected with the use of

PCM is the difficulty of forecasting, through the use of a numerical simulation tool, the thermal behavior of PCM containing building elements.

The experiments were held inside a test-room at the Laboratory of “Fisica Tecnica Ambientale” of the department of “Energetica” of the Polytechnic University of Marche. As previously stated, it is possible to simulate the desired climatic conditions within this test-room, relative to external and internal environments. The room consists of a load bearing structure measuring 4.37 m \times 3.39 m with a height of 2.70 m. The test-room is paneled with plaster board and polyurethane modules measuring 1.20 m \times 2.40 m and 0.04 m thick, while the roof is made up of dismantlable radiating system panels. The pavement is “floating” type placed 0.40 m above the laboratory floor, and it is made up of squared modules measuring 0.60 m \times 0.60 m, supported by adjustable zincate steel feet. In order to be designed with the concept of high flexibility, all the sides of the room present the removable panels high 0.40 m on the top and on the bottom, to install the grilles and to have different configurations and positions of air diffusion.

The test-room is fed from an aeraulic circuit constituted by rigid and flexible pipes of plastic material and other equipments described hereon. An air treatment unit supplies the air conditioning of the inlet air and controls all the thermal comfort parameters. It is connected with an air chiller condensing unit, with a 5.15 kW cooling power and equipped with all the hydraulic components needed for operating. The aeraulic circuit is completed by a Venturi nozzle for a full scale flow rate of 300 m³/h. The control of the test-room’s system is left up to a Programmable Logic Control (PLC), whereas the values of the temperature are recorded by the sensors (thermo-couples) located in the two volumes of the test-room, are acquired through an electronic ice point reference, where the thermocouples are connected to an electronic zero, and voltage is acquired by a 19 bit analogical/digital conversion system. The entire system allows the evaluation of the hundredth degree. Furthermore, the data relative to probes (e.g. to measure air and surface temperature, heat flux, air velocity and so on) are recorded using a data acquisition system.

For the present research purposes, the test-room was divided in two volumes through a partition made up of 0.10 m thick polystyrene panels. The prototypes were tested in sequence, assembled within the central part of the partition .

The partition separates the test-room into two parts, inside which were established climatic conditions typical of an internal environment and of an external one (summer conditions). Resistance Thermal Detectors (RTDs) were placed on the surface of the prototypes and on every interface.

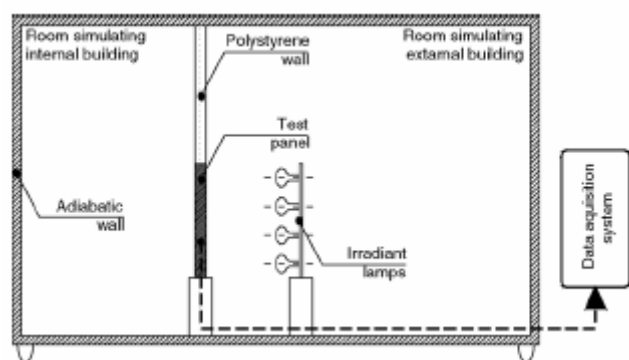
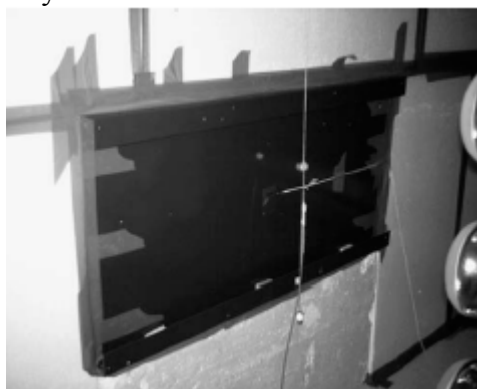

Fig. 6.14. the panel integrated in the wall, Diagram of the positioning of the panel, the solar simulator and the data acquisition system.

The numerical model was used for the simulation of prototypes. A finite element algorithm was used to describe the two-dimensional thermal conduction phenomenon which occurs within the PCM containing panels. For the aims of the work, the procedure was integrated in the COSMOS/M software.

The comparison was carried out for the two cases the percentage error made with the numerical simulation was computed at each time step of the numerical simulation, comparing it with the experimental case, relative to the RTDs positioned on the panels internal surface (TR1) and on the separation surface between the PCM and the polystyrene (TR3). In the first case, the mean of the shifts is equal to 0.37% with standard deviations of 0.24% and maximum error of 1.07%. In the second case, the mean was equal to 0.70%, with standard deviation of 0.98% and maximum error equal to 3.61%. Considering the low deviations from the average error obtained in the two cases, we can conclude on the very good reliability of the calculation algorithm for the simulation of PCM with two-dimensional finite element model in the case where we suppose that the phase change occurs in a 1°C range.

6.6. Availability of measured performances (labs. and field measurements)

About the utilising of the PCM in building application there are many study that describe the behaviour of these components. In these studies, different components are tested, with different procedure. The varieties of type of PCM, and the possible applications don't consent a standard procedure for the evaluation of characteristics.

There are many experimental test carry out in laboratories, experimental test with prototype buildings and the monitoring of the real buildings that utilising PCM technologies.

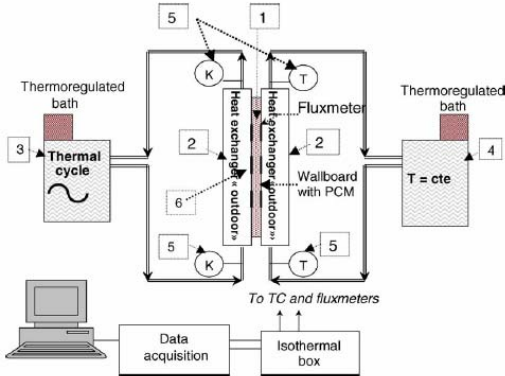

fig. 6.15: example of a experimental indoor laboratory test system .



fig. 6.16: prototypes of box for experimental test of façades with PCM layer.



fig. 6.17: example of an house with PCM façade technology.

6.7. Availability of simulated performances

Nowadays, there are different commercial programs for the thermal simulation of buildings: EnergyPlus, TRNSYS15, ESP-r, RADCOOL, DOE-2, IDA-ICE3, HVACSim, CLIM2000, and many others. Although all the possibilities of these programs, none of them have modules that allow direct simulation of the effect of adding a PCM in a wall or window.

While analytical models of several PCM building elements are available, very few authors have worked on the simulation of the effect of PCM in buildings using whole thermal building simulation programs (Peippo et al., Feustel and Stetiu, Jokisalo et al, Schossig et al). Peippo et al. were one of the first to discuss the use of PCMs walls for short-term heat storage in a building simulation environment. In their proposal all surfaces of the south-facing direct-gain room excluding the floor were covered by PCM panels. The PCM considered was fatty acid impregnated into conventional 13 mm-thick plasterboard. The energy simulation balances were analysed by the code FHOUSE (Aro-Heinil and Sunanen). Owing to computational limitations, the effect of latent heat of the PCM was accounted for by defining an effective specific heat capacity. The project from Feustel and Stetiu studied the use of PCM imbedded in gypsum wallboards. A functional description of the specific heat was implemented into some of the wall modules available for the program RADCOOL.

The paper by Jokisalo et al. include the model of a concrete wall that contains macroencapsulated PCM, that is, tubes filled with a hydrated salt. The mathematical model of this wall is included to the component of TRNSYS14.2 (Beckman et al.) that simulates the behaviour of a single room.

These algorithms cannot be easily included in simulations of more complex buildings with different zones. The project from Schossig et al. is about microencapsulated PCM mixed with

gypsum for interior wall application. The authors implemented the possibility to calculate non linear thermal properties of construction materials in the simulation environment ESP-r (Clarke).

6.8. “Claimed” benefits

Energy storage in the walls, ceiling and floor of buildings may be enhanced by utilising Phase Change Materials. PCM can absorb solar energy at daytime while PCM changes from solid to liquid, and releases the energy and freezes back to solid when the room temperature falls down at evening. Therefore, the human comfort level can be increased by using PCM to lower indoor air temperature fluctuation and maintain the indoor air temperature to the desired range for a longer period. Phase change materials can provide large latent heat storage over the narrow range of temperature typically encountered in buildings, thus they can improve the thermal comfort degree. Utilization of the latent heat is one of the most efficient means of heating due to a high capacity of heat storage at a constant temperature of the storage medium.

The use of PCM (Phase Change Materials) in the construction field aims to be a solution for the control of thermal flows and the exploiting solar energy by using its enormous capacity for accumulating heat around temperatures close to its melting point. In effect, by exploiting their latent fusion heat, and in smaller part, their specific heat, these materials act as heat accumulators; absorbing and discharging heat keeping their temperature unaltered and thus avoiding the overheating of the elements they are contained in.

6.9. Barriers to application and limitations

The main problems encountered have to do with the determination of the characteristics of the PCM layer (thickness and melting point) and the evaluation of the external layer's (that absorbs solar radiation) important characteristics, trying to eliminate the effect of daily solar radiation by using the PCM layer.

The choice of the stratification and functional model, considering the climate context, type of building and the orientation of the wall surface is very important for having a desired performances of the PCM.

Furthermore the application of the phase change materials are subject to two fundamental restrictions: firstly, the heat transfer between the air and the wall limits the maximum storage power within a day/night cycle; secondly, the application is fully dependent on the outdoor temperature of the night air as a heat sink. In some building types or under certain climatic conditions, these restrictions appreciably limit the applicability of such materials.

An important limitation of the use of some kind of PCM, for example the inorganic hydrates salt is the durability of these substances.

The principle problem attributed to these salts, but on the other hand to hydrate salts as well, lies in performance loss with repeated thermal cycles, which entails a substantial lowering of their storage and discharge capacity during phase change. This phenomenon cannot be ignored as already after 20 – 40 cycles' latent heat passes from 238 kJ/kg to 63 kJ/kg diminishing over 70%.

The possibility to use PCM in the building industry can be realistic if its performance in time can be stabilized in order to control them and keep them unchanged. In order to do so we

must first and foremost observe and evaluates all the phenomenon which determine their loss of storage capacity and deterioration in time.

6.10. References

- Abhat A(1983) *Low temperature latent heat thermal energy storage: Heat storage materials Solar Energy, Volume 30, Issue 4, 1983, Pages 313-332*
- A. Abhat et al., *Development of a modular heat change with an integrated latent heat store. Report no. BMFT-FT-T-081-050, German ministry for science and technology, Bonn,FRG (1981)*
- Ames D.A.(1989) *The past,present, and futur of euctectis salt storage systems Ashrae journal maggio 1989 pp 26-28*
- Athienntis K.(1997) *investigation on thermal performance of passive solar test rom with wall latent heat storage. Building and environment vol. 32 no.5 pp 405-410,1997.*
- AL Jandal S.S., Sayigh A.A.M. (1994) *Thermal performance characteristic of STc system with phase change storage. Renewable Energy, Volume 5, Issues 1-4, August 1994, Pages 390-399*
- Bernard N.(2002) *Thermal mass and night ventilation utilising "hidden thermal mass". Internation journal of ventilation Vol. 1 no 2 october 2002 pages 81-90.*
- Berecarrats J.P, Strub F, Falcon B, Bumaz J.B (1996) *Phase change thermal energy storage using spherical capsules: performance of a test plant. International journal of refrigeration Vol. 19, issue 3, pp187-196*
- Biswas D.R.,*thermal energy storage using sodium sulphate decahydrate and water. Solar Energy 19, pp 99-100 (1977)*
- P. Brousseau and M. Lacroix (1996) *Study of the thermal performance of a multi-layer PCM storage unit. Energy conversion and management. Vol 37, issue 5, pages 599-609.*
- Brown R.C,Rasberry J.D, Overmann S.P (1998) *microincapslated phase change materials as heat transfer media in gas fluidized beds. Powed Technoogy Vol.98, issue 3 pages 217-222*
- Buddhi D, Bansal N.K, Sawhaiey R.L, Sodha M.S (1998) *Solar thermal storage systems using phase change materials. International journal of energy researh Vol. 12, issue 3.*
- Bugase I.M (1997) *Enhancing the thermal response of latent heat storage systems. International journal of energy reserch. Vol 21, Issue 9, pp 759-766.*
- Cabeza L.F, Illa J, Badia F, Roca J, Meheling H, Heibler S, Ziegler F (2001) *Immersion corrosion tests on metal- salt hydrate pairs used of latent heat storage in the 32 to 36 C temperature range. Materials and corrosion. Vol. 52. Pages 140-146*
- Cabeza L.F, Meheling H, Hiebler S, Zieder F (2002) *Heat transfer enhancement in water when used as PCM in thermal energy storage. Applied thermal engineering. Vol. 22,*

issue 10, pages 1141-1151

- Carlsson B, H.Stymne and G.Wettermark, *An incongruent heat of fusion system CaCl₂ made incongruent through the modification of the chemical composition of the system. Solar Energy* 23, 343-350 (1979)
- Chandra S, Kumar R, Kushik S, Kaul S (1985) *Thermal performance of a non-air-conditioned building with PCCM thermal storage wall. Energy Conversion and Management, Volume 25, Issue 1, 1985, Pages 15-20.*
- Chahroudi D(1975). *suspension media for heat storage materials.Proc. workshop on Solar Energy Subsystem for the heating and cooling of buildings. Charlottesville.Virginia USA, 56-59.*
- Carlsson B.O, Hans S(1978) *Gunnar Wattermark D12:1978, Storage of low temperature heat in salt hydrate melts calcium chlorid hexahydrate. Swedish council for building research.*
- Collier R.K, Grimmer D.P (1979) *The experimental evacuation of phase material building walls using small passive test boxes. 3rd passive solar conference.*
- Das S, Dutta T.K (1993) *Mathematical modelling and experimental studies on solar energy storage in phase change material. Solar energy. Vol. 51, issue 5 305-312.*
- Eames I.W, Adref K.T (2002) *Freezing and melting of water in spherical enclousures of the type use in thermal (ice) storage system. Applied. Thermal engineering, Volume 22, pages 733-755.*
- Edie D.D. et al.(1979) *Latent heat storage using direct contact heat transfer. In Sun II (Edited by K.W. Boer and B.H. Glenn) pp 640-644 Pergamont Press, New York*
- Erk Henry F, Dudokovic M(1996) *Phase change heat regeneration: modelling and experimental studies. AichE journal, Volume 42, no. 3 mars 1996, pp 791-808.*
- El Dessourky H.T, Bouhambra W.S, Ettouney H.M, Akbar M(1996). *Heat transfer in vertically aligned phase change energy storage system. Journal of solar energy engineering. Translaction of the ASME, Volume 121, no,2, pages 98-109.*
- Enibe S.O(2002) *Performance of a natural circulation solar air heating system with phase change material energy storage. Renewable Energy, Volume 28, Issue 14, November 2003, Pages 2269-2299*
- Farid M.M, Hamad F.A, Abu Arabi M(1998) *Melting and solidification in multidimensional geometry and presence of more than one surface. Energy conversion and management, Volume 39, issue 8, pages 809-818.*
- Farid M.M, Kanzawa A(1989). *Thermal performance of heat storage module using PCM's with different melting temperatures: mathematical modelling. Journal of solar energy engineering, volume 111, no. 2, pages 152-157, may 1989.*

- Feldman D, Banu D(1996). DSC analysis for the evacuation of an energy storing wallboard. Thermochemica ACTA, Volume 272, pp 243-251.*
- D. Feldman, D. Banu, D. Hawes and E. Ghanbari(1991) Obtaining an energy storing building material by direct incorporation of an organic phase change material in gypsum wallboard. Solar energy materials, Volume 22, Issues 2-3, Pages 231-242 (July 1991).*
- Flashman R(1999). Energy storage using a phase change materials in a domestic dwelling.*
- Furbo S(1981), Heat storage with an incongruently melting salt hydrate as storage medium. In thermal Storage of solar energy (Edited by C. Den ouden), pp 135-146, Nijhoff, The Hague (1981)*
- Gates J, Ip K, Miller A(2002) Experimental models for solar thermal storage for the sustainable heating of residential buildings. CIB sustainable buildings conference 2002 Oslo. September 2002.*
- Hadjieva M, Stoykov R, Filipova TZ(2000). Composite salt-hydrate concrete system for building energy storage. Renewable Energy, Volume 19, Issues 1-2, 2 January 2000, Pages 111-115*
- Hadman M.A, Elwerr F.A(1996). Thermal energy storage using a phase change materials. Solar energy, Volume 56, issue 2, pages 183-189.*
- Hasnin S.M(1998P). Review an sustainable thermal energy storage technologies part I, heat storage material and techniques. Energy convention and management, Volume 39, no.11, pp. 1127-1138*
- Hawes D.W, Feldman D, Banu D(1993) Latent heat storage in buildings materials. Energy and buildings, Volume 20, no. 1, pp77-86*
- Hawlander M.N.A, Uddin M.S, Zhu H.J(2002) encapsulated phase change materials for thermal energy storage experimental and simulation. International journal of energy research, Volume 26, issue 2, pages 159-171.*
- Imperadori, M.; Masera, G.; Lemma, M. – Super-efficient energy buildings, Proceedings of XXXI IAHS World Congress on Housing, Montreal, Canada, 2003.*
- Ip K, Gates J.R(2001) solar thermal storage using phase change materials for space heating of residential building.*
- Ip K, Gates J.R(2000). Thermal storage for sustainable dwellings, international conference sustainable buildings 2000, 22-25 october Maastricht, Netherlands.*
- IP K(1998) Solar thermal storage with phase change materials in domestic buildings. CIB World congress. Gävle, Sweden 7-12 june, pp 1265-1272*
- Ismail K, Goncales M.M(1999) Thermal performance of a PCM storage unit. Energy conversion and management, Volume 40, issue 2 january 1999, pages 115-138.*

- Jar A, Kaygujuz K(2003) *Some fatty acids for latent heat storage: thermal stability and corrosion of metals with respect to thermal cycling. Renewable energy, volume 28, issue 6, pages 939-948.*
- Jalyer IO, Sircar A.K(1997) *review of phase change materials research for thermal energy storage in heating and cooling applications at the university of Payton from 1982 to 1996. International journal of global energy issue, Volume 9 issue 3, pages 183-198.*
- Jalyer IO, Sircar A.K(1990). *Phase materials for heating and cooling of residential buildings and other applications. Proceedings of the intersociety energy conversion engineering conference, Volume 4,1990. Proceedings of the 25th intersociety energy conversion engineering conference-IECEC '90, 12-17 agosto, Reno NV, USA, pages 236-243. ISSN:0146-955*
- Jianfeng Wang, Guangming Chen, Haobo Jiang (1999) *theoretical study on a novel phase change process. International journal of energy research, No. 23, issue 4, pages 287-294.*
- Kang Yan Bing, Jiang Yi, Zhan Yinping(2003) *modelling and experimental study on an innovative passive cooling-NVP system. Energy and buildings, Volume 35, issue 4, pages 417-425.*
- Kedt R.S, S.T.K(1989). *Activies in support of the Wax-impregated wallboard concept. U.S. departement of energy thermal storage research activities review, New Orleans, lousiana, U.S. department of energy.*
- Kim J.S, Darkwa K(2003) *Simulation of an integrated PCM-wallboard system. International journal of energy research, Volume 27, issue 3, pages 215-223.*
- Kissok K(1998). *Early result from testing phase change wallboard. IEA Annex 10, first workshop 16-17 april 1998 Adana, Turkey.*
- Kniep R, Laumen M, Zachos A(1985). *Latent heat stores and phase change materials, an extensive area for thermal analisys, calorimeter and chiminal thermodynamics. Thermochemica ACTA, Volume 85 pp 131-134.*
- Kurklu A(1998). *Short-term thermal performance of a build-in storage for frost prevention in greenhouse. International journal of energy research. Volume 22 pages 169-174.*
- Kurklu A(1998) *energy storage application in greenhouse by means of phase material change: a review. Technical note. Renewable energy, volume 13, pages 89-103.*
- Kurklu A, Wheldon A, Hadley P(1996) *Mathematical modelling of thermal performance of a thermal performance of a phase change material (PCM) stor cycle. Applied thermal engineering, Volume 16, issue 7, pages 613-623.*
- Kurklu A, Ozmerzi A, wheldon A, Hadley P(...). *Use of a phase change materials (PCM) for reduction of peak temperatures in a model greenhouse. ISHS ACTA hoticulturae 443: international conference on green house technoligies.*

- Lee T, Hawes D.W, Banu D, Feldman D(2000) Control aspects of latent heat storage and recovery in concrete. *Solar energy materials and solar cells, Volume 62, issue 3, pages 217-237.*
- Lemma M., Fioretti R., Imperadori M.(2005), *Development of a technology for inserting a PCM layer in building envelopes, Atti del XXXIII IAHS World Congress "Housing, Process & Product", Pretoria 2005;*
- Lemma, M.; Torcianti, N.; Imperadori, M.; Masera, G.(2003) – *Gli involucri sensibili: progetto e costruzione di pareti ventilate ad inerzia variabile (Sensible envelopes: design and construction of ventilated façades with variable inertia), Proceedings of international symposium "Involucri quali messaggi di architettura" ("Building envelopes as architecture messages"), Naples, Italy, 2003.*
- Lemma, M.; Imperadori, M. (2002)– *Phase Change Materials in concrete building elements: performance characterisation, Proceedings of XXX IAHS World Congress on Housing, Coimbra, Portugal, 2002.*
- Lou D.Y(1983) *solidification process in a gluber salt mixture. Solar energy, Volume 30, issue 2, pages 115-121.*
- Lorsch H.G., K.W. Kaufmann and J.C.Denton, (1975) *Thermal energy storage for solar heating and off-pek air-conditionning. Energy conversion 15,pp 1-8*
- S.Marks (1983), *The effect of crystal size on the thermal energy storage of thickened Glauber's salt, Solar Energy Vol.30, pp.45-48.*
- Marks S(1980). *An investigation of Gluber's salt with respect of thermal cycling. Solar Energy 25,pp 255-258 .*
- Min Xiao, Bo Feng, Kecheng Gong(2002). *Preparation and performance of shape stabilized change thermal storage materilas with thermal conductivity. Energy conversion and management. Volume 43, issue 1, pages 103-108.*
- Manz H(1997) *TIM-PCM external wall system for solar space heating and daylighting. Solar energy, Volume 61, issue 6 pages 369-379.*
- Merritt R.H, Ting K.C(1995). *Morphological pesponcse of bedding plants to tree greenhouse temperature regime. Scientia orthicolturae, Volume 60, pages 131-324*
- NG K.W, Gonz Z.X, Mujumdar A.S(1998) *Heat transfer in free convection dominated melting of a phase change materials in a horizontal annulus. International journal of eat and mass transfer, Volume 25, issue 5, pages 631-640.*
- Neeper D.A(1989) *Potential benefit of distribued PCM thermal. American solar energy society.*
- Neeper D.A(2000). *Thermal dynamics of wallboard with latent heat storage. Solar energy, Volume 68, issue 5, pages 393-403.*

- Peippo K, Kauranen P, Lund P.D(1991). *Multicomponent PCM wall optimized for passive solar heating. Energy and buildings. Volume 17, issue 4, pages 259-270*
- Pearson F.J(1989) *The chiller air approaches in the office buildings market. ASHRAE journal, may 1989, pages 259-270.*
- Principi, P.; Di Perna C.; Carbonari, A.; Borrelli, G. (2005)– *Experimental energetic evaluation of changeable thermal inertia PCM containing walls, Passive and Low Energy Cooling for the Built Environment, (PALENC 2005), Santorini Island, Greece, 2005.*
- Principi, P.; Di Perna C. (2004)– *First theoretical and experimental data referred to the energetic behaviour of building component utilising Phase Change Materials, Proceedings of 5th International Congress Energy, Environment and Technological Innovation (EETI 2004), Rio de Janeiro, Brazil, 2004.*
- Principi, P.; Di Perna C.; Carbonari, A.; Borrelli, G. (2005)– *Monitoring system for the evaluation of the energetic behaviour of PCM containing walls, Passive and Low Energy Cooling for the Built Environment, (PALENC 2005), Santorini Island, Greece, 2005.*
- Principi, P.; Di Perna C.; Carbonari, A.; Ferrini, M., (2004), – *Validation of Numeric finite Element Calculation Model Through the Laboratory experimentation of Artificial Programmable Inertia Walls, Proceedings of XXXII IAHS World Congress on Housing, Trento, Italy, 2004.*
- PY X, Olives R, Maurans(2001) *Paraffin porous-graphite-matrix composite as a high and constant power thermal storage material. International journal of heat and mass transfer. Volume 44, pages 2727-2737.*
- Rudd A.F.(1993). *Phase materials change wallboard for distributed thermal storage in buildings. ASHRAE Transaction research, Volume 99, part 2, paper 3724.*
- Ruyon L, Guiffant G, Flud P(1997). *Investigation of heat transfer in a polymeric phase change materials for low level heat storage. Energy conversion and management, Volume 38 issue, pages 517-524.*
- Santamouris M.S, Lefas C.C(1988). *On the coupling of PCM stores to active solar system. International journal of energy research, Volume 12, issue 4, pages 603-610.*
- Sasaguchi K, Viskanta R(1989) *Phase change heat transfer during melting and resolidification of melt around cylindrical heat source/sink. Journal of energy resources technology, volume 111, issue 1, pages 42-49.*
- Scalat S(...) *full scale thermal testing of latent heat storage in wallboard. Solar energy materials and solar cells, volume 44, pages 49-61.*
- Schröder J., R. And D(1980). *system for thermal energy storage in temperatures range from –*

- 25 C to 150 C. *Proc. Seminar new ways to save energy*, 495-504, Reidel, Dordrecht,
- Sharma Atul, Sharma S.D, Buddhi D, Sawhney R.L(2001). *Thermal cycle test of urea for latent heat storage applications. International journal of energy research*, Volume 25, issue 5, pages 465-468.
- Stetiu C, Feuster H.E. *Phase change wallboard and mechanical night ventilation in commercial buildings [on line]* <http://oxford.elsevier.com>
- Stetiu C, Feuster H.E(1996) *Phase change materials wallboard as an alternative to compressor cooling in California residences. In proceedings: 96 ACEE Summer study for energy efficient buildings. Silomar, California.*
- Stritih U, Novak P(1996) *Solar heat wall for building ventilation. Renewable energy*, Volume 8, issues 1-5, pages 268-271.
- Stoval T.K, Tomlison J.J(1992) *What are the potential benefits to including latent storage in common wallboard. Proceeding of the intersociety energy conversion engineering conference V4, 1992, energy system – new technologies. Proceedings of the 27th intersociety energy conversion engineering conference, August, 3-7, 1992, San Diego, CA, USA, 929371, pages 265-270. ISSN:0146955X, ISBN 1-56091-264-2.*
- Stymne H(1980) *Improvement of the efficiency of energy transformation processes utilising a chemical heat pump. International seminar of thermochemical energy storage. Stockholm, January 7-9, 1980. Arranged by Royal Swedish Academy of Engineering.*
- Telkes M. (1952). *Nucleation of supersaturated inorganic salt solution. Industrial and engineering Chemistry* 44, pp 1308-1310
- Telkes M(1975). *Thermal storage for solar heating and cooling. Proc. Workshop on solar energy storage subsystem for the heating and cooling of buildings, pp 17-23, Charlottesville, Virginia, USA*
- Tomlinson J.J, Herberle D.D(1980) *Analysis of wallboard containing a phase change material. Proceedings of the intersociety energy conversion engineering conference, IECEC '90, August 12-17 1990 NV, USA, pages 230-235*
- Ulfrengen Rolf, Climator AB(1998) *the application of PCM technologies in telecommunications. IEA annex 10. First workshop. April 16-17 1996, Adana, Turkey.*
- U.S. department of energy(2000). *Phase change drywall.* <http://www.eene.doe.gov/consumenfo.refbiefs/db3.html>
- U.S. department of energy(2000). *Phase change materials for solar heat storage.* <http://www.eene.doe.gov/consumenfo.refbiefs/b103.html>
- Velrias R, Seenrias R.V, Hafner B, Faber C, Schwarzer K(1999) *heat transfer enhancement in a latent heat storage system. Solar energy*, Volume 65, issue 3, pages 171-180.
- Vandini M(1990) *The HVAC system choice with cool storage. Energy engineering*, Volume

87, issue 6, pages 34-45.

Wang Jianfeng, Chen Guangming, Chen Goubang, Ouyang Ying Iu (2000). *Study on charging and discharging rates of latent heat thermal energy storage systems employing multiple phase change materials*. *Taiyangneng Xeubao/Acta energiae solaris sinica*, Volume 21, issue 3, pages 258-260.

Wattermarx G, Carlsson B, Stymne H(1979) *Storage of heat. A survey efforts and possibilities*. Document D2:1979. Swedish council for buildings research.

Xiao M, Feng B, Gong B(2002) *Preparation and performance of shape stabilized phase change thermal storage material with high thermal conductivity*. *Energy conversion and management*. Volume 43, issue 1, pages 103-108.

Yamagishi Yasushi, Takeuchi Hiromi, Pyatenko Alexander A, Kayukawa Naoyuki (1999) *characteristics of microencapsulated PCM slurry as a heat-transfer fluid*. *AichE journal*. Volume 45, issue 4, pages 696-707.

Yiuping Z, Yi S(1999) *A simple method, the T-History method of determining the heat of fusion, specific heat and thermal conductivity of phase change materials*. *Measurement science technology*, Volume 10, pages 201-205

Yinping Zhang, Yi Jiang, Kang Yanbing, Zhong Zhipeng. *Research of latent heat storage in Tsinghua university and application of ice storage in China*. http://www.ket.kth.se/advelningar/ts/annex10/ws_pres/wsz/zhang.pdf

Zelba Belen, Marin Jose M, Cabeza Luisa F, Mehling Harald (2003) *review on thermal energy storage with phase change materials, heat transfer analysis and applications*. *Applied thermal engineering*, Volume 23, issue 3, pages 251-283.

Zambelli, E.; Imperadori, M.; Maserà, G. (2004)– *Artificial programmable inertia for low-energy buildings: integrating Phase Change Materials in building components*, *Proceedings of XXXII IAHS World Congress on Housing, Trento, Italy, 2004*

Zambelli, E.; Imperadori, M.; Maserà, G.; Lemma, M. (2003)– *High energy-efficiency buildings*, *Proceedings of the 4th international symposium on Heating, Ventilating and Air-conditioning ISHVAC 2003, Beijing, China, 2003*.

Published 2008 by
Aalborg University
Department of Civil Engineering
Sohngaardsholmsvej 57,
DK-9000 Aalborg, Denmark

ISSN 1901-726X
DCE Technical Report No. 051